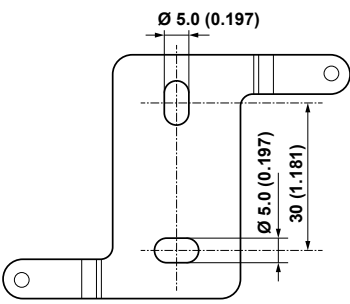
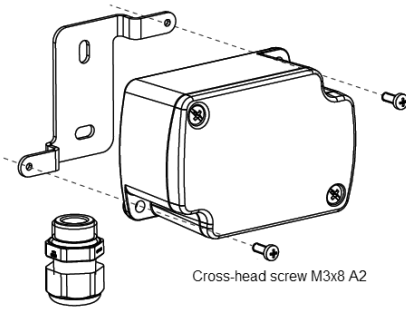

Temperature sensors Ni1000 from SBC

<p>OUTDOOR TEMPERATURE SENSORS AF01-B54, AF01-B65</p>	<p>CABLE IMMERSION TEMPERATURE SENSORS KTF01-65-2M</p>
<p>DUCT TEMPERATURE SENSORS LF01-1B54, LF01-3B54, LF01-1B65, LF01-3B65</p>	<p>SNAP ON TEMPERATURE SENSORS SF01-B54, SF01-B65</p>
<p>IMMERSION TEMPERATURE SENSORS VF01-1B54NW, VF01-3B54NW, VF01-5B54NW VF01-1B65NW, VF01-3B65NW, VF01-5B65NW</p>	<p>WELLS for VF01-xBxxNW types See HONEYWELL: G12-100 and GF12-250</p>

Mounting of AF01-B54 and AF01-B65

<p>Step 1 - out of the box</p> 	<p>Step 2 - fix the bracket</p> 	<p>Step 3 - fix the plastic housing</p>  <p>Cross-head screw M3x8 A2</p>
--	---	---

Mounting of LF01-1B54, LF01-3B54, LF01-1B65 and LF01-3B65

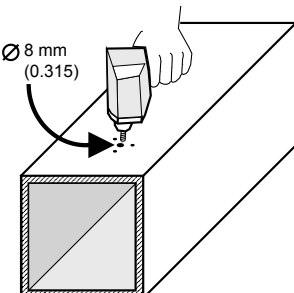
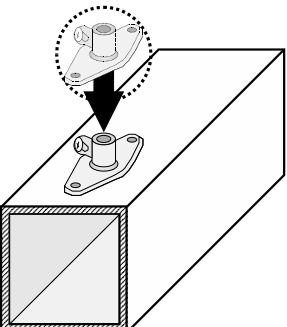
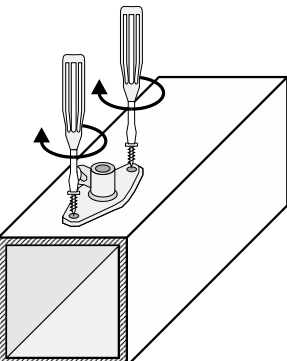
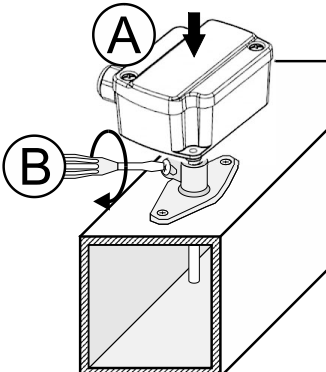
<p>Step 1</p> 	<p>Step 2</p> 	<p>Step 3</p> 	<p>Step 4</p> 
--	--	---	--

Mounting of SF01-B54 and SF01-3B65

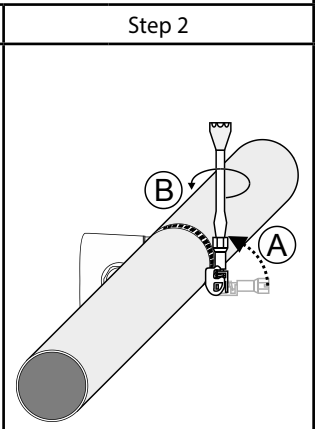
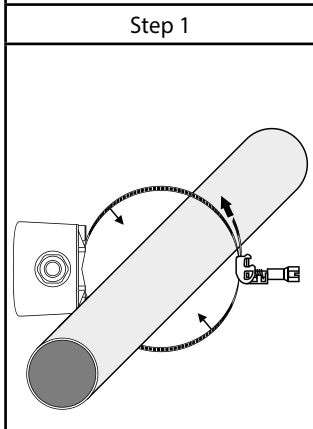

Mounting of VF01-xBxxNW

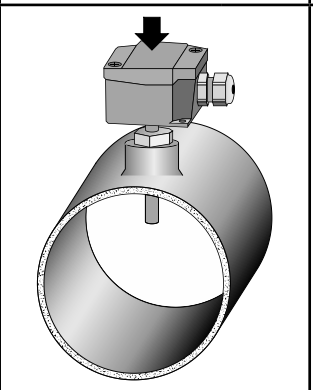

Mounting of KTF01-xx-2M

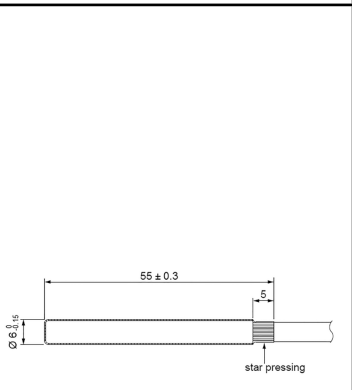

Wiring

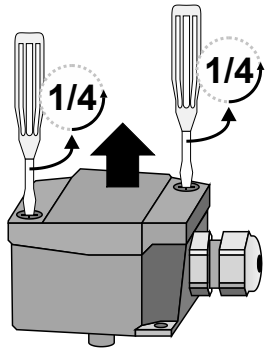
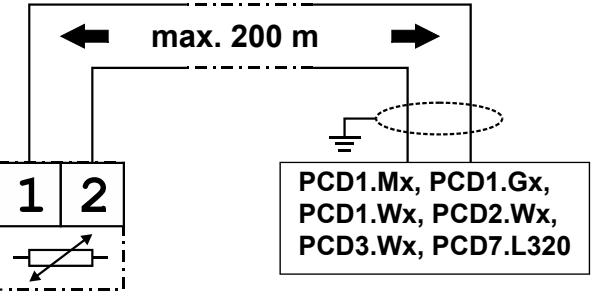
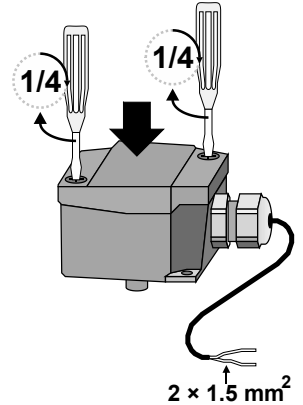
<p>Step 1</p> 	<p>Step 2</p> 	<p>Step 3</p>  <p>2 x 1.5 mm²</p>
---	--	---

Saia-Burgess Controls AG

Bahnhofstrasse 18 | 3280 Murten, Switzerland
 T +41 26 580 00 00 | F +41 26 580 34 99
 www.saia-pcd.com

support@saia-pcd.com | www.sbc-support.com