

# Reference Projects 2012



## Facility Infrastructure

Country	Project	Objecttype
CHN	New extension of RenJi Hospital, PuDong District	Hospital
CZE	OBI Market Trutnov	DIY Store
FRA	Building construction a brezillion's head office	Building
FRA	Energy solution in student housing	Housing
FIN	Renewing and old Building/ Senate Property	Heavac installation
GER	Training facility for fire-fighters using self contained breathing apparatus (SCBA)	Fire and smoke simulation room
GER	Zoo of future	Zoo
HUN	Automation of the Medicina clinic in Héviz	Clinic
HUN	Automation reconstruction of a regional hospital in Békéscsaba	Hospital
ITA	High demanding application for Hvacse of SPA, fitness & swimming pool, conference rooms and reception/hall	Hotel
ITA	Air conditioning plant renovation in a 4-stars hotel	Hotel
ITA	Control, regulation and communication of Minin shop's systems	Fashion shop
NED	Production and development of cranes and Swisscom Hospitality's Smart Room Controls @ citizenM London Bankside	Hotel
NED	Office renovation	Building
POL	New energy efficient hotel and spa in the seaside resort	Hotel
POR	Serralves Foundation in Porto	Building
SUI	Hotel control with touch screens and SBC App	Hotel
SUI	Area of Stücker – CO <sub>2</sub> neutral energy production and distribution on 70.000m <sup>2</sup>	Building
SUI	Residential development and commercial buildings	Building
SWE	Energy saving in municipal housing	Housing

<b>Object</b>	<b>Number of CPUs</b>	<b>Number of HW I/Os</b>	<b>Energy Management</b>	<b>Page</b>
SunCytek	42	3.500		<b>68</b>
OBI Česká republika, s.r.o.	2	486		<b>54</b>
Cr System	6	2.400		<b>20</b>
Crous of Clermont Ferrand	2	158	x	<b>18</b>
Senaati Kiinteistöt	7	1.160		<b>64</b>
Kreisfeuerwehrverband Roth	1	70		<b>36</b>
Zoo Hannover GmbH	23	2.422		<b>70</b>
Medicina clinic	3	144		<b>46</b>
Hospital Békéscsaba	9	896		<b>62</b>
Grand Hotel Del Mare Bordighera (IM)	1	575		<b>24</b>
Grand Hotel Hermitage	12	1.100		<b>26</b>
Minin	2	500		<b>50</b>
CitizenM	1	25	x	<b>14</b>
Leger des Heils Utrecht (Salvation Army)	2	117		<b>38</b>
Mera	18	1.000		<b>48</b>
Serralves Foundation	38	2.800		<b>66</b>
Hilton Worldwide	18	1.500		<b>32</b>
IWB – Industrielle Werke Basel	21	2.200	x	<b>34</b>
Suurstoffi Risch Rotkreuz	21	2.200		<b>70</b>
MKB Fastighet AB	200	15.000	x	<b>52</b>

# DIRECTORY

Country

Project

Objecttype

## Industrial Infrastructure

CHN	Hevac optimization with S-Monitoring	Hevac installation
GER	Production and development of cranes and large sunshade constructions	Industrial Sites
NOR	Building automation in rebuilt process industry	Building
SLO	Update automation in the process industry	Factory of roof systems

## Central Energy Production

GER	Biogas plant Cavertitz	Biogas plant
SUI	Reference district heating Groupe E SA	District heating

## Miscellaneous

GER	Optimising and controlling one of the worldwide biggest satellite broadcasting installation	Satellite technology
ITA	Renewing the depuration plant of the city of Cesena	Water sewage plant
NED	Securing the supply and distribution of drinking water	Pumpingstation
SUI	The way from "Not Lean" to "Lean"	Tunnel

<b>Object</b>	<b>Number of CPUs</b>	<b>Number of HW I/Os</b>	<b>Energy Management</b>	<b>Page</b>
Parlex	1	50	x	<b>58</b>
Liebherr-Werk Ehingen GmbH	61	80.000	x	<b>40</b>
Øra Industri Park	2	100	x	<b>56</b>
Bramac d.o.o.	2	350		<b>12</b>

Peter Hühnlein & Sohn GbR	1	80	x	<b>60</b>
Groupe E SA	250	n/a	x	<b>28</b>

MEDIA BROADCAST GmbH	10	6.000	x	<b>44</b>
IDEA	30	2.500		<b>30</b>
Dunea	6	128		<b>22</b>
BLS	720	100.000		<b>6</b>



▲  
One of 8 tunnel caverns:  
The air conditioned steel  
containers contain the rail  
control systems.  
One of the 104 cross tubes:  
In each, up to 15 control  
cabinets are installed.  
Air conditioning  
in the tunnel caverns

## Lötschberg base tunnel: The way from "Not Lean" to "Lean"

Operator: BLS  
Object: Tunnel  
Country: Switzerland



### Lötschberg base tunnel: The way from „Not Lean“ to „Lean“

After only two years of operation the railway company BLS decides the project „new tunnel management and control system“. The errors from construction phase should be corrected.

After the transfer to the operator BLS, the builder has been praised and rewarded: He has met all requirements regarding cost and schedule.

### Lötschberg base tunnel: Object description and tasks

- ▶ Tunnel characteristics:
  - Length of the tunnel 34.6 km  
(third longest tunnel in world)
  - Number of cross tubes 104
  - Temperature in tunnel 35 °C
  - Humidity in tunnel >80%
- ▶ Construction period: 1999–2007 (8 years)
- Client/Builder Swiss Confederation
- Operator BLS <http://www.bls.ch>
- Costs CHF Mio. 4'300
- ▶ Task:
  - The top priority for the builder was the compliance of costs and deadlines.

Project	Plan	Implement	Operate
Owner	😊	😊	😞
Planners/Arch.	😊	😊	no longer involved
Buyers/GC		😊	no longer involved
Operators	not involved		😞
Technicians	not involved		😞

Impressif example of contrasting interests between Builders and operators of technical infrastructures.



▲ Two single track tubes connected by cross tubes all 333m South portal near Visp (Wallis)

**Lötschberg base tunnel: Planning, Realization**

Planner and builder were under cost and time pressure. They did not fully know the operational requirements. The operational aspects were hardly heard - no time. The assignment of the individual parts has been made on cost and schedule only. They installed what was to get cheap and fast. All individual parts meet the specification, the tunnel works. The builder has done their job - and passed the infrastructure to the operator. Out of sight – out of mind.

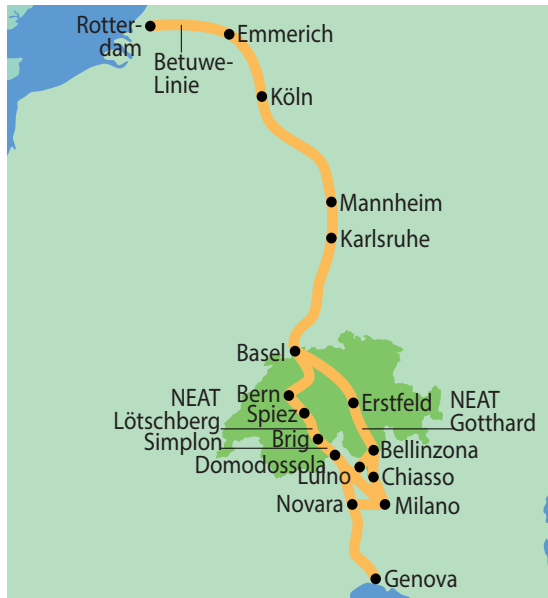

▲ As part of the Europe an high speed rail network between Frankfurt/Main and Milano the alps crossing base tunnel is the core.

◀ Ignorance in planning and implementation towards operation – all know it, but do not act.

**Unrealistic, wishful thinking as the basis for current processes/standards:**

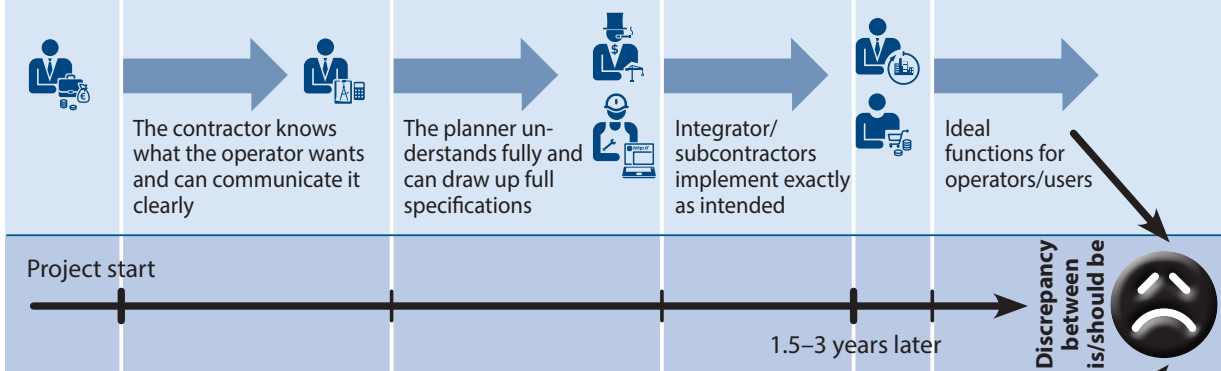

**The reality is constantly repressed and ignored:**

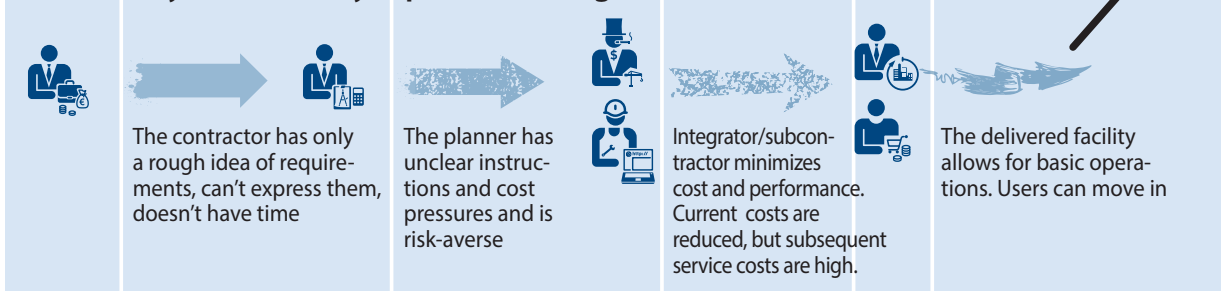

**Realization 1999–2007**

The technical infrastructures has been written out and realized as separate parts.

- Fire protection
- Ventilation/Cimatization
- Radio network
- Lighting
- Evacuation

- Video surveillance
- Cross tube doors
- Water supply

The tunnel was completed on schedule and within budget.

▲ On Lötschberg has happened what is common in planning and implementation of technical infrastructures.

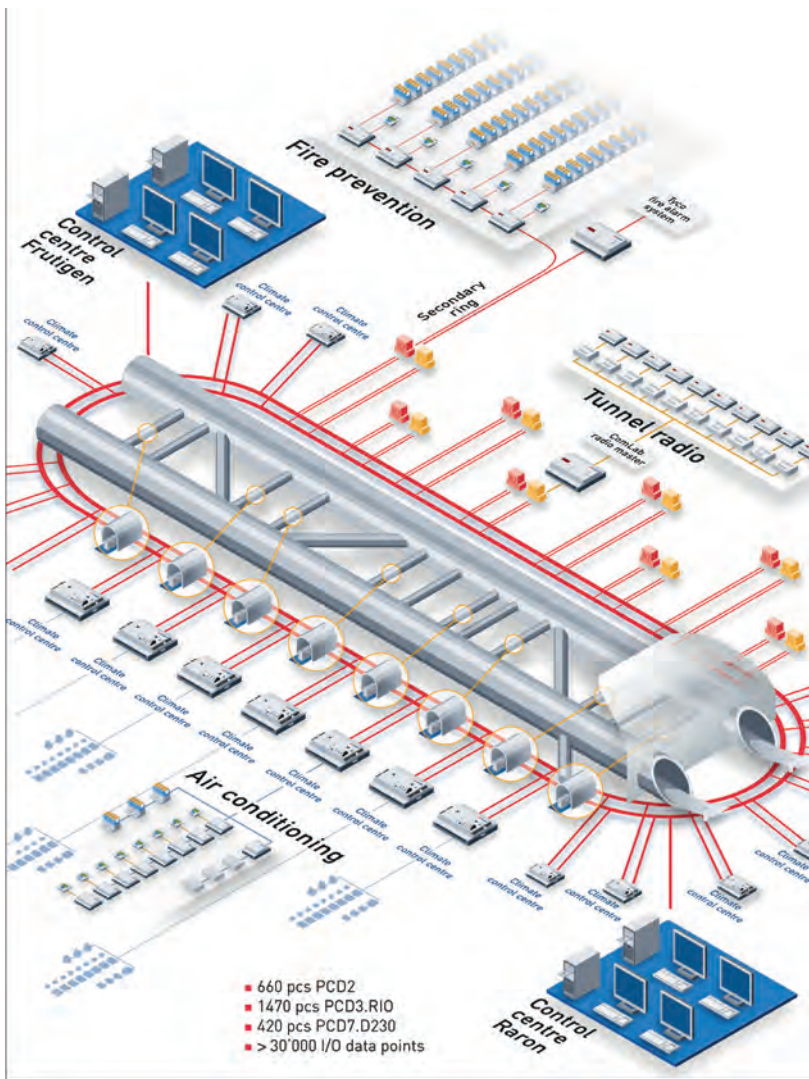

- 660 pcs PCD2
- 1470 pcs PCD3.RIO
- 420 pcs PCD7.D230
- > 30'000 I/O data points

**Overview of installed Saia PCD® in realization phase**

Two single one track tubes:  
 Second tube was broken out to 2/3, missing 1/3 out-break. In 1/3 of the second tube the railway technology is fully installed.



**Operation phase 2007–2010**

The tunnel works but is due to the many different control systems very intensive and expensive in maintenance. Saia PCD® systems are used for air conditioning, radio network and fire protection. Five other control systems from different manufacturers were used to thousands. Most dedicated compact controller, proprietary and not expandable. Connected to control center via gateways and converters. Direct communication between individual sections is completely impossible. Functional impasse – far from being "Lean".

**Operation phase 2007 – 2010**

**Control center Spiez**

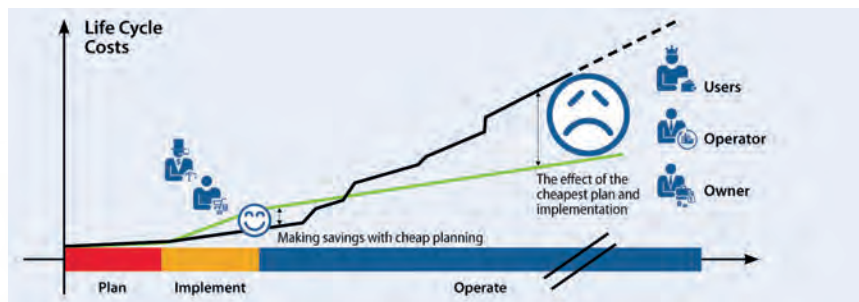

▲ Poor planning and cheap realization always hits others: The operating costs are high. Worry, stress and anger in the maintenance crew.

**1500 control cabinets in 104 cross tubes**

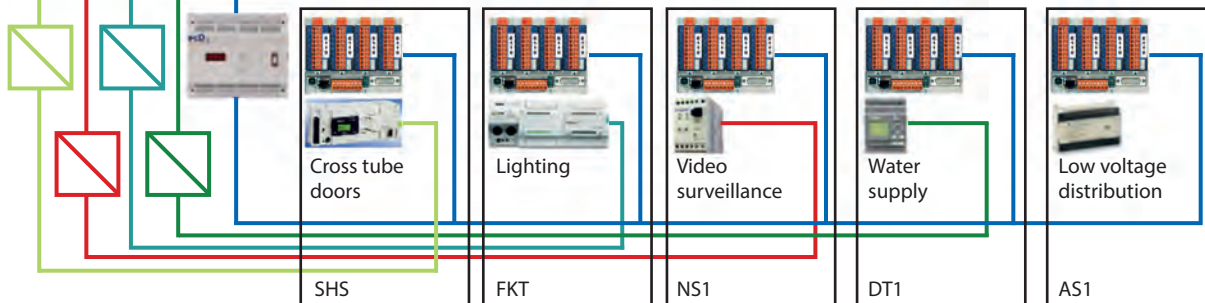



**Biggest problem:**

**Frustrated staff, hardly specialists available**

- After starting operation in 2007, they had 1.000 alarms per day at the control center, peak were 5.000 alarms.
- Enormous stress for the tunnel operators
- Maintenance team was constantly in the tunnel
- Some emergency corrections reduced the number of alarms, in 2009 there were still 30 alarms per day, 1 alarm per hour
- Still 5 interventions with 2 men per day
- Unacceptable!
- Intervention team provides hundreds hours of over-time, spending days and nights in the tunnel. No improvement in view.
- Stress, resignation, frustration
- Quits of company
- Hardly professionals available in the market
- The BLS management is in distress.
- Not the too high CHF 5 million operating costs for intervention are the main concern, but the lack of staff to maintain the tunnel.
- Personal situation became operating risk!

**2010: BLS decides the project „New tunnel management and control system“**

- Targets optimization project:
- Save and reliable tunnel operation
- Reducing of maintenance costs though standardization
- Life Cycle oriented system approach
- Increase efficiency through remote diagnostics
- Less stress and anger in the operation
- A budget of CHF 18 million is spoken for the project

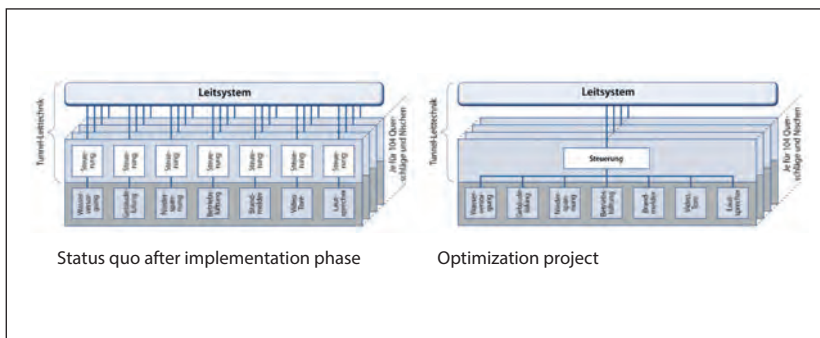

**2010-2012: Correction of errors in construction phase**

- Pooling of communication: One single interface between cross tubes and control center
- Replacement of all compact controllers with modular, expandable systems
- Life cycle approach should be implemented
- „Cheap in Mind“ comes out to reach “Peace of Mind“ for the operator
- For all automation tasks of the technical infrastructure Saia PCD® should be used.

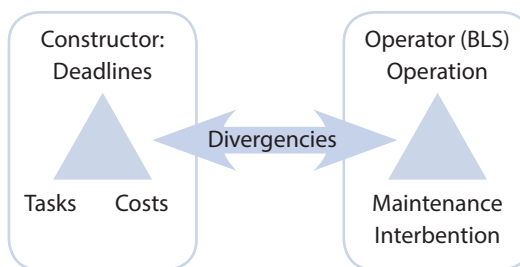

◀ Conflicting interests: problems are predictable

**2010- 2012: Corrections of errors in construction phase**

**Control center Spiez**



▲ Thanks the optimization project the operation achieved now "perfect fit" - over the entire life cycle.

**1500 control cabinets in 104 cross tubes**

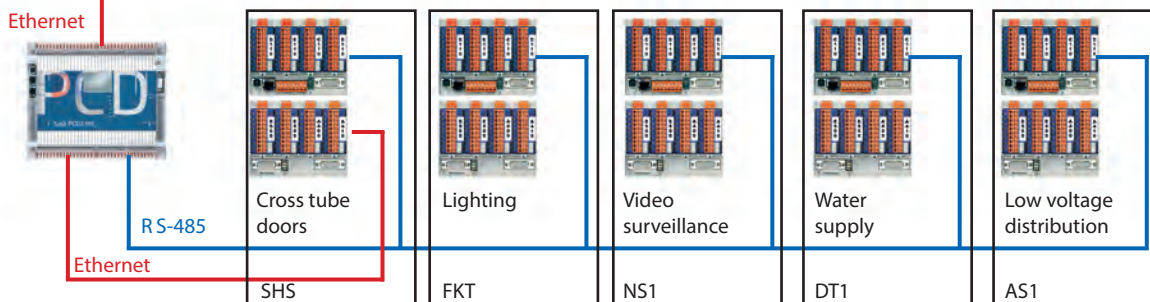

**Lean Automation is also visible:****Cabinets before and after reconstruction**

- ▶ Predestined example of Lean Automation:
  - The modified cabinets are much slimmer than the originals from the construction phase.
  - A lot of hardware became obsolete and have been removed.
  - Thanks to slimmer cabinets the risk of interferences and errors is greatly reduced
- ▶ Transparency replace boundaries and barriers – thanks to industrial PLC technology with integrated standards from the Web and IT world.

Cabinet before conversion ▶

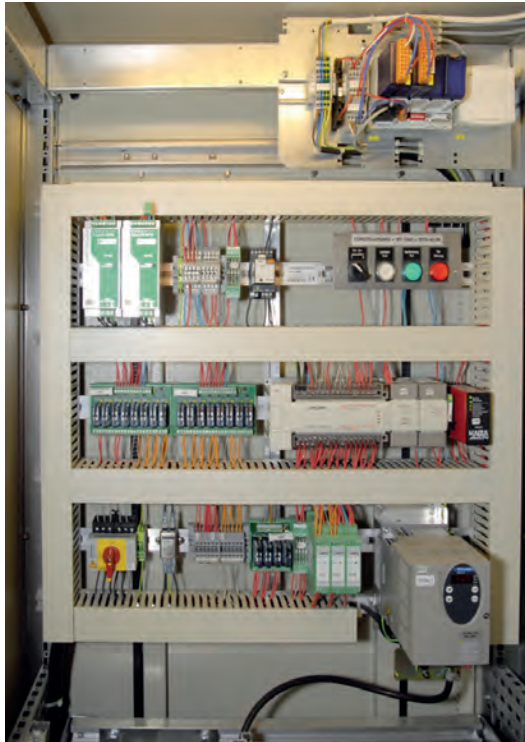
**Why the operator BLS has opted for Saia PCD®?**

Saia PCD® supports open standards of industry, building automation and Web+IT – no boundaries and barriers by proprietary protocols. All interfaces and protocols, actuators and sensors in the existing cabinets can be integrated.

Saia PCD® systems of earlier generations can be replaced easily and without great expense by the latest generation. I/O modules and application software will remain compatible.

With Saia PCD® BLS has the greatest possible independence. In principle each Saia Burgess Controls system integrator can support later modifications or extensions. BLS sees Saia Burgess Controls as a flexible, reliable partner and in the Saia PCD® the automation system which guarantees robustness and innovation providing long product life cycles.

**Overview Saia PCD® material after conversion: 100'000 actuators and sensors are connected to Saia PCD®**

BLS has invested CHF 18 million in the optimization. The proportion of Saia PCD® material is 10%. This small part would be the most benefit for the operator.

BLS wants to amortize the investment in 10 years. The expected savings in operating / intervention costs is CHF 1.8 million per year.

BLS expects around 10 alarms per day and only 1–2 interventions per day.

- In one year the first results for comparison are available.
- All are confident:
  - The management, the tunnel operators, the maintenance team

**Start of operation (2007–2009)**

Resignation and frustration in maintenance team after the start of operation in 2007.

Many real and apparent errors cause many stress. Functional impasse do not allow prospects.



▲ Cabinet after conversion



Optimization project  
„New Management  
and Control System“  
(2010-2012)



**After optimization (2012)**

Peace and calm replace worry and frustration. Consistently reliable and open automation technology supports maintenance crew in best way. Boundaries and barriers have fallen, long life cycle is ensured.

**Systematical minimization of worry, anger, obstacles and boundaries for the operator of technical infrastructures.**

	350 pcs. SBC Automationsystems PCD2.M120/M170/M480
	370 pcs. SBC Automationsystems PCD2.M5540
	250 pcs. SBC Smart Ethernet RIO PCD3.T666
	1500 pcs. SBC RS-485 RIO PCD3.T260
	3500 pcs. diverse Saia PCD2 I/O Modules
	7000 pcs. diverse Saia PCD3 I/O Modules
	450 pcs. SBC HMI PCD7.D230

◀ Final stand after rebuilding in 2012

**Our Partners:**



◀ Operator & Planer  
[www.bls.ch](http://www.bls.ch)

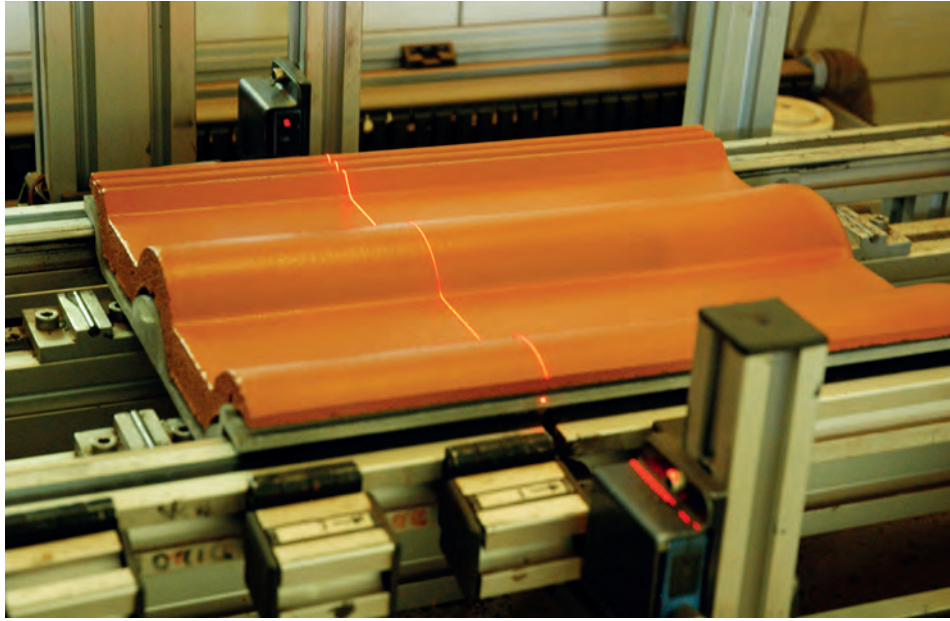

## Update automation in the process industry

**Operator:** Bramac d.o.o.  
**Object:** Factory of roof systems  
**Country:** Slovenia



### About Bramac

Bramac is an Austrian company that uses the international links and the global expertise of parent company Monier for continuous optimisation of its products and sales.

#### ► Facts

- 1966 as "Bramac Dachstein Werke GmbH" was founded
- In many countries of Central, Central Eastern and South Eastern Europe with the major and most innovative providers of the component roof

#### ► Bramac d.o.o. Slovenia

In 1998 cpl. automation of roof production was done with Saia PCD4 systems. The environment is very demanding (moisture, dust). Production capacity is 100 pcs/min »45.000/8 hour.

Factory Bramac ▼



### Requirements and expectations of the update automation

#### ► Target

Owner decided to improve (additional protective layers) the production of roofs titles therefore have to add some additional process components (motors, conveyor, measurement) through collective holiday. They are satisfied with old PCD4 system. No problems with PCD4 I/O modules through live cycle (15 years). By replacement CPU try to involved a new technology (WEB) in a production. Analyse of production (transparency achieving about production).

#### ► Full list of required features

- 3 weeks for all adaptations
- Minimize intervention in cabinets wiring
- Option to add new I/O datas and integration into the existing program
- Add analyse of production (collect data's of production as csv file)
- Use Web technology by visualization (useful for service/ maintenance)

#### ▼ Adapted cabinet



**Implementation**

- To cover all requirements, the system integrator installed the following system components from the manufacturer Saia Burgess Controls:
  - 1x Upgraded PCD4.U100+PCD3.M5540
  - PCD3.R600+PCD7.R-SD1024 (save csv files)
  - PCD3.W210
  - PCD3.W625
  - PCD3.E165
  - PCD3.A465
  - Total = 387 I/O points
  - new 1x PCD1.M2120 (for cutting)
  - new 1x PCD7.D5100 (WinCE 15") (for operator cabinet)
- Cutting was done with new PCD1 (before with classic timers)
  - Request for 5 ms timer resolution → made with IL and interrupt
  - Old application was done with IL, HMI panel with Graftec – complex to understand and reconstruct (need support from SBC Murten)
  - Total = 32 frequency. convert
  - 73 motors, tot. power supply: 110 kW

**Benefits/Challenge**

- Restart of production without delay (without loss money)
- Fully functionality and transparent with old application (no problems for operators)
- Replacement has involved modern WEB HMI design
- Upgrade kit complete/solution was much cheaper as complete replacement with others controllers (e.g. Siemens, Beckhoff)
- Allow further replacement PCD4 I/O modules with PCD3 I/O modules (whole cabinet with PCD3 components)
- This pilot project in Bramac could bring in future similar projects in others factories (other countries) – general decision



▲ before



▲ after

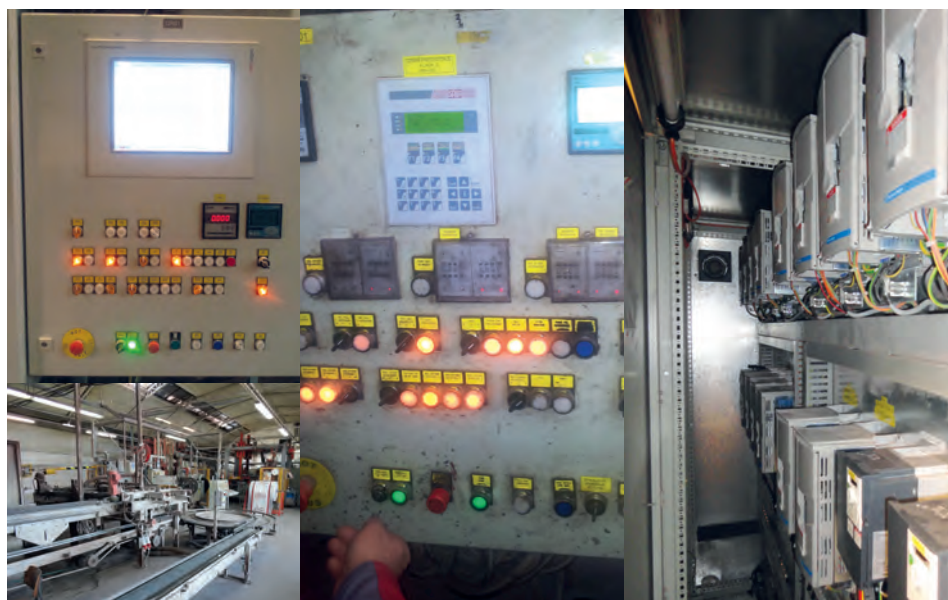
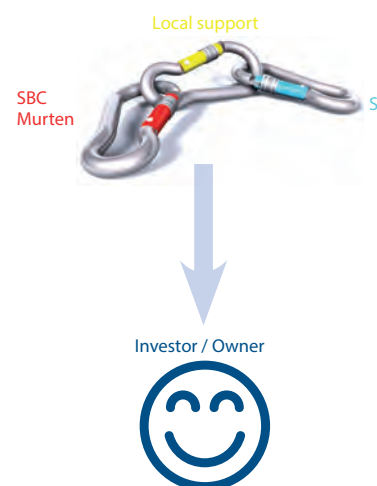

◀ New operator cabinet, Productionline, Old operator cabinet, Powersection

**Our Partners:**

 ◀ Operator [www.bramac.at](http://www.bramac.at)

 ◀ Planer & Systemintegrator [www.avtoma.si](http://www.avtoma.si)



## Swisscom Hospitality's Smart Room Controls @ citizenM London Bankside

Operator: citizenM  
 Object: Hotel  
 Country: The Netherlands



### Swisscom Hospitality Services

- 300+ employees worldwide fully dedicated to Hospitality
- Operations across Europe, Africa, Middle East and North America
- 2.300 hotels - 250.000 guest rooms
- 5 mio. square feet of meeting space

### Tasks and Objectives for the global hotel rollout

- Requirements room control:
  - Flexible, standardised and fully integrated into IT network
  - Easy to install and commission by non PLC specialists
  - Manage through the hotel lifetime
- Saia Burgess Controls as partner and Saia PCD1 with interfaces to integrate:
  - Climate Control
  - Hotel Room Access Control - reader and lock RFID
  - Room Switches
  - LED Lighting & Blind/curtain control
  - Guest handheld device (Android-Samsung TAB with modification)
  - Wireless Access Point
  - Remote Network Monitoring (Ethernet)
  - Connected TV and other services such as wake up and room status
  - Cloud based Hotel Property Management System

Room controller PCD1 ►



◀ Roomcontrol as managed service over IP-network

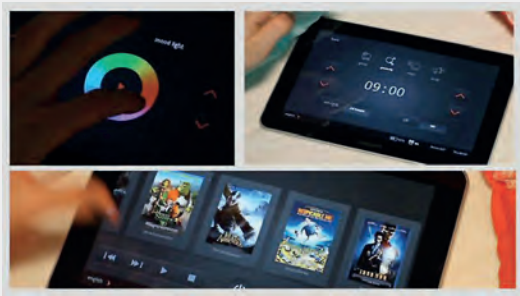

**Demands for:**

- Preconfigured room profiles
- Remote activation at arrival
- Energy saving modes after leave
- Individual guest satisfaction





citizenM hotels ▲

### Headquarter based in Voorschoten Netherlands

#### The Netherlands

- Amsterdam airport \*
- Amsterdam city \*
- Rotterdam

#### United States

- New York Times Square
- New York Bowery \*

#### United Kingdom

- Glasgow
- London Bankside
- Tower of London \*
- London St. Paul's \*

#### France

- Paris Charles de Gaulle Airport \*

\* these hotels are planned or under construction



company info  
mission  
team  
partners

to create a luxury contemporary hotel  
for the cost conscious traveler  
**affordable luxury for the people**

### Use of the PCD system

- Each guest room will be equipped with one roombox for autonomous operation
- Guest functions driven by a Swisscom moodpad
- Interfaces to any 3rd party HVAC systems
- A 24 VDC roombox will be able to be implemented at any of the planned hotels worldwide
- Standardised Installation and Commissioning
- Configured for DHCP or manually set IP address
- PCD1 management and alarms will be transmitted to the Swisscom's global Network Operations Centre (SNMP protocol)
- Remote configuration of application program
- ▶ Plug and Play supply of a CitizenM roombox:
  - Enclosed roombox, metal, easy to manage around the world
  - Low voltage solution
  - Internal cabling, connectors
  - Consisting of PCD1 and LED driver

### Project scope citizenM

- ▶ Hotels under construction; total 1913 rooms (for each room a roombox and PCD1.M2120ZAV)
- ▶ Pilot project Swisscom SHS, citizenM, Saia Burgess Controls: London Bankside: 192 rooms
- ▶ Projects under construction:
  - London Tower Hill: 370 rooms
  - London Cape: 240 rooms
  - New York Times Square: 240 rooms
  - New York Bowery: 300 rooms
  - Rotterdam Blaak: 151 rooms
  - Paris Roissy: 220 rooms
  - Paris La Defense: 200 rooms
  - Glasgow: 198 rooms (replacement Philips/Beckhoff)

### Working with Swisscom Hospitality clients

Through selected skill set partnership with Saia Burgess Controls Swisscom Hospitality can extend the reach of the hotel LAN and support hotels via regional hosting centers. In this way, hoteliers benefit from leaner IT infrastructures on-site, integration and the cost advantages of on-demand computing. citizenM offers the customers a service that is standardized around the world. Use of technology is pervasive in their hotel design to maintain low operating costs and provide advanced digital services to the guest. Working in a corporate relation on an international level. Saia Burgess Controls is delighted to be able to work with highly demanding and critical partners to achieve a variety of aims.



▲ Saia PCD<sup>®</sup> layout in Cabinet #1

**You Tube**

▲  
Another World  
is possible series  
Shot at citizenM London  
Bankside



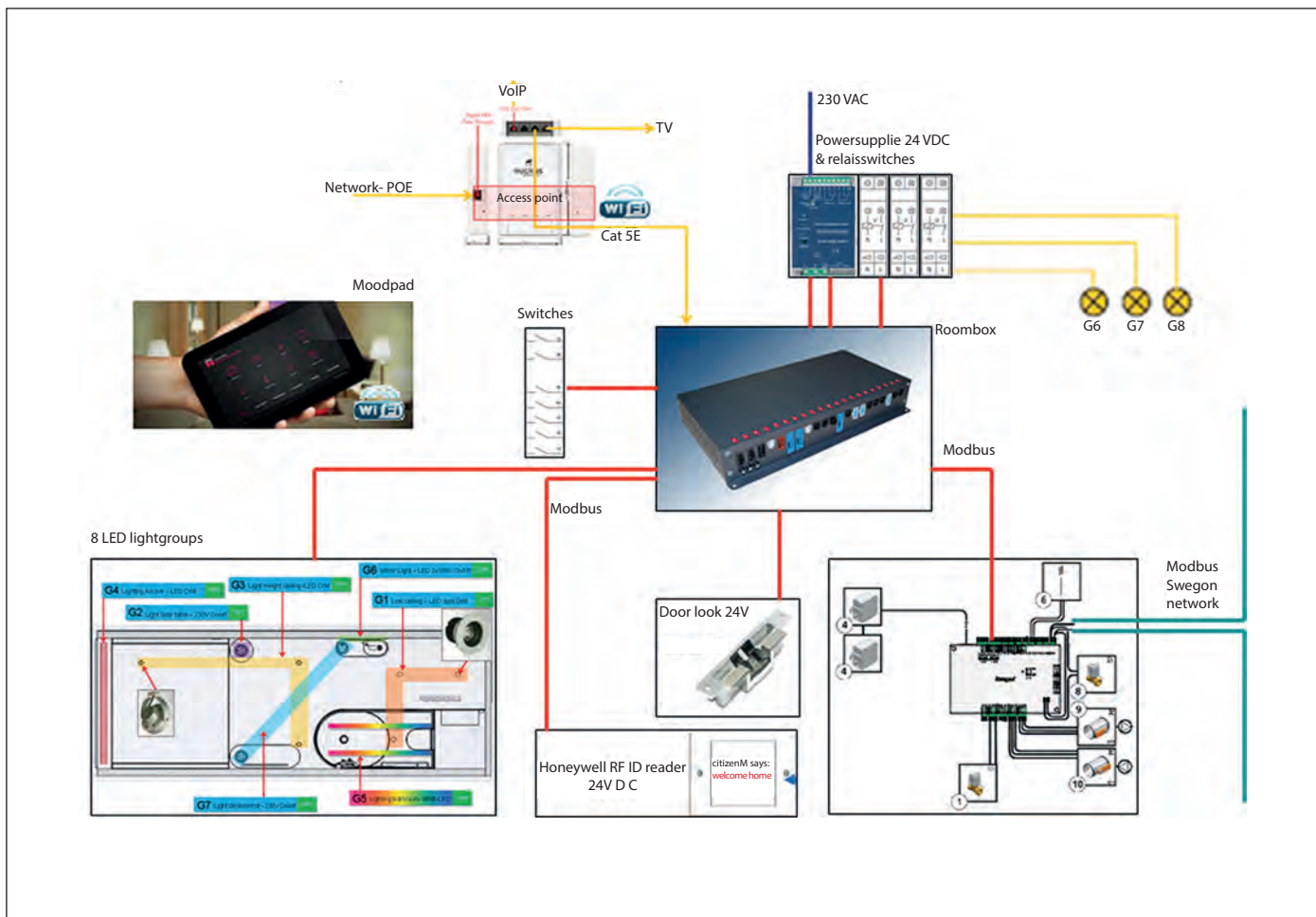

▲ IT overview citizenM hotels

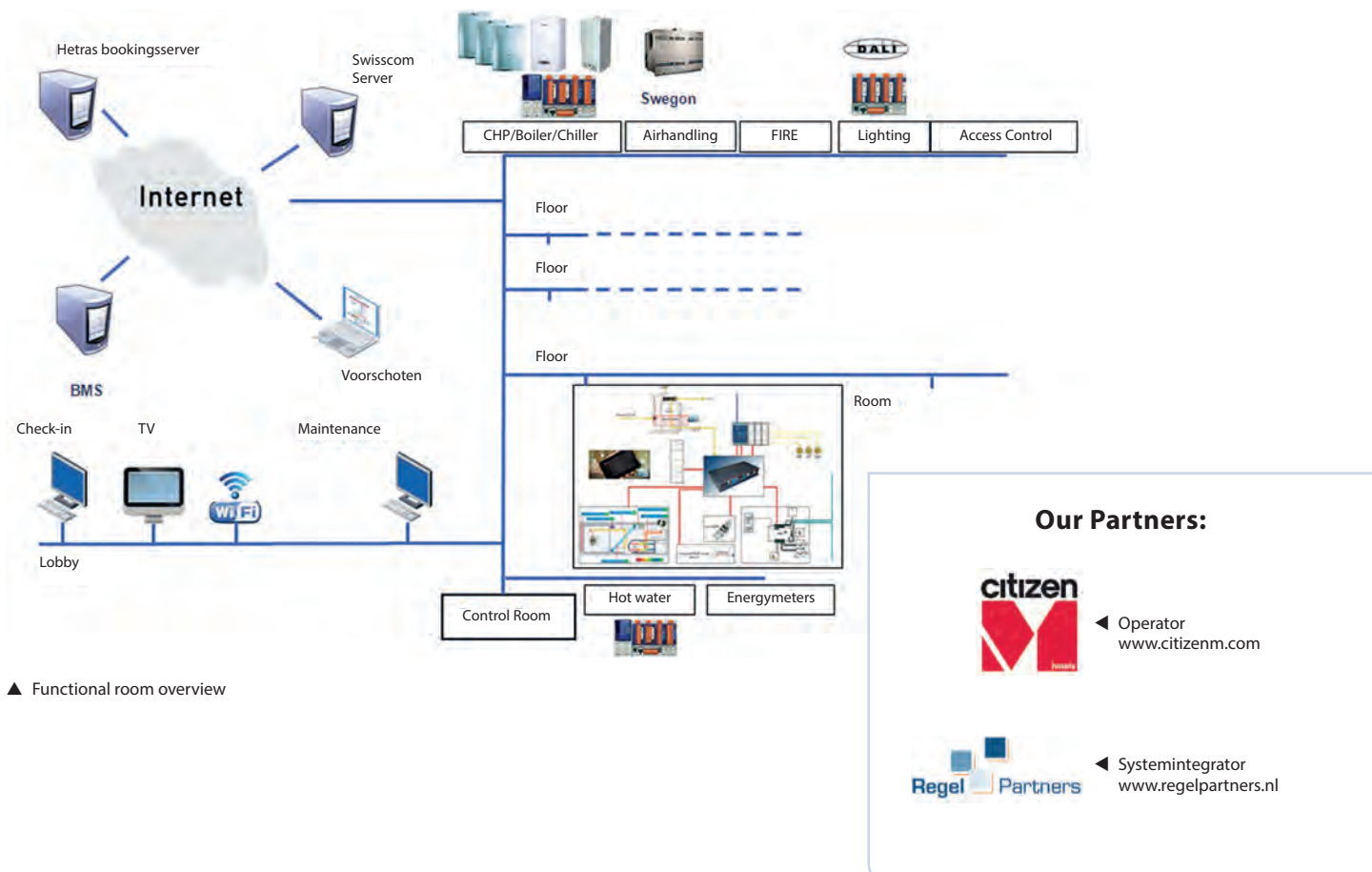

▲ Functional room overview

## Energy solution in student housing

Operator: Crous of Clermont Ferrand  
 Object: Housing  
 Country: France



### CROUS of Clermont Ferrand

CROUS manages housing for 3798 students and over 3 sites:

- The city center of Clermont Ferrand
  - The campus Cézeaux Aubiere Residence Montlucon
- 2315 student housing are managed by the CROUS in 5 homes on Clermont Ferrand and Montlucon Aubière.

### Objectives of the project

- Integrate the management of electrical energy in one of the three renovated towers
- Monitor and visualize the consumption of each student room and building from a PC without special software
- Able to store the data from all the counters over 2 years and export them to Excel
- Identify excess and decide early intervention to resolve the problem
- Plug & Play use of Energy Manager in the first instance.
- Offer a simple solution which is expandable due to the alert and consumption analysis

### The summary

- A positive balance!
  - CROUS can simply view and monitor the consumption of the whole building
  - No engineering was necessary to respect Plug & Play solution
  - Grip easy local or remote solution by the Energy Manager CROUS

### The future!

- Evolution of the system with the Saia PCD® technologies
- Alert by email when exceeding the threshold set by the CROUS
- Data Analysis with Excel to better determine the new threshold subscription

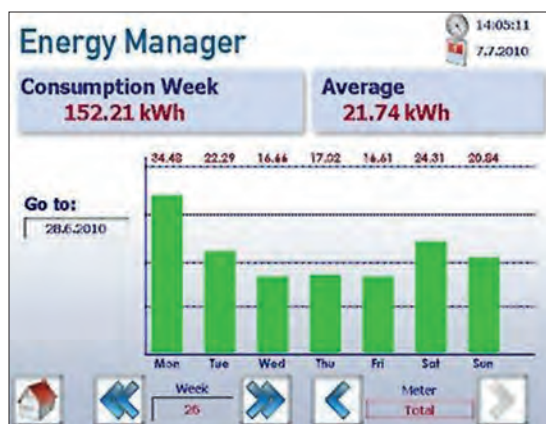

▲ Residence street Philippe Lebon Clermont Ferrand, 3 towers with 478 students housing

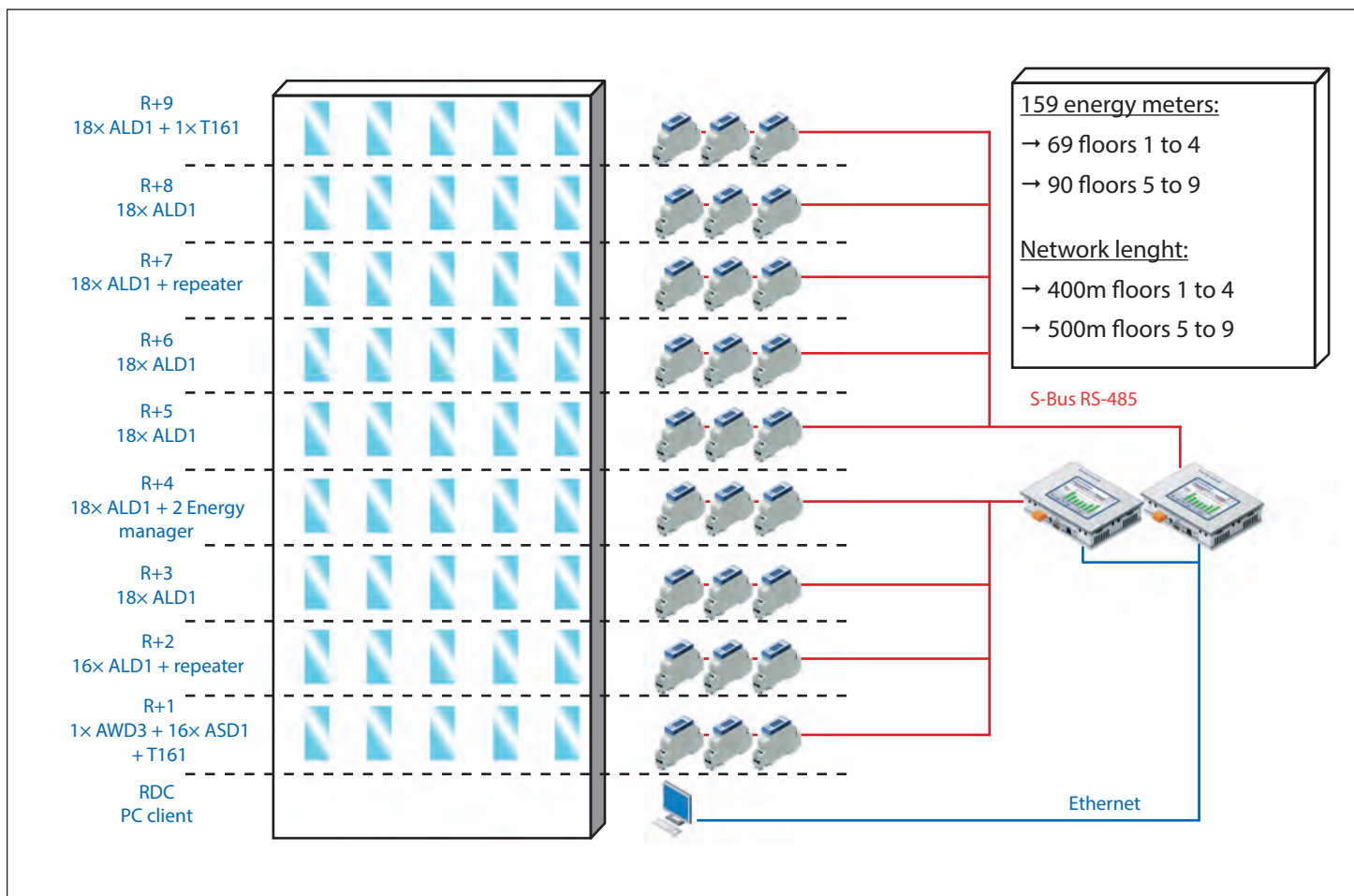

**Our Partners:**



◀ Operator  
www.crous-clermont.fr



◀ Systemintegrator  
www.suptech.eu

◀ PCD1

## Building construction a brezillion's head office



**Operator:** Brézillon  
**Object:** Building  
**Country:** France



### About Brézillon

Brézillon, subsidiary of Bouygues Construction. Leading construction company in the region of Ile-de-France in the collective building construction. Brézillon built his headquarter.

Future building of 2000 m<sup>2</sup>. The objective is to achieve ambitious consumption of 63 kWh/m<sup>2</sup>.

- 2000 m<sup>2</sup> of offices
- Margny-lès-Compiègne

### Ambitious objective

For the construction of their new headquarters, Brézillon wishes to construct in point of view of energy consumption a reference building.

► To achieve its objectives

Supervisor	› Communication BACnet
Air conditioning Daikin	› Communication BACnet
Water Meter	› Communication M-Bus
Heat Pump	› Communication BACnet
Room controllers	› Communication S-Bus
Room thermostat	› Communication EnOcéan
Energy meter SBC	› Communication S-Bus
Energy meter Legrand	› Communication Modbus
Energy Optimizer	› Communication Modbus

► Saia Burgess Controls systems were able to concentrate all heterogeneous systems through standard protocols.



▲ PCD3.M5340 + PCD7.R560

### Implementation to reach the goals

An architecture based on a modular expandable PLC to facilitate maintenance.

Extensible and scalable, it is always possible to make changes to meet new needs.

### Architecture Saia Burgess Controls contain:

- 4× PCD3.M5340 (PLC for floors)  
+ PCD7.R561 (BACnet card)
- 1× PCD3.M5340 (PLC Heating)  
+ PCD7.R561 (BACnet card)
- 91× PCD7.L651 (EnOcéan Radio receiver)
- 297× PCD7.L600 (rooms controllers)
- 65× ALE3 (three-phase counters maxi 65 A)
- 16× ALD1 (single-phase counters maxi 32 A)

The implemented solution controls more than 2400 points I/O dedicated to the electrical and heating.

### Perpetual evolution

► Touch Panel

Access to Web imaging in cabinets techniques, allows the Brézillon's planer to manage comfort improving in their accommodations.

► Additional work

Systems SBC has adapted to the new demands of the project owner. The addition of a system for energy optimization. Thanks to the flexibility of the API, it was possible to host the communication module in the existing architecture with no additional cost.

► Energetics diagnostic

At the request of Brézillon for monitoring consumption, CR SYSTEM designed a grouping interface for the key indicators.

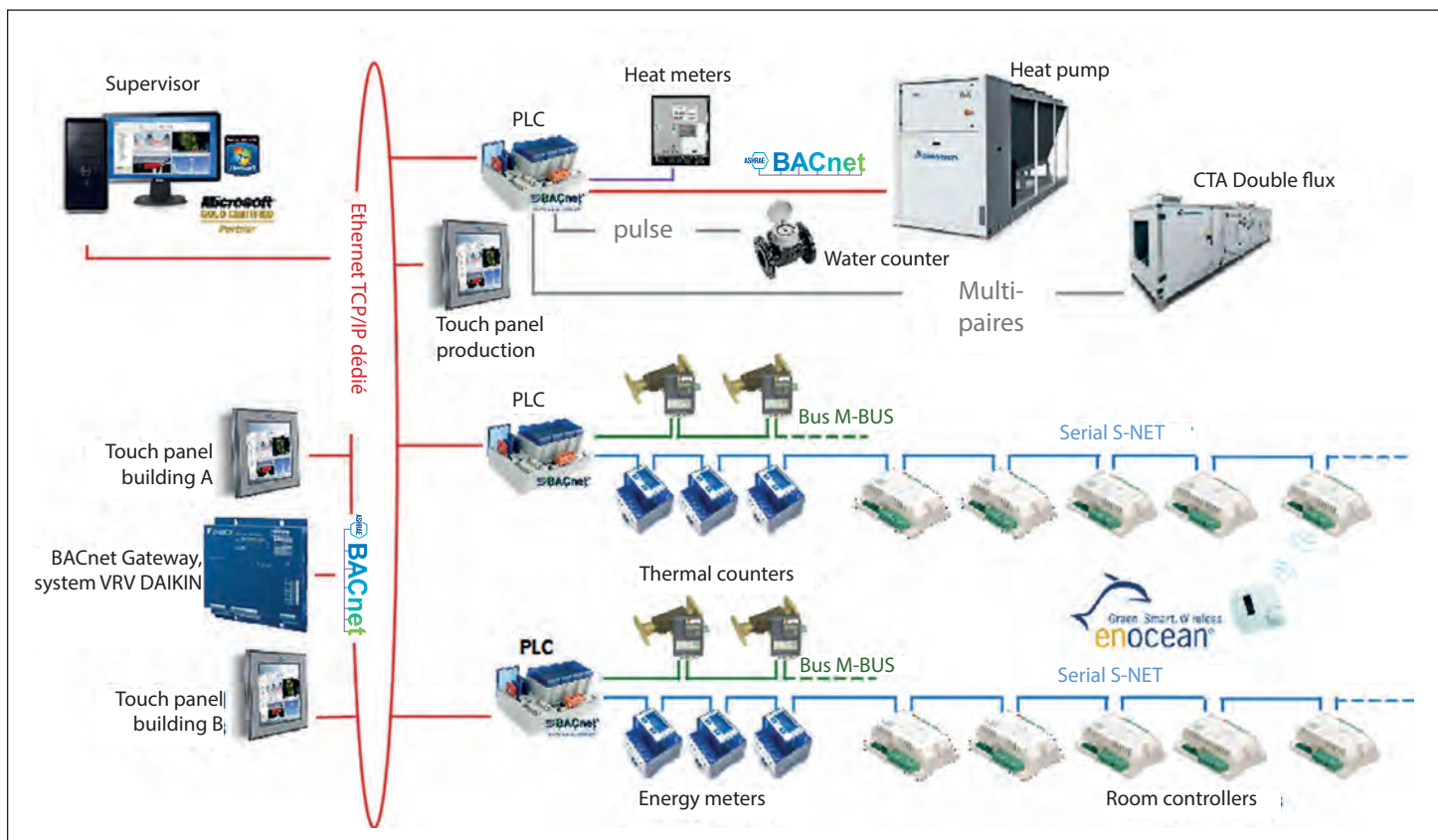

▲ Bus Topology



▲ Supervisor



▲ PCD3.M5340 / PCD3.M5340

**Our Partners:**

**Brézillon** ← Operator  
www.brezillon.fr

**CR SYSTEM** ← System integrator  
www.crsystem.fr



## Securing the supply and distribution of drinking water

**Operator:** Dunea  
**Object:** Pumpingstation  
**Country:** The Netherlands



### DUNEA - Dune & water

- Dunea supplies reliable water utilities for approximately 1.2 million customers in the area in and around The Hague
- Dunea manages the dunes between Monster and Katwijk and preserves the collection of drinking water
- To be able to comply to the 24/7 demand of drinking water, also for future needs, it is necessary to adjust the production capacity
- The project 2PGS: 2 PompGebouwen (pumping stations) Scheveningen, was conceptualised to meet this demand
- The pumping stations take care of the drinking water distribution to its users.

### Tasks and Objectives

A part of 2PGS regards the construction of 2 new clean water pumping stations, including:

- 4 connections to the current piping and conduits
- 8 new, clean water pumps
- 4 new generator sets by Van Wingen

The pumps of that time needed to be replaced. The security of supply norms within the new drinking water regulation, also made it necessary to divide the pumping capacity between two separate buildings, in order to run these independently.

The emergency energy supplies are part of the full energy control at this site. The 4 generator sets are installed in two separate pumping stations. The gen-sets are equipped with big Perkins engines, type 4012 and supply 1475 kVA each.

### Implementation

- Redundant network of 6 PCD2 devices, 4 Web Panels 10,4" and 2 Web Panels 15"
- SI Van Wingen has been using Saia PCD® for more than 25 years now, based on trust, quality, support and a good relationship
- Van Wingen has its own engineering department where the Saia PCD® application software is being maintained and customized, depending on project demands. The hardware engineering department designs the control cabinets in-house

### Use of Saia PCD® System

- Control of generator sets and energy system
- Gen-sets 4x PCD2.M5540
- Pumping station 2x PCD2.M5540
- Communication between PLCs: Ethernet
- Communication field and energy monitors: Profibus
- Multi-master network: redundancy
- Engineering: PG5 and Web Editor Advanced



▲  
Dunea complex

- HMI based on Saia Burgess Controls S-Web concept
- PCD2 integrated web server, web project stored on 4MB flashcard
- Ethernet communication between the PCD2s and Web panels
- Web panels (fanless touch screens) used in project
- 4x PCD7.D5100TL 10,4" Windows CE
- 2x PCD7.D6150TL 15" Windows eXP
- Data logging
- Excel compatible csv-format, generated and stored in PCD2s
- 1000 events are also buffered in panels, accessible via USB e.g. in case of network failure

**Benefit / Testimonial**

- Web+IT standards for easy remote access
- Onboard web server for remote monitoring and service
- User interface Web-HMI
- Communication; control network separated from supervisory/management

- Multi-master: redundancy
- Multi-protocol
- Fast response and high cycle time
- Data logging, file system
- Process and alarm logging data in PLC; 1000 events are also buffered in Web panel
- Modern, flexible system

“We’ve been using Saia Burgess Controls systems for over 25 years, because of the reliability of their control systems.”

Mario Mattheeuws  
Project manager at Van Wingen

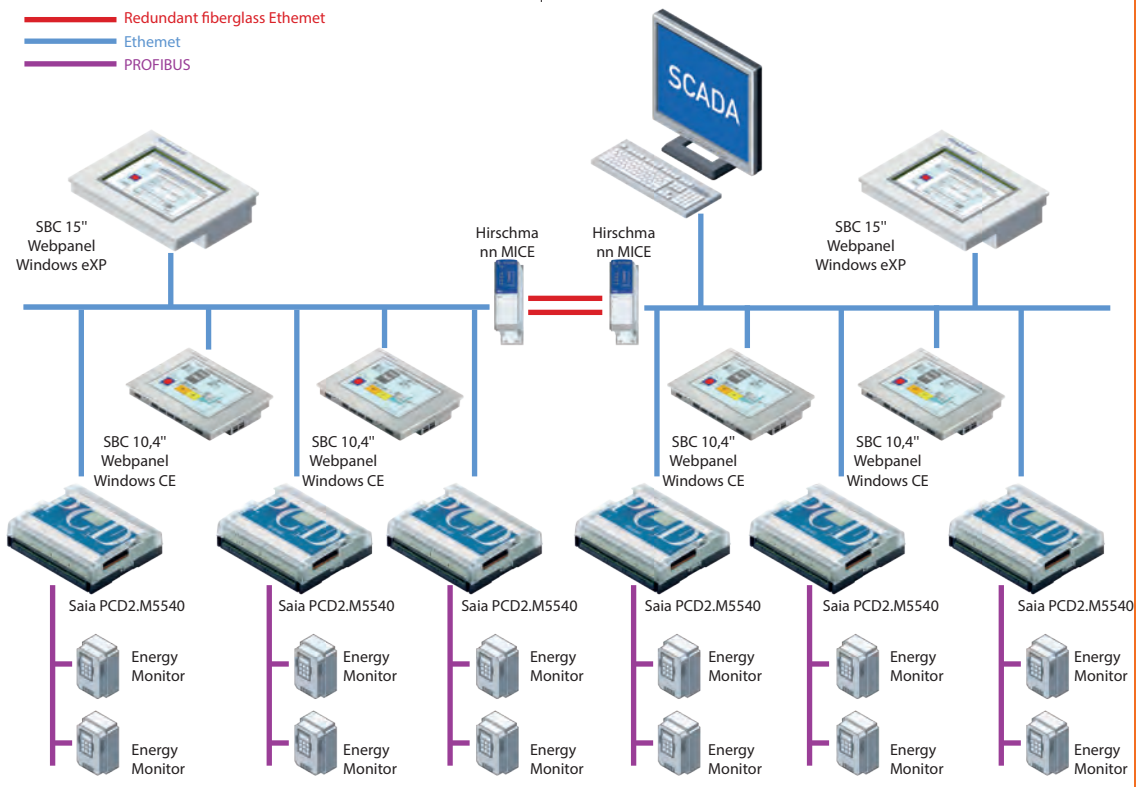

◀ Use of Saia PCD® System (Topology)

“SBC products are: modern, flexible, easy to program. PCD2 functions as multimaster via Ethernet, and talks Profibus so that different types of products like ABB and Camille Bauer can be connected without any problems.”

Stefaan Cauwels  
Project manager at Van Wingen

**Our Partners:**

 ◀ Operator  
www.dunea.nl

 ◀ Planer & Systemintegrator  
www.vanwingen.be



## High demanding application for HVACSE of SPA, fitness & swimming pool, conference rooms and reception/hall

Operator: Grand Hotel Del Mare Bordighera (IM)  
 Object: Hotel  
 Country: Italy



### End-Customer: Grand Hotel del Mare\*\*\*\*\*

- ▶ Grand Hotel del Mare\*\*\*\*\* Bordighera (Liguria)
  - Prestigious structure in exclusive location
  - Hotel/museum with worth pictures and furniture of '700-'800
  - Same owner of Museum Villa Regina Margherita in Bordighera

### Task: Achieve 5-stars standards in all services

- Scope of the project: Renovation of common areas
- Innovative, based on "state of the art" technologies:
  - LED lights with dimming and RGB color/T° regulation
  - Integrated scenarios: lights, curtains, beamer/audio, HVAC
  - Wireless control (iPads), "easy to use" for operators/guests
  - Web-based remote control for diagnostic/service
  - Efficiency: air quality sensors and modulating air handling units
- 4 steps in 4 years: SPA/fitness, hall & reception, mezzanine, conference rooms & swimming pool & kitchens (HVAC)



**Implementation: 12x automation cabinets equipped with Saia PCD3 systems;  
750x DALI-channels Project requirements, „New 11/12“**

# Saia PCD®



- 12x PCD3.M5340 with Webserver and local Micro-Browser
- 1.000 HW I/Os
- Control of 3 Air Handling Units
- Saia Burgess Controls Web + WiFi + iPads for remote control of scenarios/functions
- 750x DALI-channels via 15x PCD3.F261
- 200x not-dimmed spots via std. I/Os



- Ethernet TCP/IP backbone
- 20x Modbus TCP nodes: motor drives, automatic main circuit-breakers

- SCADA Movicon by Progea (at reception)
- Local SBC Micro-browser for diagnostic & set-up
- Internet remote access for diagnostic & maintenance

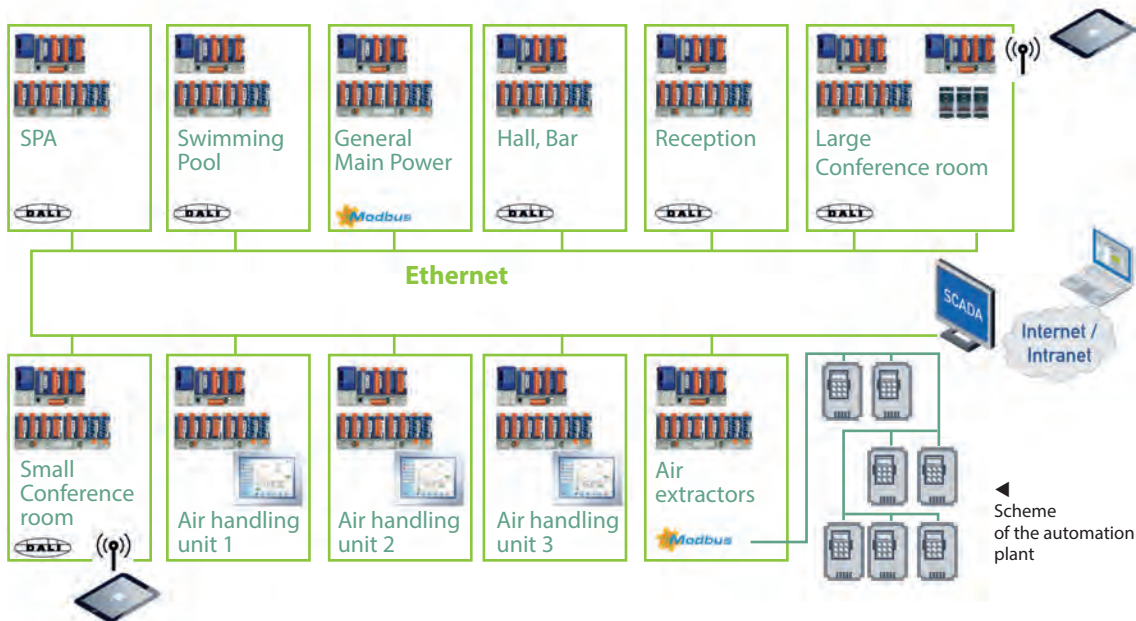

### The User – The Systemintegrator: Their opinions

- Benefits for the end-customer
  - Comfortable and innovative solutions to satisfy the highest standard
  - Flexible and user friendly to be adapted to any need in an easy and fast way
  - Efficient: -10m<sup>3</sup>/month of gas (-10%) even with the added conference rooms; -40% electrical consumption
- Why did we choose Saia Burgess Controls?
  - No limits: with Saia PCD® “we could start from scratch without any limit to our ideas”
  - Communication: max. flexibility and protocols
  - Web-server for local/remote operation&service
  - DALI integrated with many channelsx CPU

- Free programmable Saia PCD® allow to implement regulations/strategies to fulfill the highest std. for energy efficiency (EN15232 class A).
- Technical support of SBC reliable to be confident to use new technologies/features

### Our Partners:



◀ Operator  
[www.grandhoteldelmare.it](http://www.grandhoteldelmare.it)

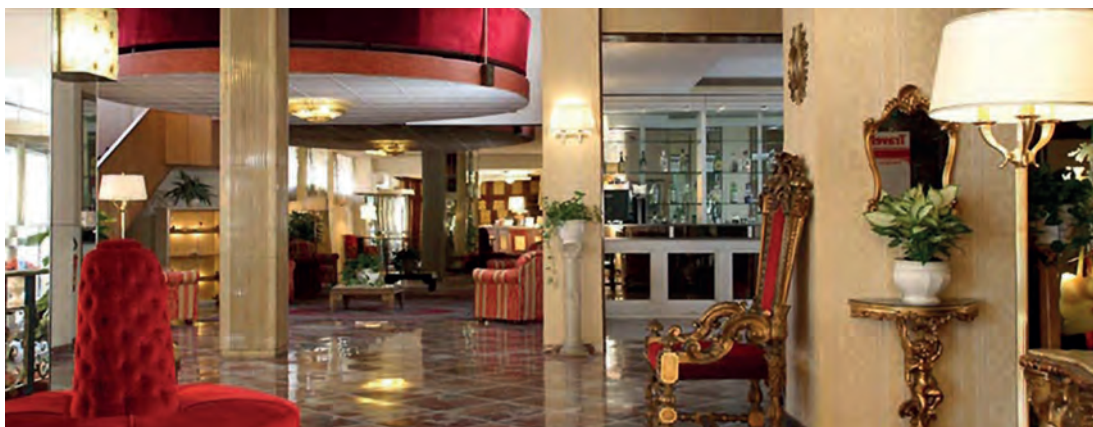

## Air conditioning plant renovation in a 4-stars hotel

**Operator:** Grand Hotel Hermitage  
**Object:** Hotel  
**Country:** Italy



### Grand Hotel Hermitage – Roma Parioli

Hotel Hermitage is the most representative hotel of Leonardi Hotel Group, it is located in the prestigious Parioli district in the centre of Rome.

Hotel Hermitage recently renovated the air conditioning plant for the guest rooms and the public areas (about 100 guest rooms).

### Tasks and Objectives

- ▶ System Integrator: Progei Global Solution Frascati (Roma):
  - > 15 years as qualified Saia PCD® SI
  - Building Automation & Infrastructure applications
- ▶ The application:
  - Air conditioning control in about 100 guest rooms and in the public areas, visualization of temperature and guest presence, enabling of the air conditioning from a station at the reception desk
  - Automatic control of 4 chillers
  - Web-based HMI: no dedicated control/monitoring software
  - Very low budget available
  - Challenge: Saia Burgess Controls was an unknown brand by the end user

### Implementation

The air conditioning system controlled by 1× PCD1. M2120 enabling 4 chillers depending on the needs, + 125× PCD7.L600 + PCD7.L642 room controllers PCD1 CPU with 3× RS-485 networks for room controllers. Dedicated IL program for very efficient data transmission between PCD1 and L600s

The receptionist selects a room: The web-page of related room controller comes in foreground: It allows the fastest access to the controller.

The guest can freely define room settings at the room control: temperature, fan speed, presence; these parameters can be seen and easily overwritten from the reception desk.

The PCD1 CPU hosts the web application accessible from the PC at the reception desk. From her workplace, the receptionist can enable / disable the air conditioning in each guest room, as well as the temperature setpoint.

### Benefits for the end-customer

- Use of the existing Ethernet network
- No proprietary software installed, no license fee
- Expandability of the installed system
- Cost effective installation
- Very fast access to room controllers

Saia Burgess Controls hardware has been adopted thanks to PCD features, that perfectly match the end-user needs, and to the confidence in Saia Burgess Controls by the system integrator.

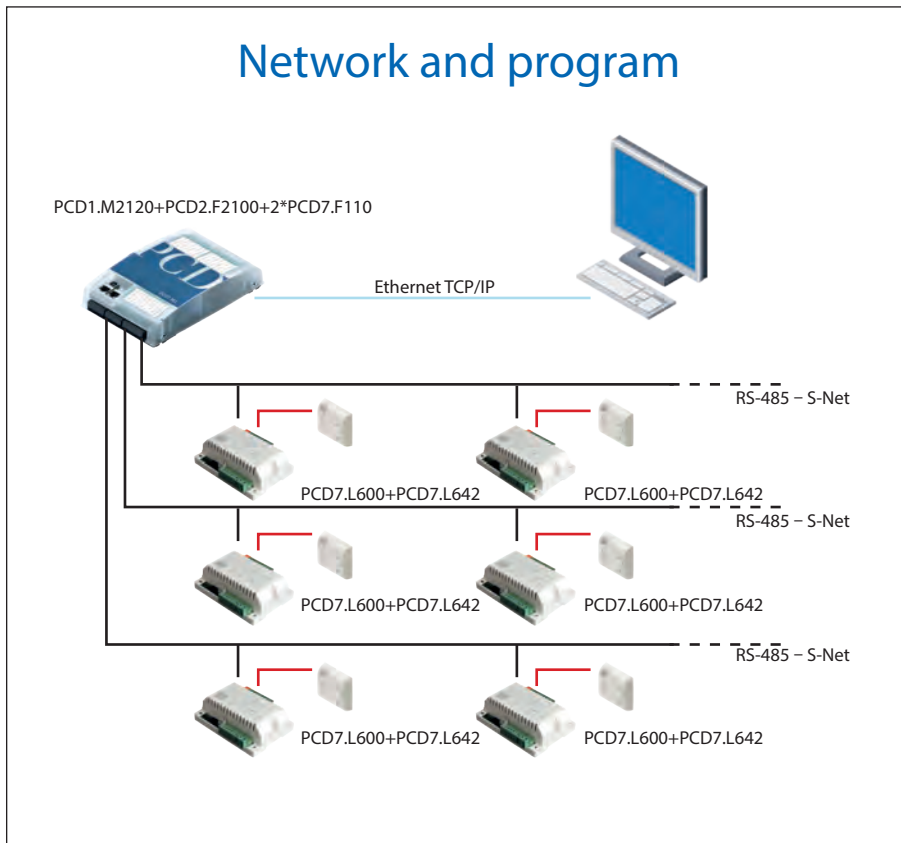

▲ Network and program



#### Our Partners:



◀ Operator  
[www.grandhotelhermitageroma.it](http://www.grandhotelhermitageroma.it)



◀ Planer & Systemintegrator  
[www.progei.com](http://www.progei.com)



## Reference district heating Groupe E SA

Operator: Groupe E SA  
 Object: District heating  
 Country: Switzerland



### Installations of district heating in regions of Fribourg, Vaud and Neuchâtel

The Groupe E SA, No1 supplier of electricity in french speaking part of Switzerland, serves a population of more than 460,000 people in the cantons of Fribourg, Neuchâtel, Vaud and Bern. The contracting division offers studies, realization and operation of district heating facilities. The heat network supply more than 413 sub-stations at 21 sites spread across the cantons of Fribourg, Vaud and Neuchâtel.

### Saia PCD® systems are used for the acquisition of energy consumption for billing

Saia PCD® performs the control of the CAD sub-stations, ensure accurate recording of heat consumption and transmission of the values through the Web and IT network.

NG server regroupe all sub-stations and centre stations, generate the sending of alarms via SMS or E-Mail. All information is managed in a SQL database for analysis, optimization and billing. Specification of the building 10-floors building.

### Implementations and characteristics

Example of district heating networks:

- FRICAD
  - Location: Hauterive, Villars-sur-Glâne, Fribourg
  - District heating network 10 km long
  - Capacity: 22 MW from the central waste incineration / SAIDF Posieux
  - 25 substations including Canton Hospital and the companies Cremo SA, Richemont International SA, Vifor SA and the Villars Verde district (15 buildings)...
- CAD Haut-Lac
  - Location: Roche et Villeneuve
  - District heating network 10 km long
  - Capacity: 3.2 MW by 2 wood heating plants
    - + 4MW gas
    - + approx 1MW CHP (combined heat and power station)
  - 71x substations (forecast 2015: 180 additional substations including the future Riviera-Chablais hospital)

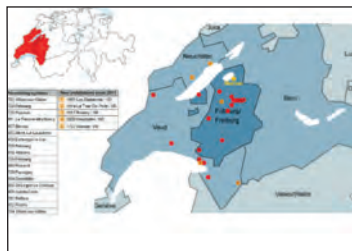

▲ > 250 PCD in use on 21 sites and connected on NG-Server

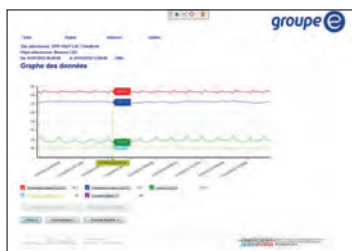

▲ NG server for graph data

**A new zone of 100 villas in Roche with substations PCD1.M2120**

► PCD1.M2120

Manages the following facilities:

- Primary installation for Production Groupe E SA, M-Bus energy meters, control of secondary temperature belong customer needs
- Secondary installation for customer using group heating, hot water, ventilation, remote management

**Benefit**

The Groupe E SA benefits of following advantages by using Saia PCD® for their CAD district heating projects:

- PCD- flexible, efficient and powerful
- Easy monitoring for operator
- Adaptability according to the requirements of customers and facilities
- Open communications to other control systems (Modbus, M-Bus...)
- Reliable automation of energy records via the NG-Server
- Remote access for the integrator and service technicians via the Internet and fiber optic network for monitoring and optimizing

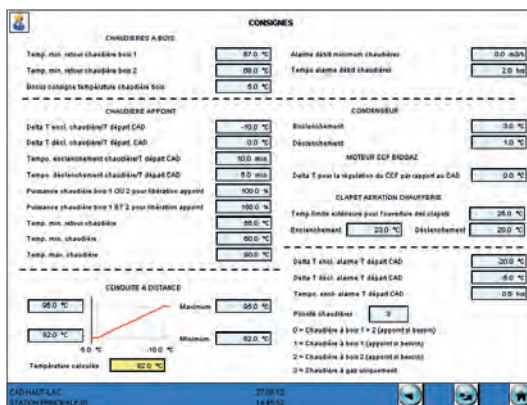

▲ Instructions on the web panel



▲ power plant CAD Haut-Lac



▲ PCD1.M2120+ M-Bus



▲ Distribution cabinet + MCR

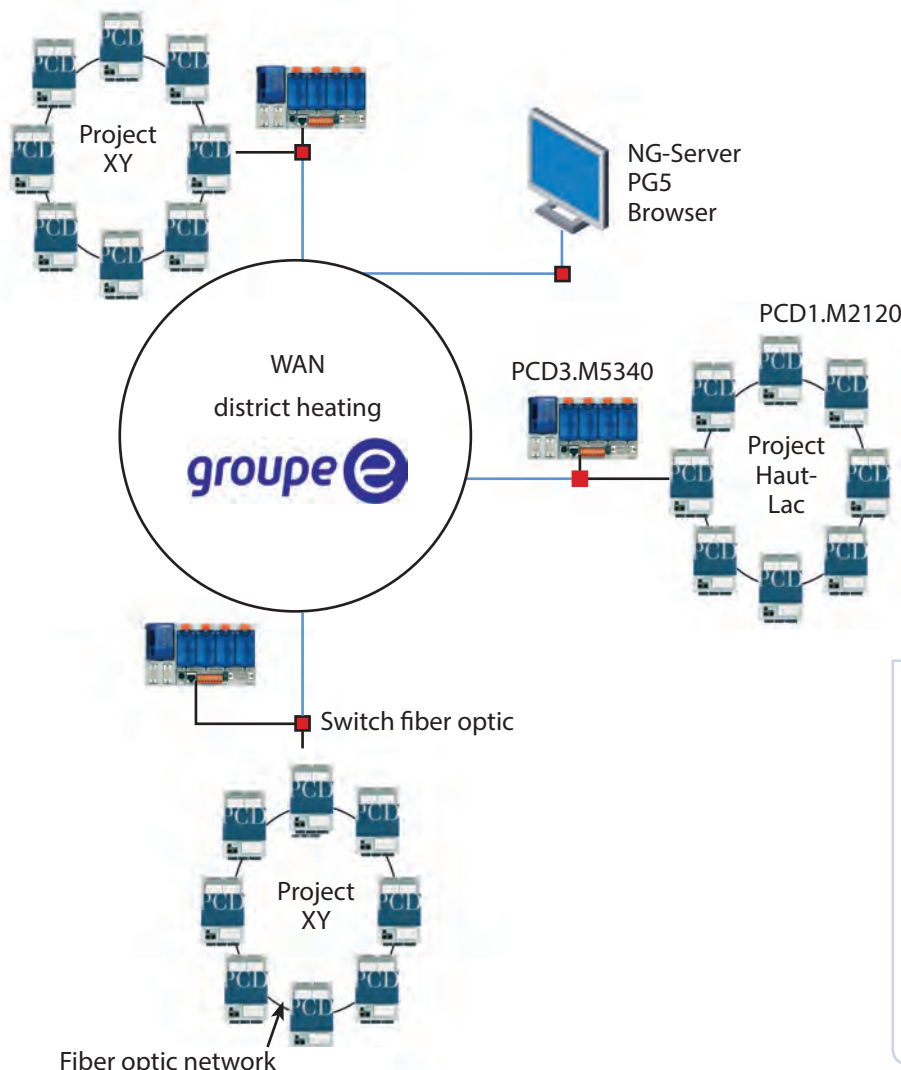

**Our Partners:**

**groupe e** ◀ Operator  
www.groupe-e.ch

**ENERGEST** ◀ Planer & Systemintegrator  
www.energest.ch

# Renewing the Depuration Plant of the city of Cesena

Operator: IDEA  
 Object: Water sewage plant  
 Country: Italy



## Tasks and Objectives

### Customer Requirements

- Industrial grade safe and reliable system
- Backup between two CPUs
- Full Ethernet topology with multiple & parallel protocols:
- Ether-S-Bus + ModbusIP + WEB
- Open communication in order to
- Integrate some existing systems
- Be open for future expansions
- Capability to handle thousands of I/Os
- Price lower than competitors
- Siemens & Schneider

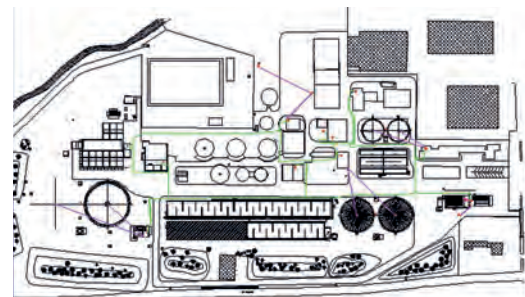

## The Multiutility Leader in Environmental, Water and Energy Services

- 4.105,7 millions/euro revenues
- 644,8 millions/euro EBITDA
- 6684 employees
- 2.9 millions residents served
- 35 millions of tourist served
- 11.926 km2 territory served
- 254 millions/m3 invoiced water
- 5107 thousand tons of waste water treated



## Challenge for Saia Burgess Controls?

- Backup between two CPUs
- Thousands of I/Os via SmartRIOs
- High volume, Multi-Master & Slave, Ethernet communications:
- ModbusIP + Ether-S-Bus + Web



**The value of the Partnership**

- Dedicated Team to define communication architecture and mechanisms: Customer & SBC ITALY & SBC Murten Business Unit
- Warm Backup mechanism and all I/Os communications (Ether-S-Bus) realized via IL code & CSFs (!)
- New PCD3.M5560 (2x)
- New SmartRIOs PCD3.T66x (17x)
- PCD3.M6540 (7x) for ProfibusDP integration
- > 2500 physical I/Os
- PCD7.D457 (1x) and PCD7.D410 (1x) for new plant units (HWTurbo, Filtration)
- ModbusTCP communication with PVSS (Siemens OA) SCADA
- Modbus communication with existing field instrumentation

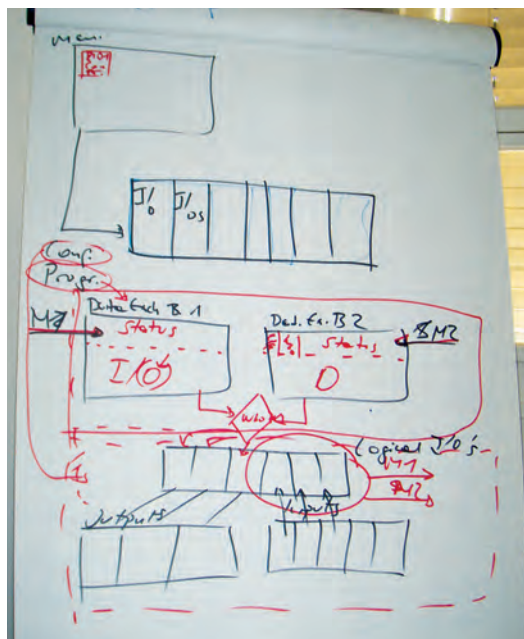

◀ Dash of R&D meeting in Murten

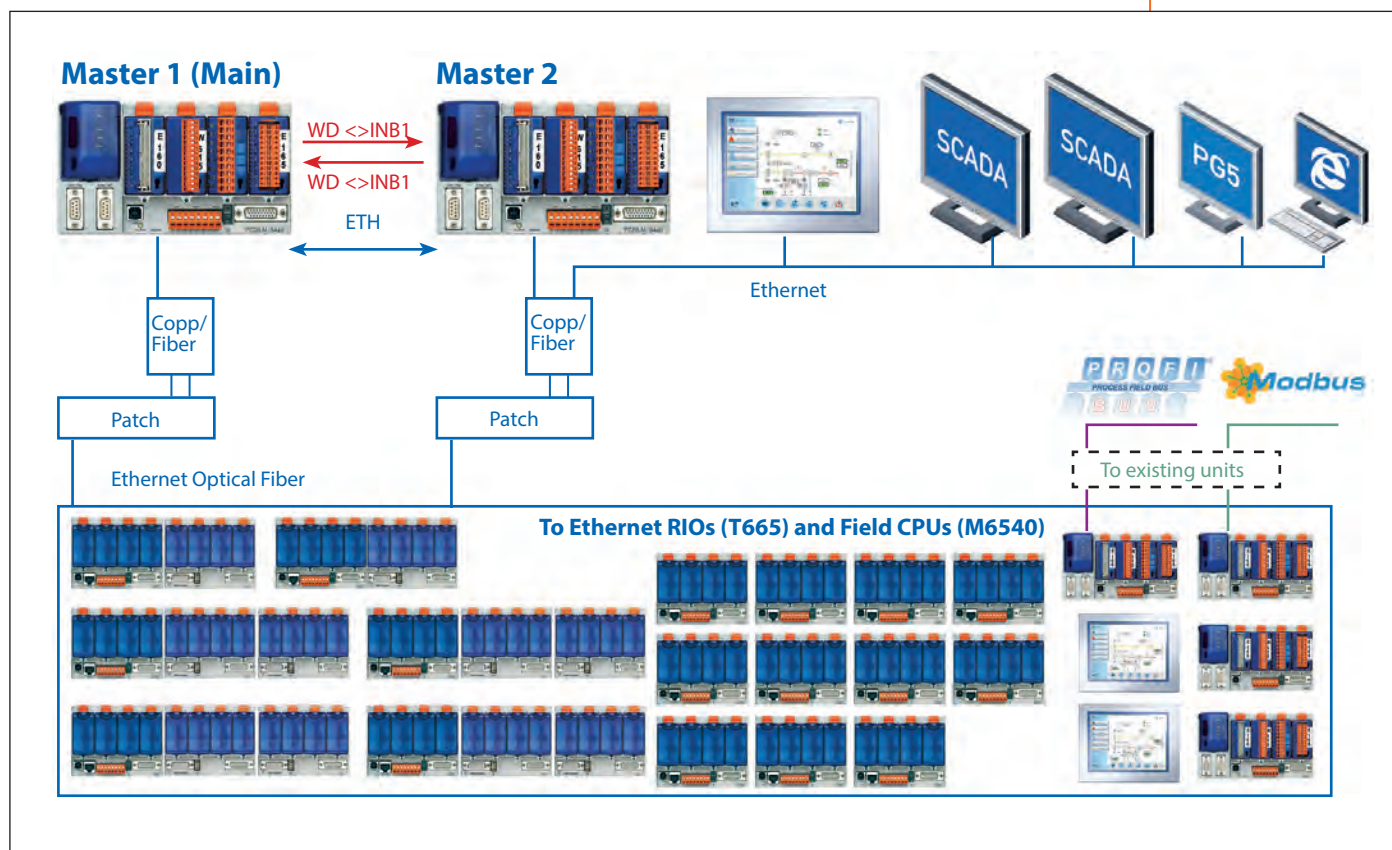

▲ Use of Saia PCD®: Plant Topology

**Our Partners:**



◀ Operator & Planer & Systemintegrator  
www.idea-srl.it





## Hotel control with touch screens and SBC App

Operator: Hilton Worldwide  
 Object: Hotel  
 Country: Switzerland



▲  
PCD3.F261

### About Hilton

„HILTON WORLDWIDE“ is one of the largest hospitality companies in the world, and they're growing faster than ever.

### Facts

- 10 different brands
- more than 3800 hotels worldwide
- 140'000 team members
- across 91 countries

In this reference story the „Hilton Garden Inn“ Hotel is presented.



Opening: autumn 2012  
 Location: DAVOS Switzerland  
 Size: 148 rooms  
 4 meeting rooms  
 wellness area

### Tasks and objectives

- ▶ Requirements of the customer:
  - Integration of different plants on a common infrastructure for communication (Ethernet/Internet)
  - Integration/combination of lighting and HVAC
  - Lobby controlling by iPad
  - Simple, but system integrated room automation
- ▶ Challenge for SBC:
  - Cover the variety of communication
  - Room controller with „top“ design
  - The implementation of DALI should be very efficient
  - Short implementation time while changing requirements

### SBC Highlights

- Digital and analog PCD3 hand/emergency modules
- Proprietary communication to Danfoss frequency converters over RS-485
- New PCD7.L645W touch screen ROU used for room controlling
- 12 New DALI Master PCD3.F261 (550 lamps)
- SBC App used to control lighting over Apple iPad
- M-Bus, MP-Bus and DALI communication used



“Saia Burgess Controls offers a homogeneous system started from the central heating system up to the design-oriented room control unit! Various communication links can be implemented easily and can be combined with future-oriented systems, such as operating on iPad! That's why we are successfully using SBC-products over 12 years, ...”

Herr Frehner  
CEO laCOM GmbH



▲ Mr. Frehner, CEO laCOM GmbH; Mr. Högger, PL laCOM GmbH

◀ Hand/emergency modules; Danfoss frequency converter

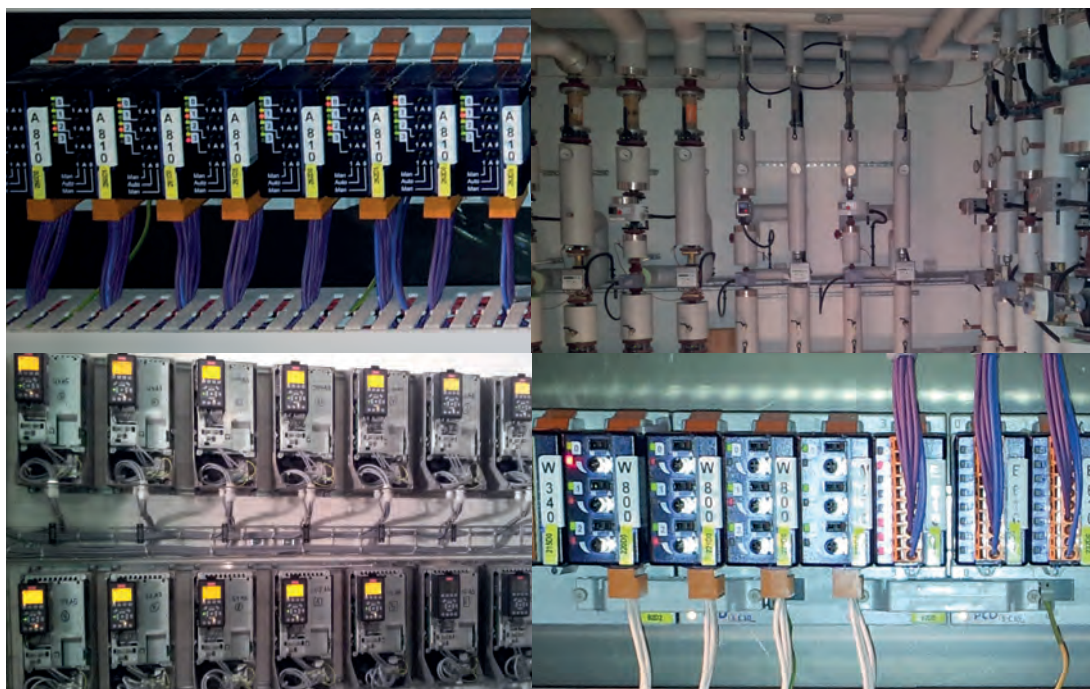

**Most important advantages for this project**

- Various communications with one system (RS-485 Danfoss, M-Bus, MP-Bus, I-Pad, S-Bus Ethernet/RS-485)
- Very nice designed room controlling...
- Integrated hand/emergency modules available...
- Huge heavac library...

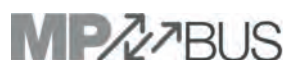

**Our Partners:**

 HILTON ◀ Operator  
[www.hiltonworldwide.com](http://www.hiltonworldwide.com)

 BeDAC GmbH ◀ Planer  
[www.bedac.ch](http://www.bedac.ch)

 laCOM ◀ Systemintegrator  
[www.lacom-gmbh.ch](http://www.lacom-gmbh.ch)

## Area of Stücki – CO<sub>2</sub> neutral energy production and distribution on 70.000 m<sup>2</sup>

Operator: IWB - Industrielle Werke Basel  
 Object: Building  
 Country: Switzerland

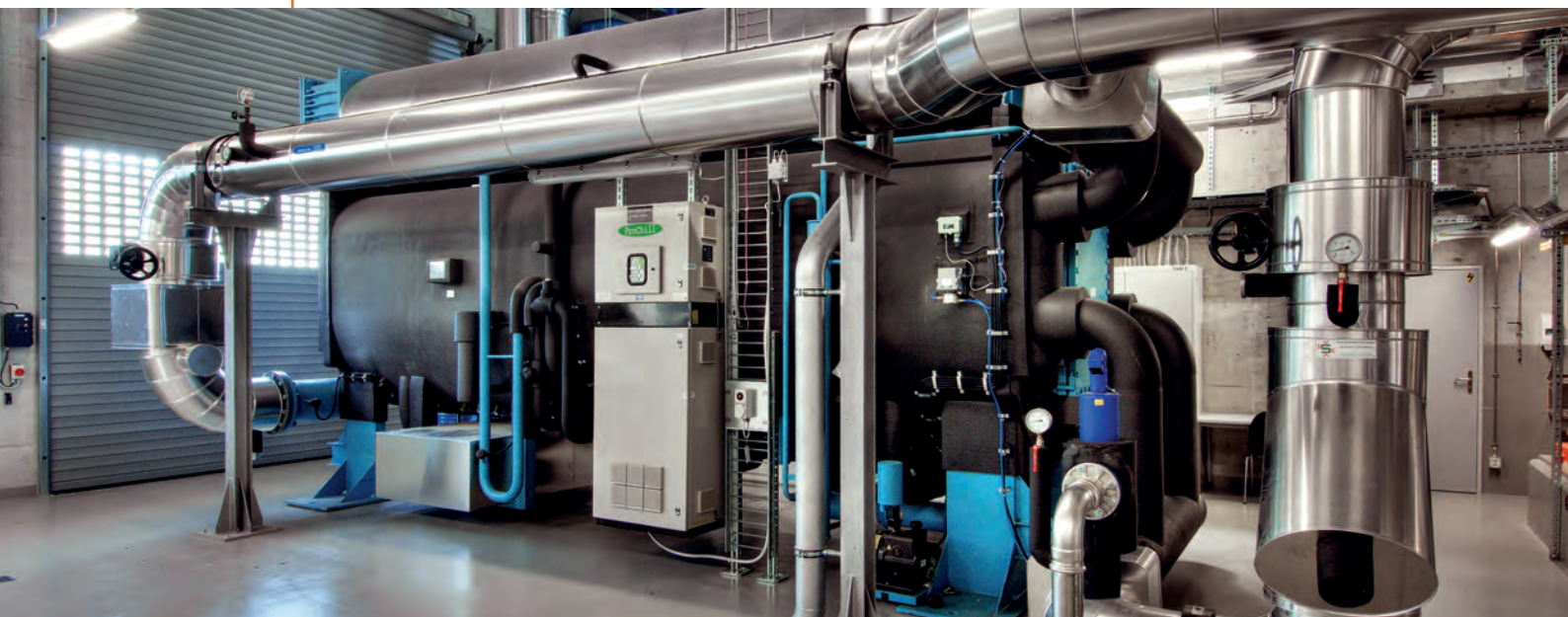

▲ Powerbox  
 Production of  
 electricity;

### Stücki – Powerbox CO<sub>2</sub> neutral energy

#### ► Abstract

The contracting system produces energy from (almost) free waste heat of sludge and waste. The waste heat is converted in cooling energy by absorption process. 3500 kW of cooling energy is enough energy to cover the requirements of the Stücki area.

#### ► Special points

The biggest absorption refrigerating machine of Switzerland was awarded for CO<sub>2</sub> neutral energy with the Watt d'Or by the Federal Office of Energy.

#### ► The target of the carrier IWB

- Sustainable and regenerative production of electricity
- Energy for business park and shopping center
- Transparency for energy production

### Tasks / requirements

#### Stücki – Powerbox – Production of energy

##### PLC task

The regulation / control of the installed refrigeration tank as buffer store, and the subsequent distribution of power to the customer is acquired by Saia PCD® technology.

### Characteristics of energy

- 3500 kW refrigerating capacity
- 110 m<sup>3</sup> cold water storage tank
- 10 million kWh of cooling energy per year
- 10 million kWh of thermal energy per year
- Operation for 8 months a year
- Free cooling in months of winter

### Integration

#### ► Powerbox – Production of energy

- Regulation / control

Physical data points: 200

PCD3.M5540: 4 pc.

RIO station PCD3.T660: 10 pc.

- Operation – Web Panel

10" Web-Panel (MB) 3 pc.

- Interfaces  
Ethernet TCP/IP – fibre optics  
Profibus DP  
Mod-Bus  
M-Bus

► **Energy consumer – shopping center / business park**

- The regulation / control of the heating and cooling energy requirements.
- HVAC – System for logistics in the shopping center and business park.



▲ Energy management with Ambus (Aquametro)

► **Key figures shopping center**

Total area shopping: 32'000 m<sup>2</sup>  
Physical data points: 225  
PCD3.M5540: 2 pc.

10" Web Panel (MB): 2 pc.

- **Key figures business park**

Office area / laboratories: 35'000 m<sup>2</sup>  
Physical data points: 1500  
PLC PCD3.M5540: 1 pc.  
PCD3.M3330: 8 pc.  
PCD3.M3230: 6 pc.  
10" Web Panel (MB): 2 pc.

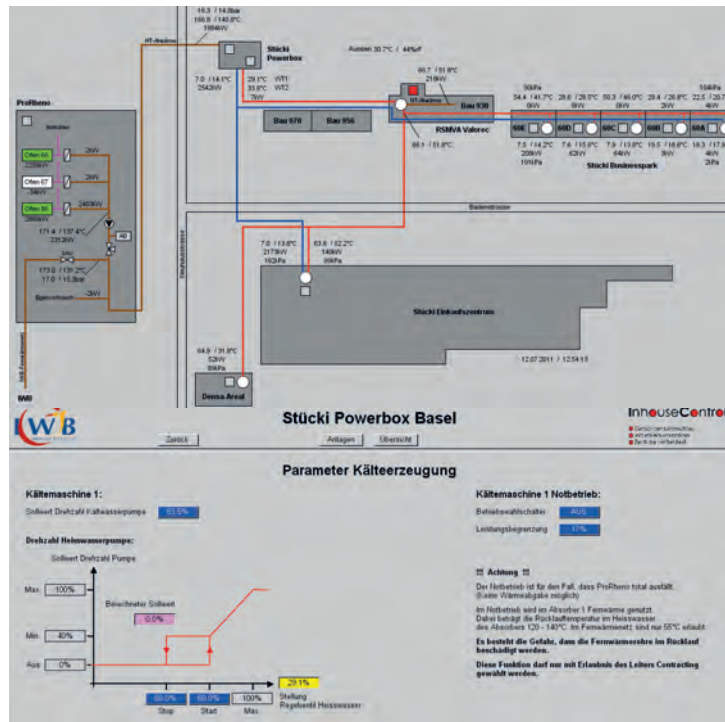

**Visualisation**

**Production of energy / business park - Visi.Plus 1.5**

- Description  
Visi.Plus for visualisation and control of heat production and distribution
- Energy supplier  
Valorec (refuse incinerator)  
ProReno (sewage clarification)
- Refrigerating machine  
Powerbox
- Energy consumer  
Business park  
Shopping center
- Special points  
Energy management system by Saia PCD®

**Stücki – Areal**

- Estimated values
- Open system
- Flexibility
- Range of communication interfaces

▲ Visi.Plus energy distribution – Stücki area

“With the use of modern engineering tools we are able to offer customized, innovative and cost-effective solutions. Our total supply offers the user a high reliability and optimum plant operation. With free choice: Our Measurement and control technology system would be Saia PCD®.”

Paul Gasser  
CEO and firm owner InhouseControl AG, Ettingen

**Our Partners:**

**Stücki** ◀ Operator  
www.stuecki.ch

**eicher+pauli** ◀ Planer  
www.eicher-pauli.ch

**InhouseControl** ◀ Systemintegrator  
www.inhousecontrol.ch

# Training facility for fire-fighters using self contained breathing apparatus (SCBA)

Operator: Kreisfeuerwehrverband Roth  
 Object: Fire and smoke simulation room  
 Country: Germany

Gefördert durch:



Bundesministerium  
für Wirtschaft  
und Technologie

aufgrund eines Beschlusses  
des Deutschen Bundestages



◀ Passing narrow obstacles with full SCBA equipment



◀ Treadmill and endless ladder for generating physical stress

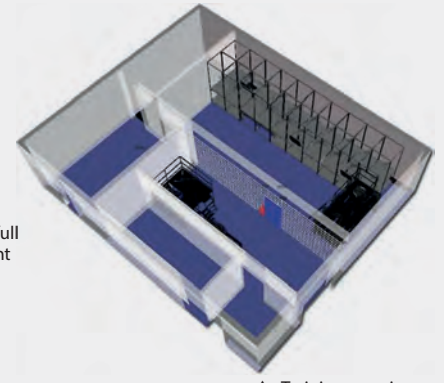

▲ Training exercise course for SCBA equipped rescue workers

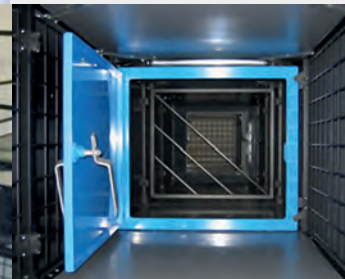

▲ Iron-barred boxes simulating difficult passage ways / Shutting off gas without sight and under high stress level / Simulation of lock gates and debris

## SCBA training for rescue workers of fire brigades

Fire brigades instruct their rescue workers in own training facilities. SCBA training including handling authentic events of sudden danger:

- Live saving
- Preventing explosions (gas)
- High level of physical and psychological stress
- SCBA training exercise course simulates real live situations
- Realistic simulation with fog, heat, acoustic shocks and light effects
- Continuous surveillance of rescue worker Position
- Physical condition
- Concept & realisation made by www.mawonline.de
- Build-up of first prototype at Roth close to Nuremberg

## Training course & exercises

Before entering training exercise course, rescue worker is physically stressed wearing complete SCBA equipment. Rescue worker passes training exercise course equipped with obstacles according typical usage conditions

## Automation improves safety and quality

- All-over surveillance of test person
- GPS base location of position
- Full automated, precise control of effect devices, initiated from motion detectors
- Former training exercise course was operated manually
- Complex operating of effects
- Insufficient reproducibility of test runs
- With automation, test results are 100% reproducible and comparable

## Implementation with Saia PCD3

- Control and supervising of training exercise course using PCD3.M5340 with Ethernet interface
- Direct connection of effect and location systems to the controller via TCP/IP and UDP
- Visualisation of control room with Browser based operating, made with Saia Burgess Controls S-Web Editor
- Realised from www.retech-gmbh.de



**Benefits for end-user and system integrator**

- Considerably more realistic training for rescue workers of fire brigades
- 100% reproducible exercise runs
- Training facility is offered all over Europe
- In plan: 20 installations p.a.
- Saia PCD3 optimal covers requirements
- Communication to effect and supervision systems
- Embedding of colour graphics using HTML and web server

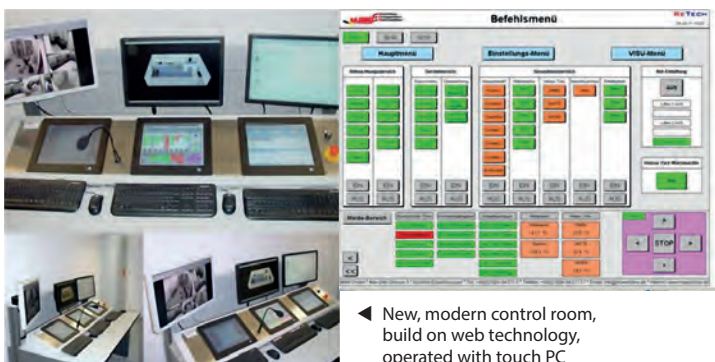

◀ New, modern control room, build on web technology, operated with touch PC

Supply duct for hot air and fog ▶



Motion detectors and effect devices of training exercise course ▼



▲ PCD3.M5340 with ca. 70 I/Os

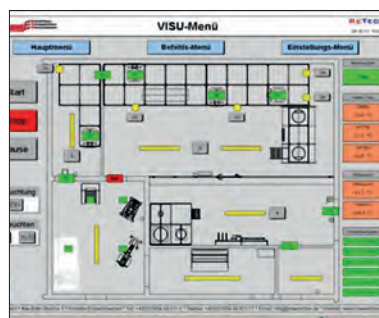

◀ GPS based locating of test person via web visualisation

**Our Partners:**

**MAWE** Metallbau Anlagenbau Winkelsitzungen ▶ Planer  
www.mawonline.de

**RETECH** ▶ Systemintegrator  
www.retech-gmbh.de

## Office renovation

**Operator:** Leger des Heils Utrecht (Salvation Army)  
**Object:** Building  
**Country:** The Netherlands



### Building at the Zeehaenkade Utrecht

A printing office was accommodated in the building ever since the new housing estate in the seventies; As of 2000, it is used as the office and as hall of the Salvation Army Utrecht.

It has 120 workplaces for the task group Youth Care & Rehabilitation. In the hall there is space for collecting and selling second-hand clothing and other goods.

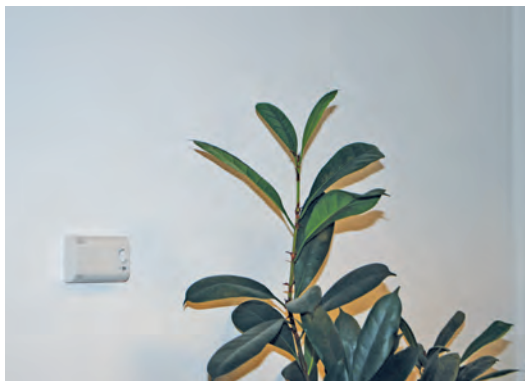

► Comfortable Room automation

### Renovation with a challenge

- Renovation with partly newly built offices in 2009: Building was characterized by a high use of energy and by climate problems
  - Challenge is to raise the comfort and to reduce the use of energy within a limited renovation budget
  - The changes need to fit in the old technical installation, with for example the HVAC-cabinets which were installed for the printing office in those days
- IHCS was assigned to analyse the HVAC-installation and the control engineering. They published an

advice report with concrete recommendations, for example the placement of an adiabatic moisturizer. And took into account the limits of the power supply and electrical distribution.

### Configuration

- 2x PCD3.M5340 with 117x I/O points, 1x SD-Flash, 1x MB Panel, 30x PCD7.L703 Room Controllers and 5x S-Bus energy meters
- Modbus RTU to Danfoss frequency inverters and steam moisturizers
- S-Web application for visualisation, control, trending and alarming

### Controlled by Saia PCD®

- Heat generation by 2 pumps
- 1x Cooling machine
- 2x Airhandling-units
- 2x Exhaust fans
- Warm water
- Room automation
- Measuring of energy



▲ Enough space left in cabinet by the old controller

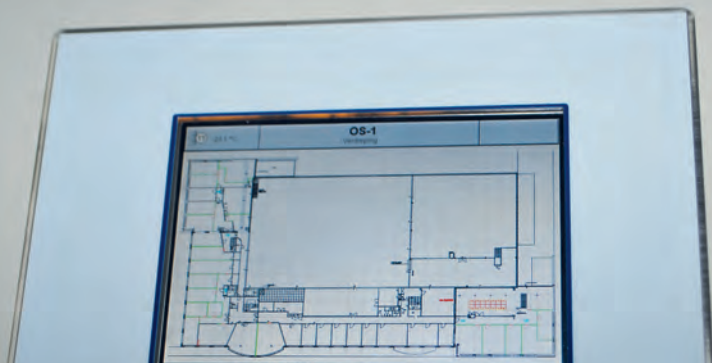

▲ Userinterface by Web

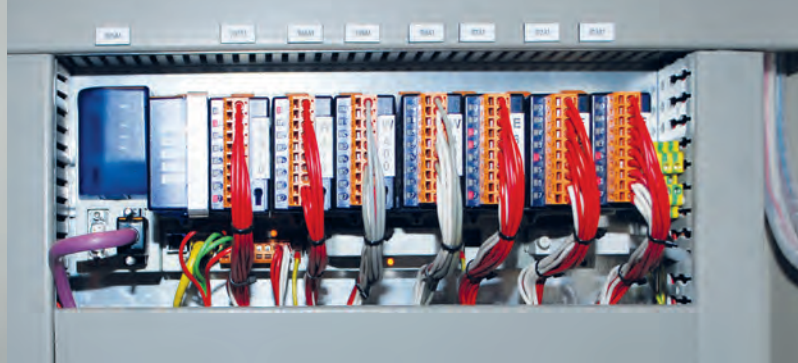

▲ PLC+Web+IT in the cabinet

▼ Topology

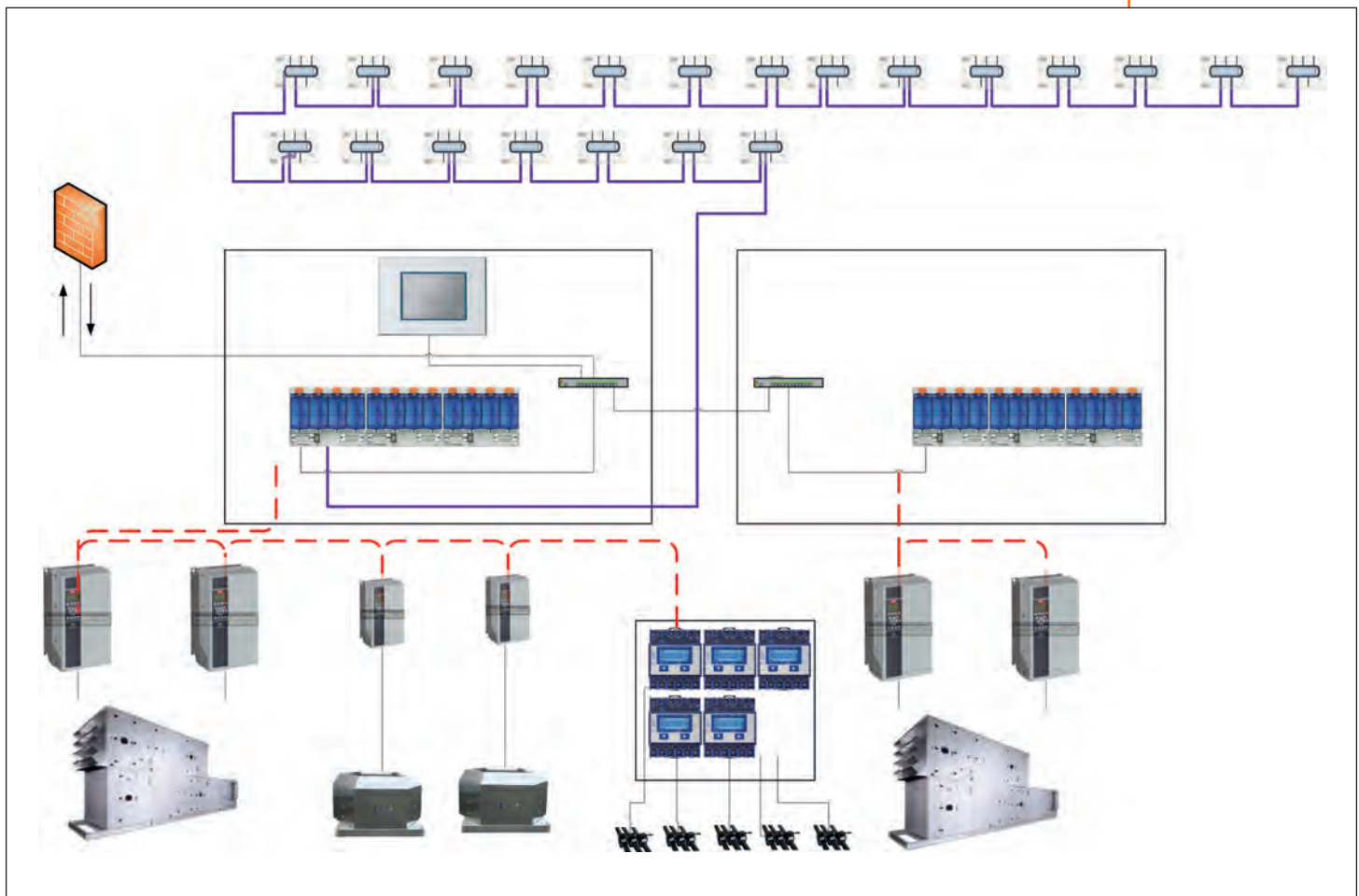

**Testimonial**

- Result of the renovation for the Salvation Army is
- Comfort in the office and in the hall
  - Affordable energy bills
  - Retrofit by using PCD and Web+IT-technology within the existing installation



◀ Airhandling unit (Topology)

**Our Partners:**



◀ Operator  
portal.legerdesheilsutrecht.nl



◀ Planer & Systemintegrator  
www.ihcs033.nl

# Production and development of cranes and large sunshade constructions

Operator: Liebherr-Werk Ehingen GmbH  
 Object: Industrial Sites  
 Country: Germany

# LIEBHERR



▲ Sunshades  
 Telescopic- and lattice boom  
 for mobile and crawler cranes  
 Production hall 3  
 400x150x25m (LxWxH)



▲ Complex management  
 at the SCADA system



▲ Web based visualization  
 on site

## Liebherr | Ehingen | Germany

### Site and characteristic

The Liebherr-Factory Ehingen GmbH is one of the largest factories within the Liebherr group.

### Facts

2800 employees  
 19 production halls  
 4 office buildings  
 840.000 m<sup>2</sup> base area  
 230.000 m<sup>2</sup> floor space  
 Energy consumption correlates to  
 5000 households  
 1400 mobile cranes per year  
 Large sunshade constructions



### Realization / Functions / targets

Company Elektro Hofmann, a long experienced System partner with 70 employees ensures since 12 years the disposability for more than 200 Operational ranges inside the productions halls and offices:

- Illumination (in door/out door/safety)
- 30 Compressors for compressed air (1,5 MW) with heat recovering
- Heating (1000 heater with 30.000 kW)
- Cooling by heat pumps (500 kW)
- 12 tank system (400.000 Liter oil and diesel)
- 300 Gate- and door monitoring
- Shade/Light and more

### ► For this we need:

- 80.000 field data points
- 40.000 data points visualized on the SCADA System with 1500 scheduler and more than 3500 alarm messages
- 10 web based operation panels in the operational ranges
- 60 Automation stations of PCD, with more than 200 safety relevant circuits relies on there IOs only



**Realization of lasting building automation „Everything is possible“**

The over decades homogeneously grown location requires interoperability with highly heterogeneous systems of existing and planned installations.



Organize the complex production enables for more than 200 operation areas in 19 production halls.



Controls the luminosity of about 1000 lights depending on the day light separated in 20 DALI lines.



Detects 500 energy measurement points from Janitza heat / gaze / electric.



Controls and monitors safety relevant. CO / NOX concentration inside the goods hall.



80.000 fieldbus data of sensors and actuators, including 10 weather stations to enable production areas.

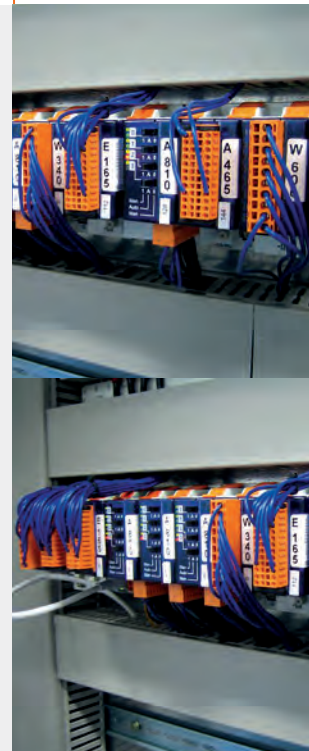

▲ Multi interfaces for DALI power Safety = Hardware of I/O-cards

**Lean Automation**

Smart Integration of different systems by world wide standards

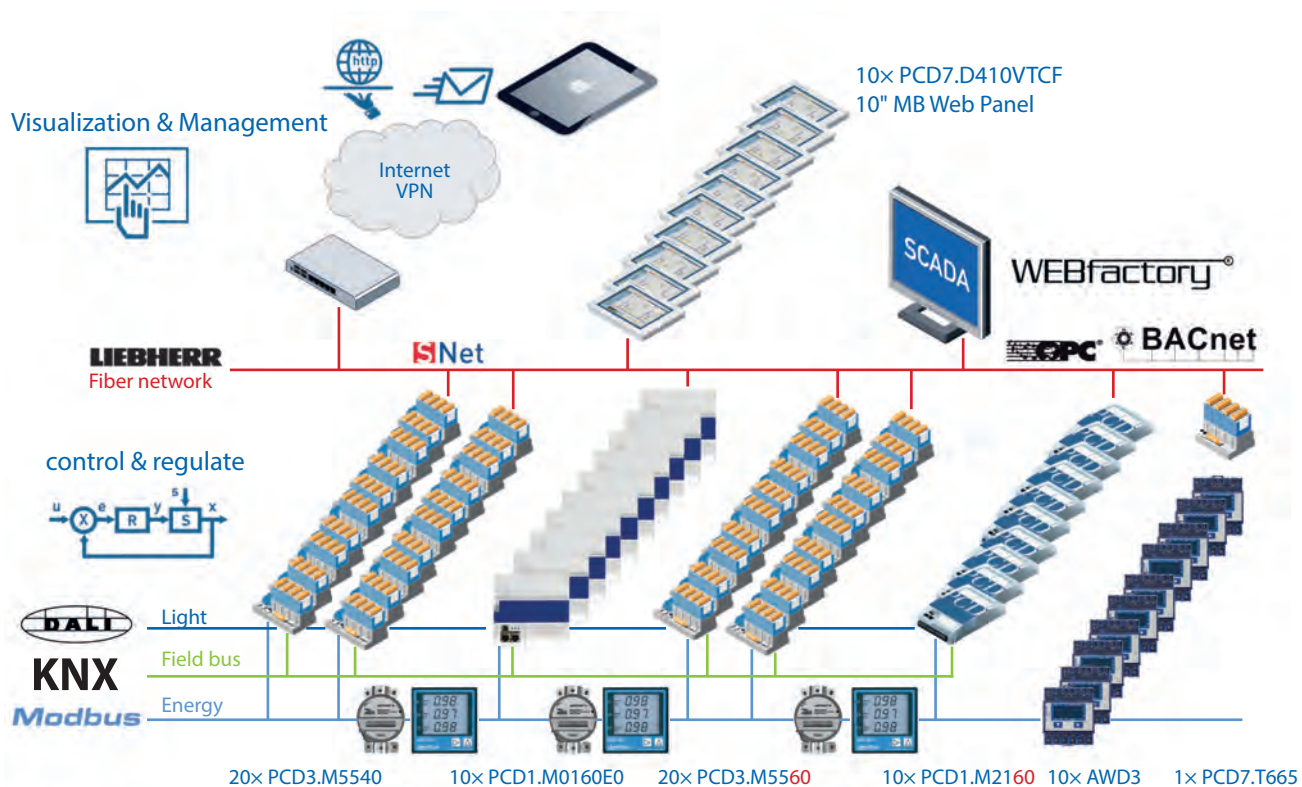

Web based operation terminal Technology combination for more transparency

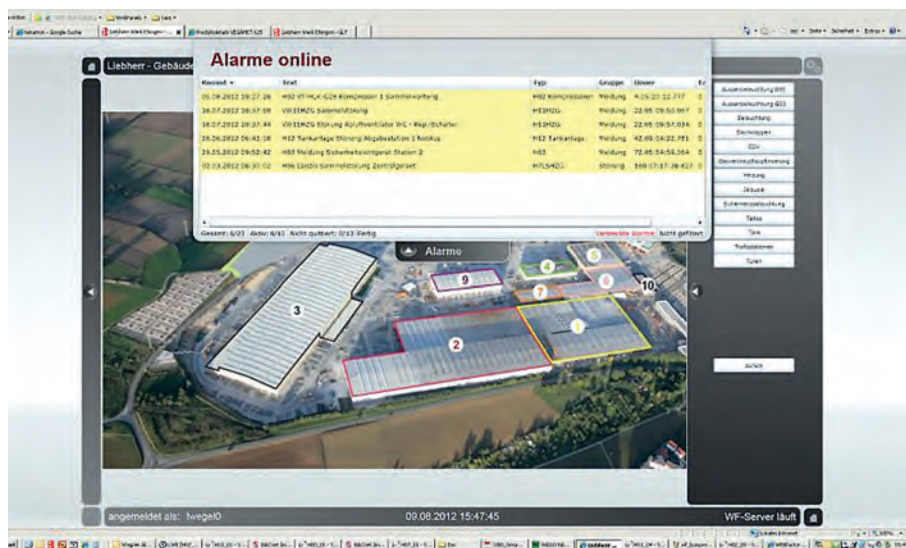

Central information page including actual alarms

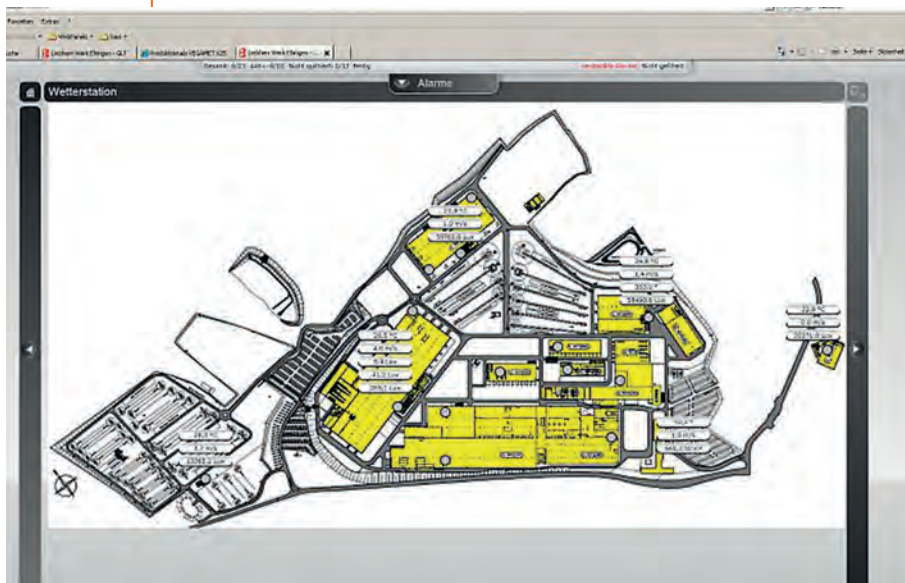

Overview Illumination

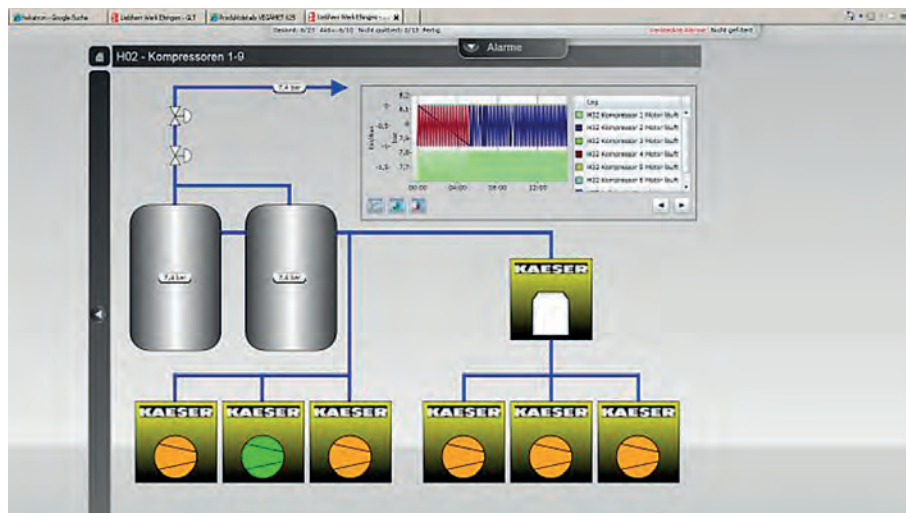

Tank monitoring

Cooperation & automation server / Perfekt Fit for the building automation

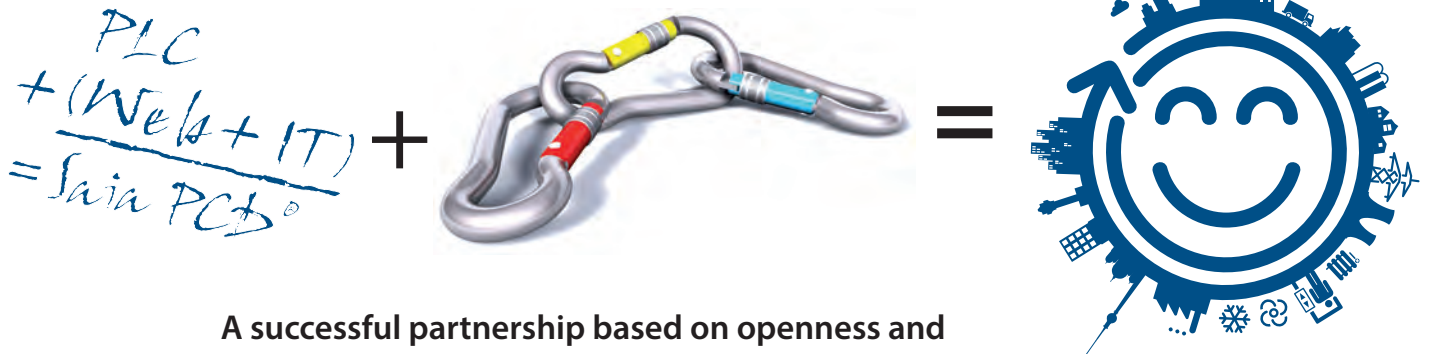

A successful partnership based on openness and transparency between **Manufacture** – **Integrator** – **Endcustomer** guaranties a lasting supply chain for efficient infrastructure operation.

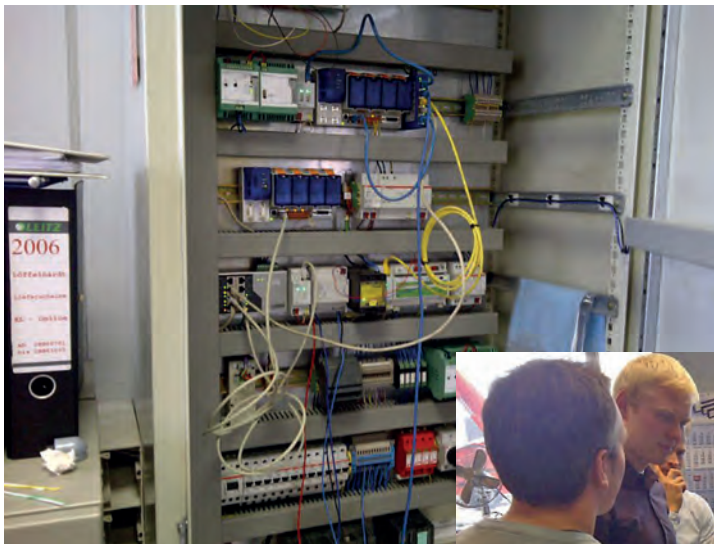

◀ Test facility for process optimization

Field test with manufacturer on-site ▶



Systems will be permanently optimized over the lifecycle, this leads to „perfect fit“ of the building automation.

The tool for that: The engineering suite **Saia PG5®**

grows and stays since **12 Years** compatible!

**Our Partners:**

**LIEBHERR** ◀ Operator  
[www.liebherr.com](http://www.liebherr.com)

 ◀ Systemintegrator  
[www.e-hofmann.de](http://www.e-hofmann.de)

# Optimising and controlling one of the world-wide biggest satellite broadcasting installation

**Operator:** MEDIA BROADCAST GmbH  
**Object:** Satellite technology  
**Country:** Germany



## MEDIA BROADCAST GmbH

MEDIA BROADCAST is Europe's biggest full service provider in the broadcasting and media branch. At the Teleport in Usingen, MEDIA BROADCAST operates over 80 satellite antennas featuring diameters up to 20 m. From this location data, pictures (TV) and sound is transmitted to all-over the world.

### Facts

Headquarter: Bonn

### Project realisation „History 97/98“

Control of satellite end units (amplifier, signal converters)  
 Implementing complex drivers (AWL/ FUPLA)  
 Control of 6 end units per PCD6 (serial, modem)  
 Communication Profibus FMS (Wonderware Intouch)

### Key figures

PCD6 controller:	10
I/Os	6.000
Wonderware Intouch I/Os:	21.000

### Project requirements „New 11/12“

- Replacing old satellite controller with PCD3
- Porting software from PCD6 to PCD3 (from PG3 to PG5)
- Control of min. 6 end units per PCD3 (amplifier, signal converters ...)
- Intelligent control of antenna heating (avoiding current peaks)
- Replacing Profibus FMS with OPC

Implementation of an intelligent antenna heating control system preserves the environment and cuts electrical power cost of the terrestrial broadcasting station usingen.

## Lean optimisation phase 1

### Achieving today's project requirements

- Little adaptation of the user program for porting to PCD3.M5560
- Replacement of 10x PCD6 with 10x PCD3.M5560 including 3x PCD3.F221 and I/O's
- Establishing serial connection to satellite end units (PCD3.F221)
- Configuring OPC server for data communication; linking Intouch SCADA via S-Bus
- Download new user program and restart PCD3
- full function again available

## Lean optimisation phase 2

- Automation system allows self-contained extension of user program
- Programming of an intelligent antenna heating control (FUPLA)
- Only one training course for handling the automation system was necessary

Simultaneous heating of all antennas at the same time is now avoided, no expensive power peaks anymore; 80x Saia PCD energy meters measure the power consumption (ALE3/AWD3). Possible savings per heating period: 325.000 kWh.



▲ PCD3 / Satellite control



▲ PCD6 satellite controller

**Maximum value combined with maximum efficiency**

Thanks to the lean automation system of Saia Burgess Controls, MEDIA BROADCAST achieves an optimum of efficiency in their value creation chain. Preserving software investment during the whole life cycle. Tremendous time saving while rebuilding of installation / Minimal changeover cost Thanks "PLC + (Web + IT) = Saia PCD®" always state-of-the-art technology Secure availability of new control technic thanks portable software / Minimal risk Open automation system / Self-contained program extensions are possible (end user)

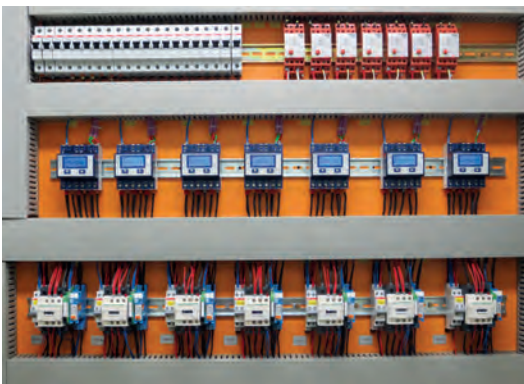

Measuring consumption of heating ▲



◀ SCADA satellites

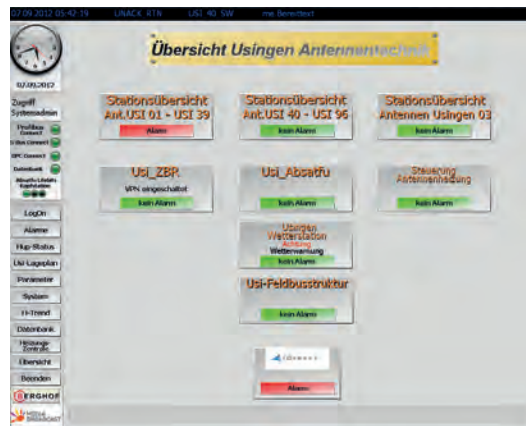

◀ Operating antennas



◀ Intelligent antenna heating

**Our Partners:**



◀ Operator [www.media-broadcast.com](http://www.media-broadcast.com)



◀ Systemintegrator [www.berghof.com](http://www.berghof.com)



## Automation of the Medicina clinic in Héviz

**Operator:** Medicina clinic  
**Object:** Clinic  
**Country:** Hungary

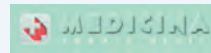

### Main information of reference story

- Main data of clinic
  - A small private clinic in a famous Thermal-Bath town
  - 8 clinics department (dentistry; oral surgery; cosmetic surgery; dermatology; cosmetics; optics; rheumatology; cardiology; urology)
  - There was local controllers only at all BA equipments without supervisory possibility
  - 3 building phase
- Main data of SI (Becskő László)
  - Small local engineering office with 2 own employees and cooperation with a panel-builder
  - Experiment in Saia PCD® application (in building automation)
- Especially challenge for implementer
  - The owner consider it necessary to define all of its specially regulation and visualization requests

### Especially climate applications at MEDICINA clinic

- First building phase
  - Sterile operating room control with:
    - Steril Filter
    - Constant temperature
    - Overpressure
    - Uninterrupted operation
    - HEVAC Control of surgeries
    - Sending of critical error messages

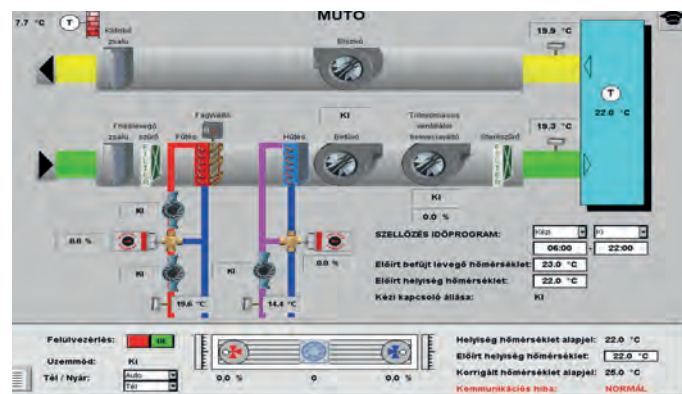

- Second building phase
  - Heating-pump control
  - Electrical energy measuring
  - Several other information collection
- Third building phase
- A solar system control and integration into:
  - Heating stoker control
  - Boiler control
  - Fan-Coil hot water control
  - A new heat-pump integration
  - Control of puffer-tank

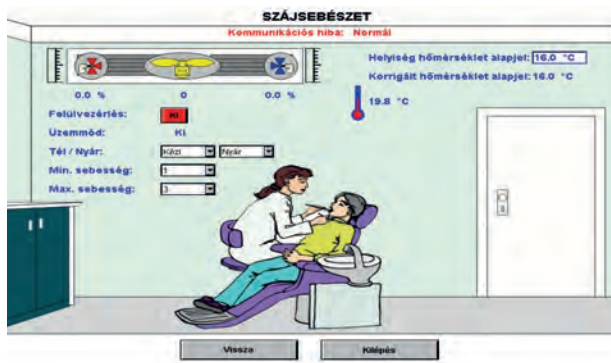

◀ Applications and solutions of WEB - visualization, A realistic picture from PCD3

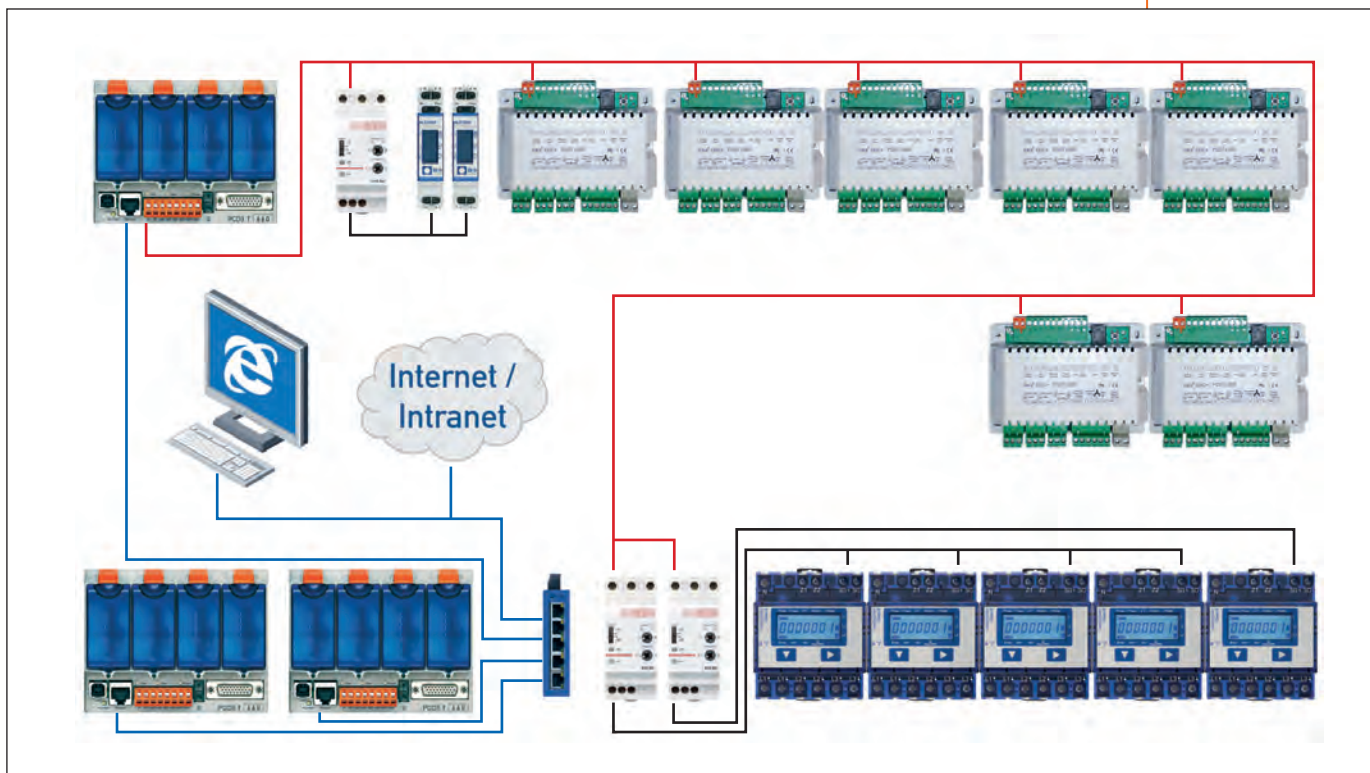

▲ „green” solutions

**Benefits...**

- **Benefit of end-user**

Our PCD offers a real integration of several systems and equipments. The application is able to expand step by step. Our PCD system is able to show all of its information in WEB form without other PC in very realistic pictures.

Our SI was very flexible to solve all special requests of owner.
- **Benefits for SI**

There is a strong and flexible delivery and support background by Saia-Burgess Controls AG and local Representative behind the Systemintegrator.



**Our Partners:**



◀ Operator  
www.medicinaklinika.hu



◀ Planer & Systemintegrator  
www.sb-controls.hu

## New energy efficient hotel and spa in the seaside resort

Operator: Mera  
Object: Hotel  
Country: Poland

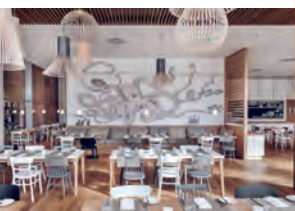

### Location and Characteristics

A newly built hotel complex and spa is located in the exclusive seaside resort in Sopot, north Poland.

- Hotel
  - 145 rooms and apartments
  - 36 beauty salons
  - 3 indoor pools + 1 outdoor pool
  - 4 floors + 1 basement level
  - 17.000 square meters
- HVAC
  - 9x AHU – PCS1.C8xx
  - 18x VAV – PCD2.M5xxx 4x MP-Bus
  - 1x heating chamber – PCD2.M5xxx 2x MP-Bus

### ➤ Hotel operator



6 hotels in Poland, Estonia, Latvia, Lithuania

### Tasks and Objectives

- Requirements of the customer?
 

The operator having experience with other similar objects based on Siemens SBT, Schneider / TAC, Johnson Controls and was looking for something better with greater flexibility and long life cycle.

The hotel operator joined actively in the selection of the automation system for BMS before the start of construction.

### ➤ Challenge for Saia Burgess Controls?

The customer conviction that our solutions will provide: Long live cycles, flexibility for further expansion, Integration of different communication protocols, price of the automation system will be competitive to other competitive offers

### Use & Benefit

- Use of Saia PCD® System
  - 1000 HW data points
  - 18x CPU (PCD2.M5xxx, PCD2.M170, PCD1.M1xx, PCS1.C8xxx, ...)
  - Room control (PCD7.L6xx)
  - 16x energy meters with S-Bus (ALE3 and AWD3)
  - 6x types of fieldbuses used (S-Net, Modbus, 6x MP-Bus, M-Bus)
- Benefit for MERA
  - Long live cycle
  - Industrial devices
  - Price for BMS will be comparable with other competitive offers
- Why did they choose Saia Burgess Controls?
  - Built trust for devices manufacturer, distributor and system integrator
  - Customer saw the benefits of POM
  - Quoted price for BMS after redesigning was in the budget
  - We offered additional opportunities for advanced control and integration



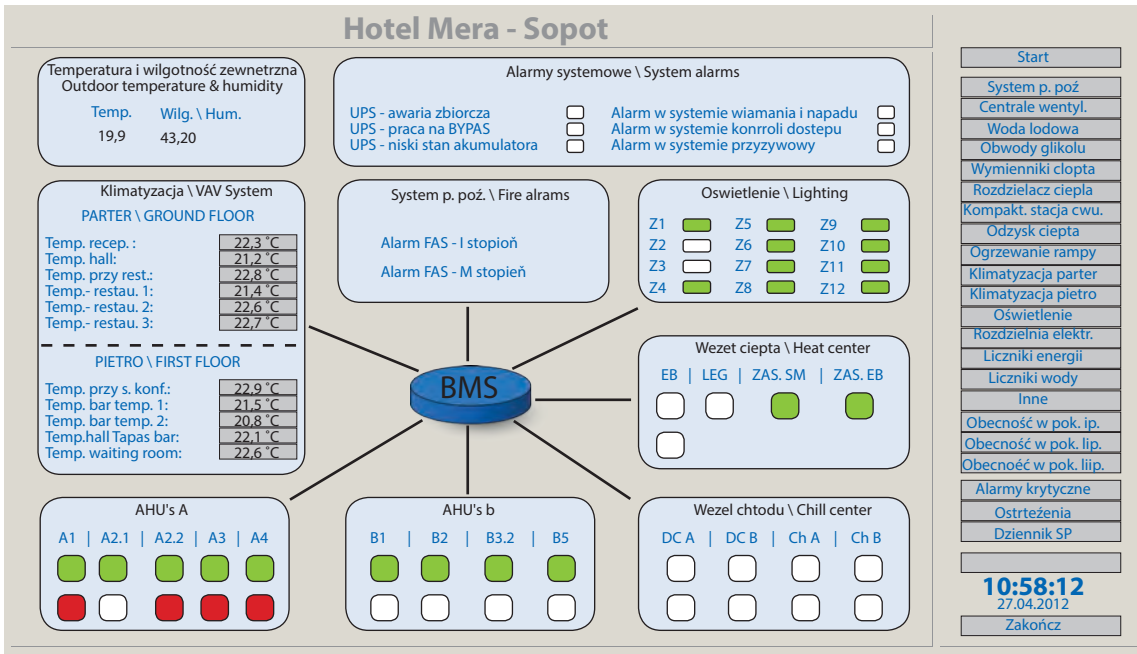

Implementation Installation integrated into the BMS

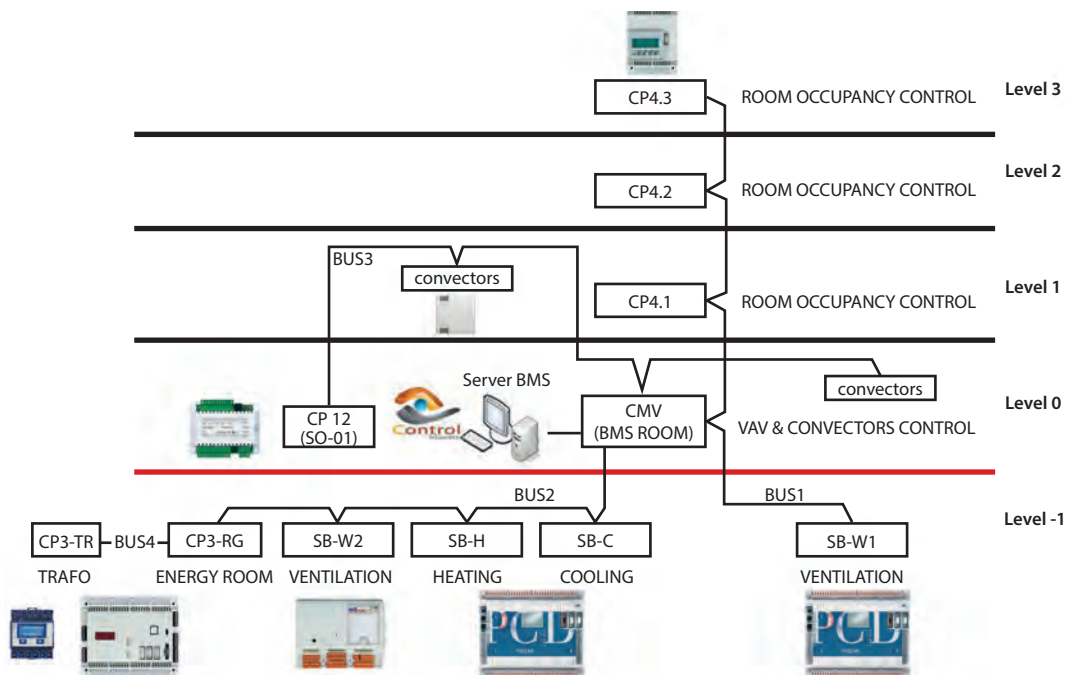

Implementation System design

**Our Partners:**



Operator  
www.meraspahotel.pl



Planer & Systemintegrator  
www.postekom.pl



# Control, regulation and communication of Minin shop's systems

Operator: Minin  
Object: Fashion Shop  
Country: Italy



## Minin Fashion Shop (MININ Family)

History... Began in 1930 with Francesco Minin. Today the business is expanding and it is based on modern sales principles. The shop covers 5000 sq/mt with 50 employees able to deliver an efficient, fast and accurate fashion sale service.

### Control, regulate and communicate

- Guarantee maximum comfort inside the 5000 sq/mt of the MININ's shop. All systems will be controlled by Saia PCD® with WEB user interface
  - First step: Revamping AHU absorption tower.
  - Next step: Revamping of all plant's systems: Rhoos heating, irrigation, pumping station,
  - AHU systems and power consumptions (S-Energy)
- Implementation
  - 1x PCD3.M2130V6, 1x PCD3.M5560, 8x PCD3.T665,
  - 11x PCD3.E165, 11x PCD3.A465, 13x PCD3.W340,
  - 4x PCD3.W410, 9x Q.PS.AD2.2405F, 9x Q.NET.5TX,
  - 1x ALE3D5FS10C2A00, 1x AWD3D5WS00C2A00
  - 196x digital inputs
  - 179x digital outputs
  - 108x analog inputs
  - 18x analog outputs

## Benefit

At the beginning Idrotermica Buttrio did the revamping of the absorption plant. When the end-user touched and felt the benefits of WEB based user interface and PLC flexibility they decided to renew all the technical shop plant with Saia PCD®!

One of the winning point was, thanks to WEB based user interface, to have a simple, efficient and distributed operator interface, both local with browsers and remote with iPhone and iPad.

Control and efficiency in HVAC (HVAC+DDC libraries). Remote access and maintenance.

## Revamping absorption tower

First Installation (March 2012)

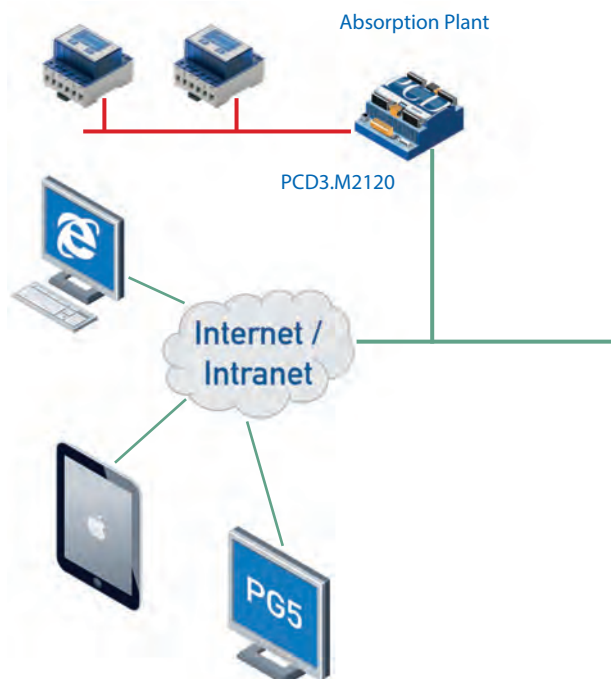

▲ Absorption plant's cabinet

Full plant topology (September 2012)

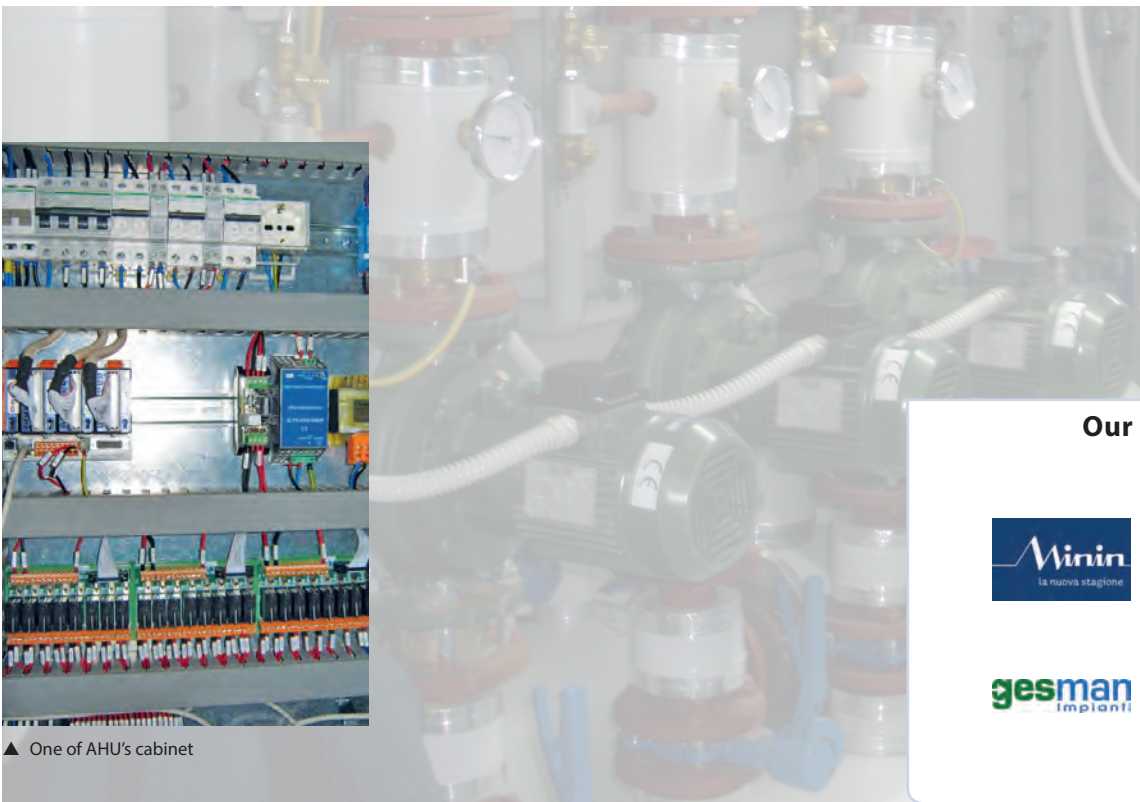
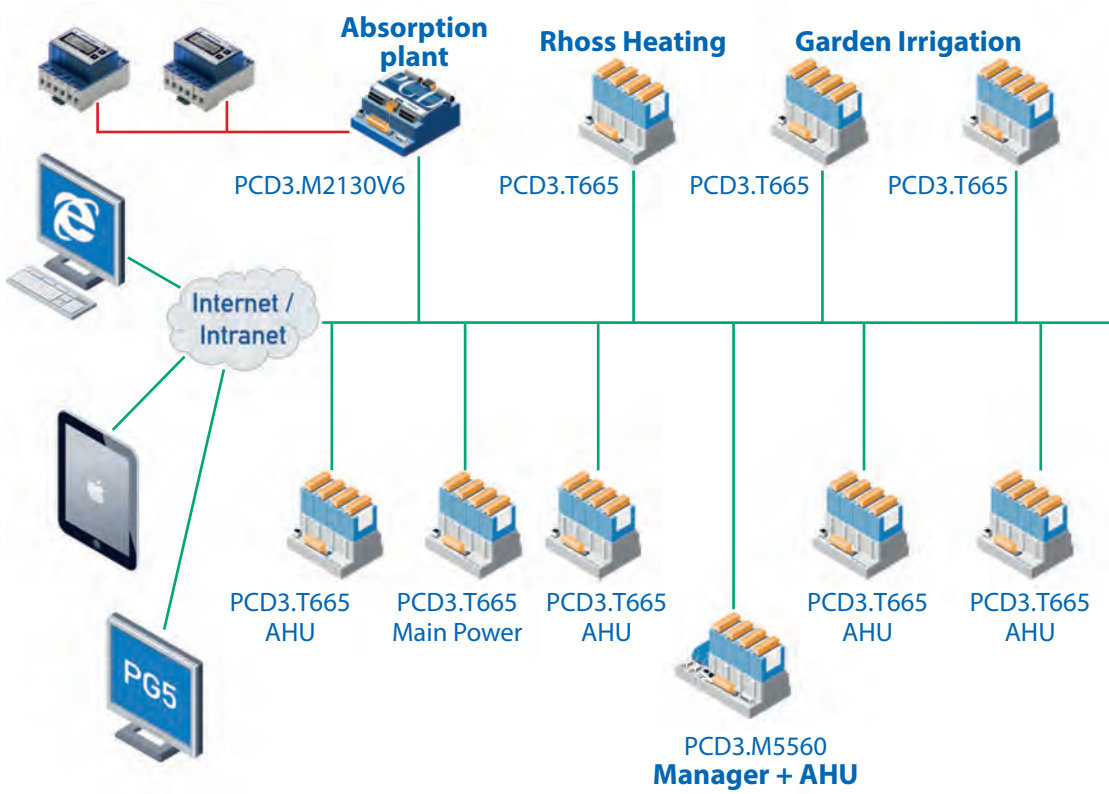

▲ One of AHU's cabinet

Our Partners:



◀ Operator  
www.minin.it



◀ Planer & Systemintegrator  
www.gesman.eu



## Energy Saving in municipal housing

**Operator:** MKB Fastighet AB  
**Object:** Housing  
**Country:** Sweden



**Operator: MKB Fastighet AB**  
**Systemintegrator: Nea-group**

► MKB Fastighet AB

MKB is Malmö's largest real estate company with 22 539 (22 238) apartments and about 1,100 commercial premises.

MKB has a market share of 33 percent of the rental market and the company is Malmö's largest landlord.

MKB's share of the total housing stock in Malmö is 15 percent.

► The NEA-group

We have nationwide coverage today. Our field of activity is electrical contracting, motor workshops, hoisting equipment and automation. We are one of Sweden's largest electrical contractors. We focus towards industry, public administration and building construction companies.

- Owner: Imtech N.V.
- More than 60 locations
- Approx. 2200 employees
- Sales 2500 mil SEK

**Upgrading heating system**

► Nea Teknik has been commissioned by the MKB to upgrade existing heating systems with new PLC based control systems. The contract covers more than 200 houses for four years. Each house has one to two heating plants.

Nea Teknik will use about 200× PCD1.M2120 and more than 100× PD3.T666 and a lot of I/O cards for the task. Visi.Plus will be used as SCADA system.

**Benefits with Saia Burgess Controls System**

The openness of the control system is the main advantage compared to vendor-specific systems. Due to the web server functionality in Visi.Plus, the maintenance personal can monitor systems through their service computers.



# Saia Visi.Plus

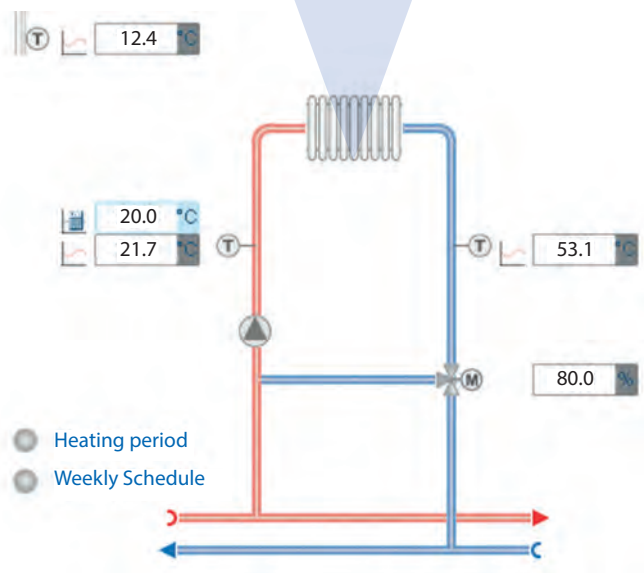

### Our Partners:



◀ Operator  
www.mkbfastighet.se



◀ Systemintegrator  
www.nea.se



## OBI Market Trutnov

**Operator:** OBI Česká republika, s.r.o.  
**Object:** DIY Store  
**Country:** Czech Republic



### Characteristics of user

OBI is one of the leading European DIY (Do It Yourself) brands offering a wide range of home improvement and gardening products. Currently, the company operates in 13 central and eastern European countries more than 580 stores, thereof more than 340 in Germany. Today the Group has more than 43.100 employees. In Czech Republic there are 33 stores with more than 2.400 employees and several more are still under construction.

In year 2012 a store has been opened in Beroun, city close to Prague and now another one will be opened in north-east Bohemia region city Trutnov. Those new two stores are „controlled“ by Saia PCD®.

### Customer expectations

- ▶ Requirements of OBI
  - Reliable and flexible solution covering all operational needs
  - Solutions without operational troubles
  - Possibility of connection other actuators and sensors vendors
  - Spare part accessibility, quick replace damaged or failing parts
  - Remote monitoring and maintenance
  - More communication possibility – Dali, M-Bus
  - Reasonable costs
  - Repeated solutions
- ▶ Challenge for Saia Burgess Controls
  - Universal solution with Web access for local and remote monitoring, maintenance and service
  - Repeated solution

### Implementation

- 1× PCD2.M5540
- 1× PCD2.M5440
- 2× PCD7.D457STCF
- 10× PCD2.W340
- 9× PCD2.W605
- 12× PCD2.E165
- 10× PCD2.A465
- 1× PCD2.F2710

Total 192DI / 160DO / 80AI / 54AO data points

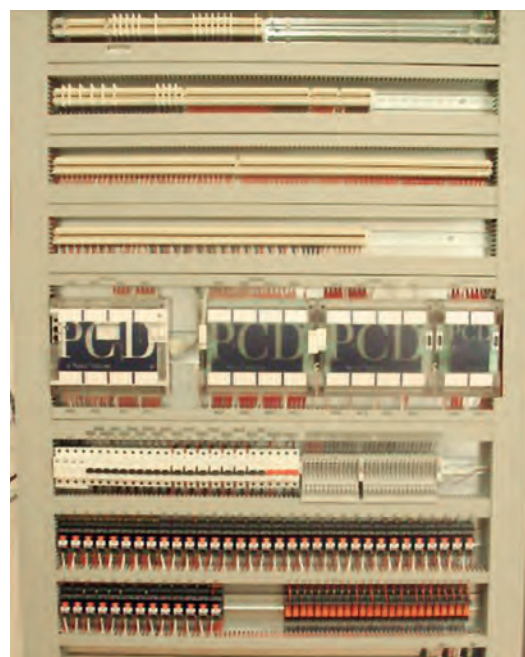

▲ Saia PCD® layout in Cabinet #1

**Why OBI chose Saia PCD®**

- ▶ PCD acceptance for OBI solution (one year procedure)
  - Web+IT technology in PCD presentation done by Saia PCD® – distributor (EWWH)
  - Sample project preparation by Mareš
- ▶ PCD installation
  - 2 projects prepared for first installation. Project of Beroun location was realized without any problems.

▼ Schema of Saia PCD® deployment

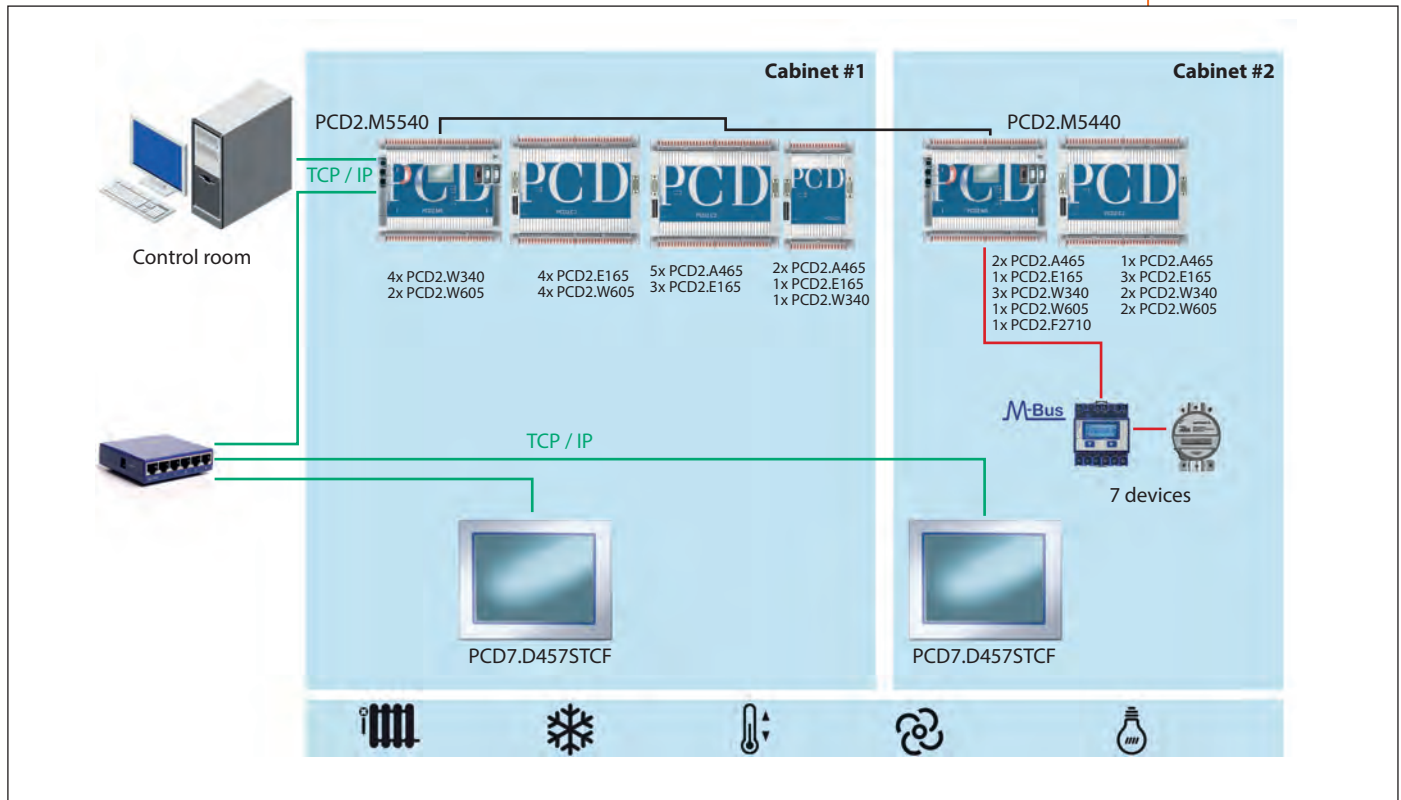

◀ Saia PCD® layout in Cabinet #2

**Our Partners:**

**OBI** ◀ Operator  
www.ob.cz

**Mareš a spol., s.r.o.** ◀ Systemintegrator

## Building Automation in rebuilt process Industry

Operator: Øra Industri Park  
 Object: Building  
 Country: Norway



**Fredrikstad by the River, Øraveien Industripark**  
 Old Production Factory named Denofa founded 1912 with production of whale oil and margarin. 2005 reconstructed to an Industripark

Owned by



### ► Key Figures Øra Industripark

Deep water kai:	500 meters
Industry area:	300 dekar
Tank capacity:	65 tanks / 114.000 tons
Building area:	48.000 m <sup>2</sup>
Number of buildings:	40 pcs.
Parking spots:	200 pcs.
Employed in the Park:	160 persons

### Implement new automation for energy saving and control

To implement new systems as ventilation, distribution of heating and energy management into old buildings with existing systems to have control with the environment and energy.

- New use of most existing buildings
- Implement old existing equipment into new systems and make it work together
- New panels with Saia PCD® and web-panels
- Communication over Modbus and M-Bus with electrical, water and steam meters, Boilers, heating pumps and ventilation systems with integrated automation



▲ Communication with Swegon HVAC Modbus



▲ Inside new panel in technical room



▲ New panel in heating central



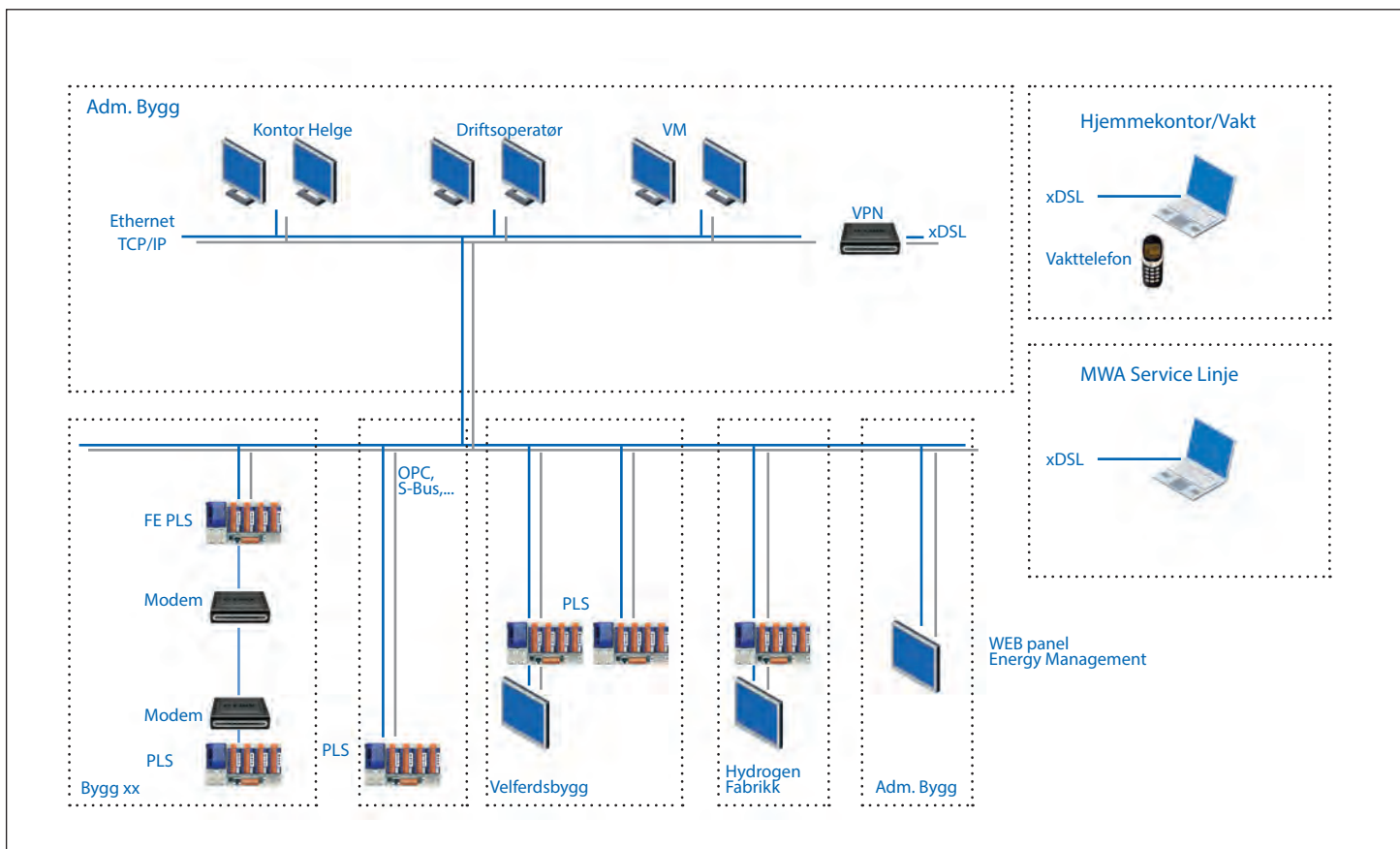

**Implementation**

- PCD2.M5540
- I/O modules
- Modbus communication with ventilation systems from Swegon
- Modbus communication with energy meters el. from Scandinavian Electric
- M-Bus communication with energy meters (water and steam) from Metrima and Endress&Hauser
- Control of heating systems based on both new field equipment and old existing equipment from different suppliers
- New panels with PCD2.M5540 and PCD7.D410VTCF

**Benefit/ Testimonial**

- One supplier of automation HVAC
- WEB solution with access from iPad
- Energy registration and trend
- Energy money refund by ENOVA to cover some of the investment
- Control of the technical installations
- MWA knowlegde of the customer, good offering solutions, knowledge of the plant and existing technical systems, right Price

▲ Heating room with hot water exchanger and steam exchanger

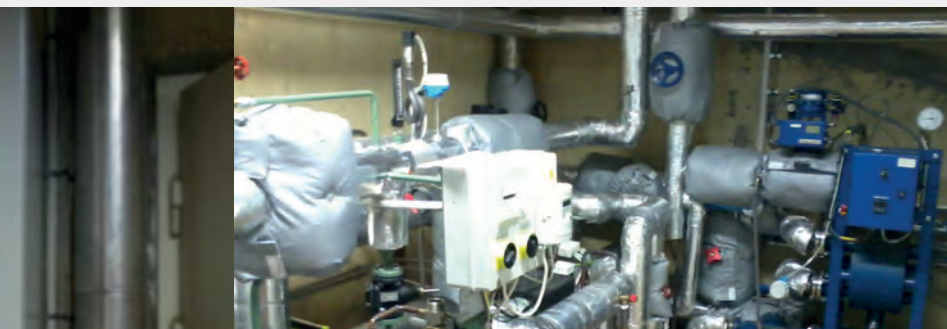

▲ Heating room with hot water exchanger and steam exchanger

**Our Partners:**

 Øraveien Industripark  
Tilknyttet Ørå-konsernet  
◀ Operator [www.oip.no](http://www.oip.no)

 Malthe Winje Automasjon AS  
◀ Systemintegrator [www.malthe-winje.no](http://www.malthe-winje.no)



## Heavac optimization with S-Monitoring

**Operator:** Parlex  
**Object:** Heavac installation  
**Country:** People's Republic of China



### Gain in efficiency through data transparency

Parlex, a manufacturer of flexible circuits, is a global company with subsidiaries in the USA, Europe and China. Simply by installing a Saia Burgess Controls Web Panel with S-Monitoring application, Parlex was able to achieve major improvements in resource efficiency. Facility Manager Edward Simpson carried out inhouse installation of the system. No programming was necessary. Due to the transparency of energy data, it was possible to identify HVAC systems as the largest consumers of electricity. The simple separation of two cooling circuits was enough to produce savings of € 100,000 per year.

### Challenges:

- A System is required which
  - Visualises consumption data
  - Can be installed easily from own employees
  - Is very flexible

### Installation:

To visualise the energy consumption, the S-Monitoring System from Saia Burgess Controls was installed:

- |                     |                          |
|---------------------|--------------------------|
| data visualisation: | Energy Manager           |
| data capture:       | 3-phase energy meter for |
| – Production        | 40 pc.                   |
| – Cooling system    | 6 pc.                    |
| – Illumination      | 3 pc.                    |
| – Air conditioning  | 1 pc.                    |

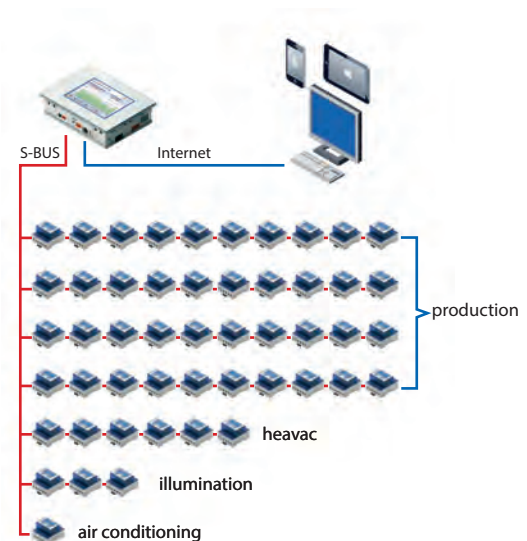

**Tree steps with a big effect**

- visualise the energy consumption
  - Installation of energy meters
  - First overview immediately possible
  - Heavac is the biggest consumer (1Mio € / year)
- analyse the situation
  - The employees prefer a higher room temperature than 21 °C
  - Clean rooms need 6 °C cooling water, offices need 11 °C cooling water
  - all rooms are cooled with 6 °C due to the same cooling circuit «
- implement the improvements
  - After the separation of the cooling circuits only the process is cooled with 6 °C water
  - The other rooms are cooled with 11 °C water
  - The room temperature is changed to 26 °C

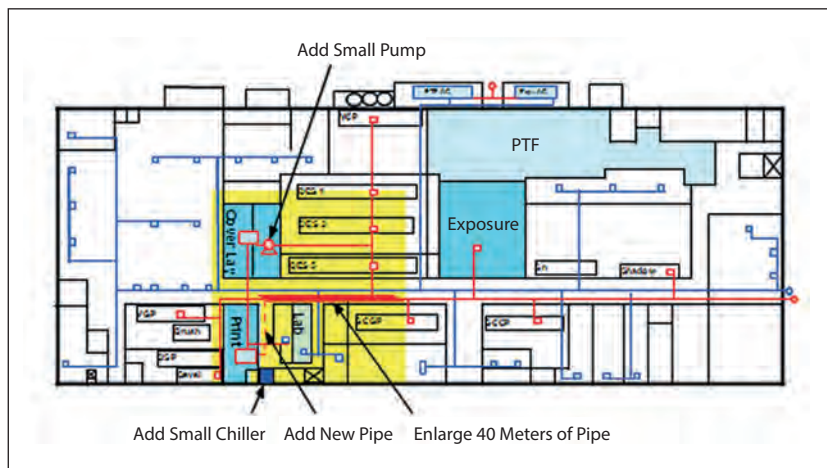

▲ Facility Manager Edward Simpson carries out in-house optimizations

“It is great to have a tool than can help me identify even a few kW of wasted energy.”

Edward Simpson

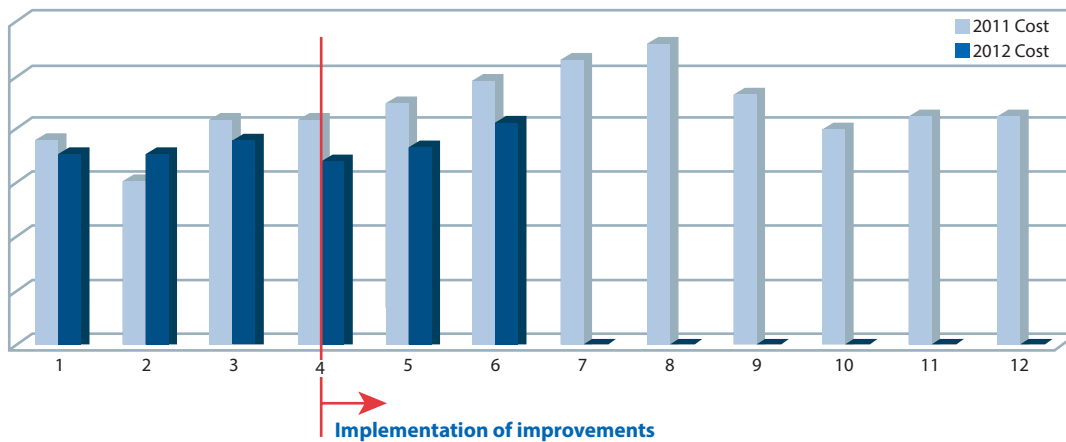

◀ Costs of electrical energy 2011 and 2012

**Revision of the improvements**

- Parlex saves over 100.000 € / year energy costs
- They had no additional costs for external consultants or integrators
- Already the awareness of the energy consumption brought the idea to ask the employees for the optimal room temperature

“The meters have given me the ability to pinpoint savings opportunities and capitalize on them.”

Edward Simpson

**Benefit of S-Monitoring in heavac applications**

- You don't have to put in a big effort
- SBC already prepared the monitoring application
- S-Monitoring is flexible and the data is directly available on automation level
- Data transparency brings awareness of energy consumption and leads automatically to optimizations

**Our Partners:**



◀ Operator & Planer [www.parlex.com](http://www.parlex.com)



## Biogas plant Cavertitz

**Operator:** Peter Hühnlein & Sohn GbR  
**Object:** Biogas plant  
**Country:** Germany

### Biogas plant IVS Elmonte in Cavertitz | Germany

Biogas plants as a contribution to CO<sub>2</sub> reduction for the future of our planet by means of renewable energy.

Solution with Saia PCD® systems including local or remote operation.

#### Facts

- CHP (Combined Heat & Power) plant with 500KW power
- 2 Fermenters
- 24-hour operation, 365 days
- Corn silage, grass silage, bio waste
- Economically dependent on EEG
- Increased requirements on the system for the avoidance of methane emissions

#### Requirements

Implementation of the control of biogas plants including the integration of CHP in various sizes. Typically 500–1000 kW.



▲ Biogas plant Cavertitz – view of the combined heat & power plant container with 500 KW installed power; Fermenter in the background



▲ Operator interface with manual emergency operation and 10 inches Saia Burgess Controls Web Panel form the basis for a comprehensive and safe operation of the plant on site

High Availability -> Manual emergency operation of the system in case of failure including emergency operation with PCD3 Smart RIOs for the fermentation process.

Remote accessibility on consumption values and alarm signals in case of failure 24H and 365 days. Fault and alarm forwarding.

Ensure high availability of the biogas plant to the operator also to meet the specified limits (methane), so reliability of the controller is a high priority; IVS set a standard for small series.

**Implementation and characteristics**

Basis is the PCD2 system, with the powerful PCD2.M5540 controller.

Expansion options are provided by the reserve on both the I/O level and the communication features (optional – for example, emailing of recorded data or reporting of faults).

Data recording is done on a PCD2.R6000 SD flash memory module with 256 MBytes data memory for 3 years. Used was the PCD3.T666 smart RIO to execute an emergency program in case of a system failure (Fermenter).

**Benefit for the operator**

PCD2 as the basis for future communication enhancements (e.g. BACnet) offers operator and owner high and long-term investment security.

Control + visualization / SCADA in one device! Thanks to the use of the "Automation Server" in the PCD2 controller a separate visualization/SCADA system can be saved. Therefore, no license costs and less maintenance.

Access anytime, from anywhere with web technology. Remote access with PC, iPad or Android OS. Data are available as a standard Excel file (CSV) for further processing by end users (farmers).

Control cabinet for the biogas plant and fermenter with PCD2 as data recorder and Web server for the PC based web operator interface and Saia Burgess Controls Micro-Browser panel PCD7.D410 for local operation on the control cabinet.

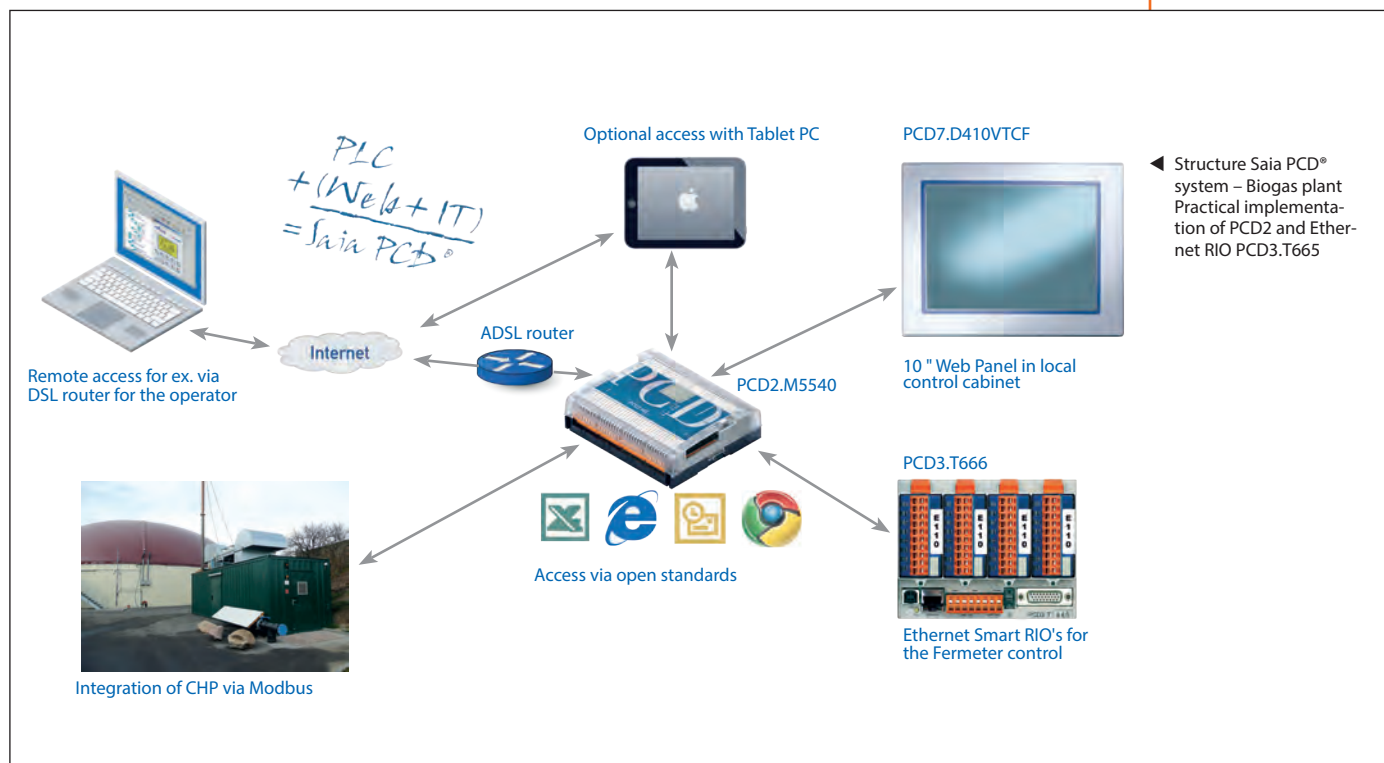

**Our Partners:**



Planer & Systemintegrator  
www.ivs-elmonta.de

# Automation reconstruction of a regional hospital in Békéscsaba



**Operator:** Hospital Békéscsaba  
**Object:** Hospital  
**Country:** Hungary

## Main information of reference story

- ▶ Main data of hospital
  - Responsibility for ~180.000 people in surrounding town and villages
  - 7x building in ~30.000 m<sup>2</sup> area
  - 14x healing department ~ 520 bed
  - 50x clinics department
  - Special diagnostic department with CT and MRI
- ▶ Main data of SI (ALTERNAVIL Ltd.)
  - Small local engineering office with 4 own employees and cooperation with a panel-builder Ltd.
  - Huge experiment in Saia PCD® planning and application (in water treatment)
  - Support background by SBC
- ▶ Especially challenge for implementer
  - The whole hospital is works in 24 hours including sterile and operation rooms too



▲ The old PCD4 system



▲ The old PCD4 system

## Old system ...

- Main data of previous building automation system
- Typical HEVAC application with climatization a heating systems and equipments
  - Special sterile system is in HEVAC application for operating rooms
  - Built at 1992-1994 by GFR Hungary
  - 9x PCD4 system ~1000 data points
  - RS-485 network (with several repeaters)
  - FESTO VIP visualization with 3x displays
  - Programmed by (later) SBA Ltd in IL

## New system ...

- Main data of new building automation system
- Application, sensors, actors and HEVAC system remains same
  - Short rebuild time: 09.07.2012 took over PCD 10.08.2012 finish
  - 9x PCD3 system ~896 built in data points
  - RS-485 network (with several repeaters)
  - VISIONx visualisation with 2 displays
  - Programmed by ALTERNAVIL Ltd in FUPLA.



▲ The new system during setting



◀ The new system during setting

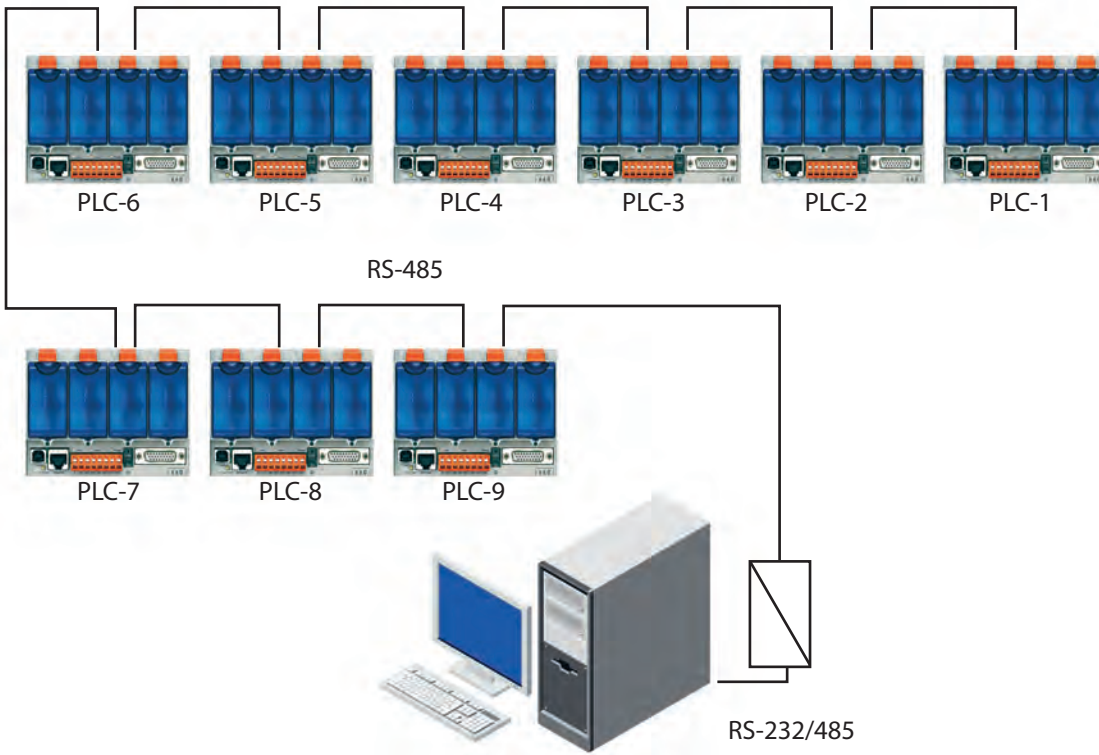
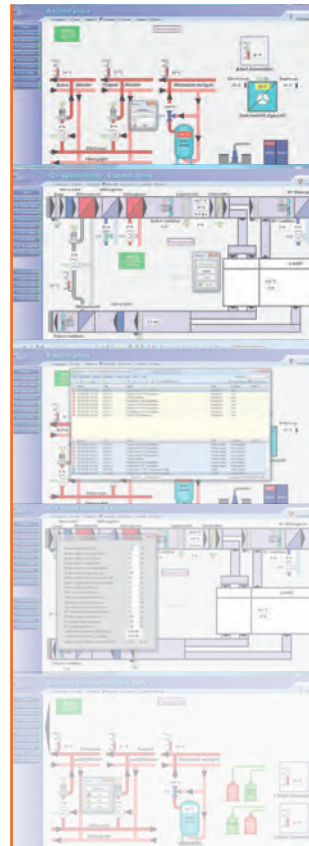

▲ System structure  
Communication network and pictures from SCADA

**Benefits...**

► Benefits for end-user

There was a Saia PCD® system which was worked more than 17 years. It was possible easy to change from an old one to a new one PCD without breakdown and to finish all of this project during 2 months.

► Benefits for SI

There is a strong and flexible delivery and support background by Saia-Burgess Controls AG and local representative behind the Systemintegrator

**Our Partners:**



◀ Planer & Systemintegrator

## Renewing and old Building/Senate Property

Operator: Senaatti Kiinteistöt  
 Object: Heavac installation  
 Country: Finland



### Senate Figures

This old historical building, built 1890 cap factory located in Turku

Senate Properties is a state enterprise

Operations are based on socially responsible business, excellent service, long-term customer relationship and partnership

Figures (building around Finland, see pictures)

- Around 12,000 buildings
- Around 6.6 million m2 of premises under management
- Property portfolio valued at EUR 5 billion
- Annual investments of EUR 300 million
- 260 staff Requirements

#### ► Customer requirements

- Flexible System with a high-level programming tool
- Flexible supervision system
- Ethernet and Web

#### ► Challenge for Saia Burgess Controls

- Installation with Profi S-I/O 25 substations, 50 room controllers and up to 5 serial-interfaces per CPU (for the future)
- Access/monitoring to all Substations via SCADA

### Sonet SCADA

Building automation systems managed from anywhere.

Easy handling with Online/On-the fly programming makes possible to simulate.

### Benefit

- Control and maintenance of any place
- Optimize and manage the energy consumption of the infrastructure
- Saia Burgess Controls PLC and SCADA program modification
- Why won?
  - Excellent documentation and drawings
  - Flexible programming tools



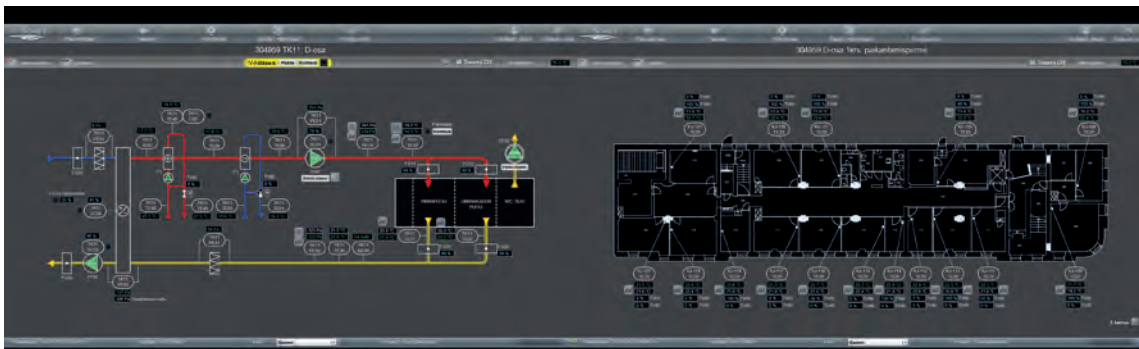

◀ SCADA System

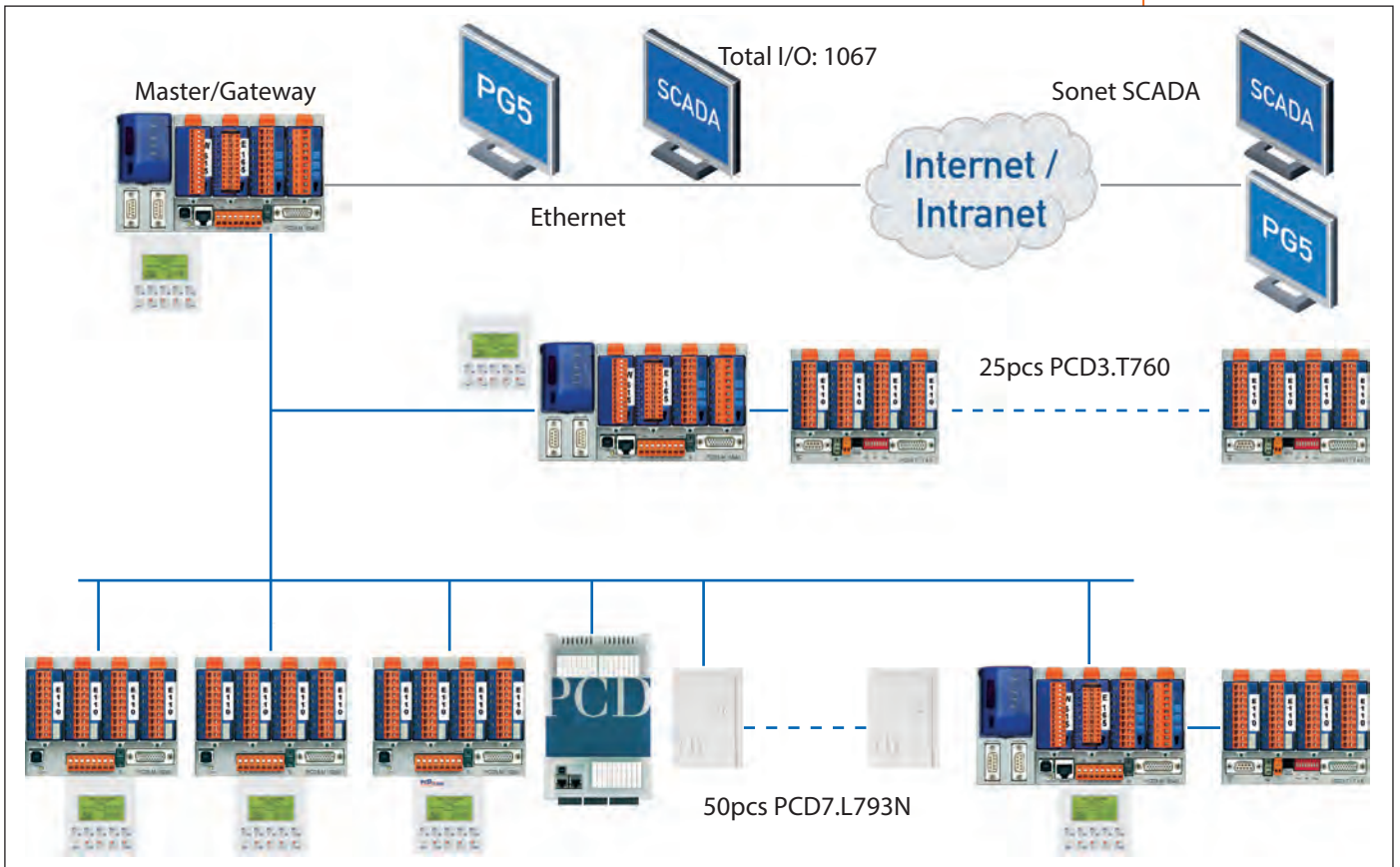

▲ Network structure

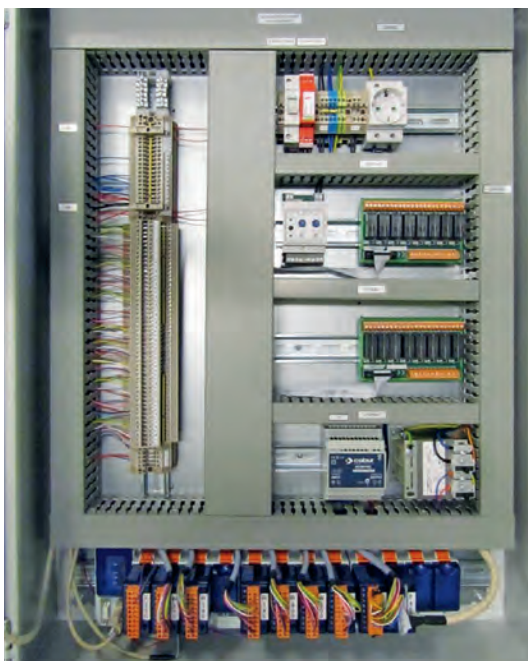

◀ Electrician cabinet

**Our Partners:**



◀ Operator  
www.senaatti.fi

**M.TUOMI OY**

◀ Systemintegrator  
www.m-tuomi.fi



## Serralves Foundation in Porto

Operator: Serralves Foundation  
 Object: Building  
 Country: Portugal

**SERRALVES**

### About Serralves Foundation

European cultural institution serving the national community, whose mission is to raise the public's awareness concerning contemporary art and the environment.

Location: Located in the Quinta de Serralves, a large property close to the center of Porto that includes a main house built in the 1930s for a Count.

Sites:

- Museum of Contemporary Art: Multi-disciplinary centre with 13.000-square-meter building, which includes 4.500 square meters of exhibition space in 14 galleries
- Park: Natural heritage site with 18 hectares of land, ideally suited for environmental education and entertainment activities
- Auditorium: Centre for reflection and debate on issues facing contemporary society

### Requirements for Building Management Renewal

Context: Renew of Building Automation with control of Heavac, illumination, electrical protections, consumption (integration of already existing analysers)

Existing System: Old controllers from Siebe, already phased out

Requirements:

- Integration on TCP/IP
- GPRS for connection to annex small sites
- Possibility to have a remote access and control of the system
- (Mandatory) To have an intervention cabinet by cabinet, without affecting the normal activity in the Serralves Foundation

Customer heard about Infocontrol solution and, after a first presentation, asked for a cooperation in the dimensioning of the solution for the tender.

**System Implementation**

- 24x PCD3.M5
- 8x PCD3.M3120
- 6x PCD3-M2330A4T5
- 5x PCD3.T660

HW I/O's: Around 2800

User Interface: SCADA (Iconics Genesis32) and Webpages

Gradual implementation, cabinet by cabinet, in order to have a zero impact in the normal activity of the Foundation.

**Benefits of Saia Burgess Controls System**

Key factors valued by Customer:

IT features: To be possible to have IP integration, with implementation of emails and web access.

GPRS: Possibility to have GPRS embedded in the PLC, having an integrated solution.

Life Cycle of SBC: The existing system, installed in 1995, was from Siebe, no longer available. So, service continuity after 15 or 20 years was important in the definition of new solution. Infocontrol had an important advantage over other integrators because we help in the dimensioning of the new solution.



▲ Cabinet in remote site (pumping station)



▲ Installation of new PCD's in an existing cabinet



**Peace of Mind**



**Our Partners:**



◀ Operator & Systemintegrator  
www.infocontrol.pt

## New extension of RenJi Hospital, PuDong District

Operator: SunCytek  
Object: Hospital  
Country: China



### Tasks and Objectives

- Requirements of the customer?
  - Reliable
  - Expandable
  - Interoperation between different systems
  - Energy – make it measurable and controllable
- Challenge for SBC China?

User was in favor of 3 common brands first and only request the conventional RS-485 DDC system to lower down the initial investment.

We have no similar project reference in China, difficult to let customer accept a new brand from their traditional mind.

Persuading customer to accept the all network type PCD configuration concepts, augrement points focused the investment and the benefits (present and future) after our SI as the winner in the first bid according to the original design (low cost solution).

### Implementation

- SBC Products – network configuration
- Saia Visi.Plus SCADA software, 1 no. 10" MB panel for Chiller plant operator
- PCD2.M5540, 9 nos, controls + integration with 3rd party system in field level
- PCD1.M2120, 33 nos, controls + integration with 3rd party system in field level
- AWD 3 phase energy meter, 87 nos, S-Bus connected to local PCD
- Measuring the energy consumption for Chiller plant equipment, energy consumption for each floor, AHU/PAU, lighting etc.

DI	DO	AI	AO	Integration with 3rd party system	Total DP for Physical + Integration
950	232	193	43	9	>3500

### Controls and monitoring

- Integration
  - CH-B1-1~3 chillers
  - HEU-B1-1~2 hot water boiler
  - Electrical system, transformer – Modbus
  - Fan coil unit – Modbus
  - VRV air-conditioner – BACnet IP
  - EBI intelligent lighting – EBI Ethernet
  - Heat pump – Modbus
  - Roof heat pump ASHP-R-1~2
  - 17/F and 18/F air-conditioners for surgery – Modbus with Siemens S200 PLC

### Owner / user

RenJi hospital had been built in 1844 (160 years). It was the first Western Medicine Hospital built in Shanghai, China.

RenJi had invested to build 3 hospitals in Shanghai city and keeping the expansion and renovation for modernization of medical treatments.

RenJi is a typical Health Care group in Shanghai Besides, it is the affiliated hospital of Jiao Tong University Medicine Faculty.

### Facts

- Usage area: 60.000 sq. meter
- 18 storey (2 storey for surgery with independent air- conditioning system), 2 besement. 2 ancillary buildings (4 storey and 5storey)

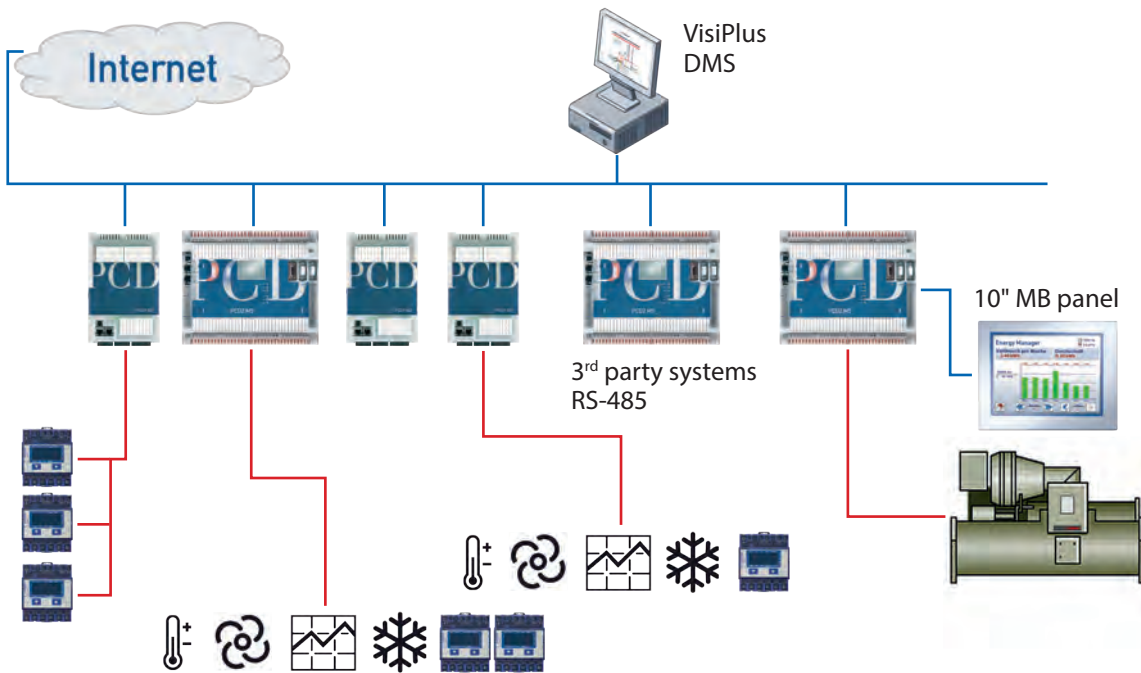

- ▶ Physical I/O points
  - AHU, PAU
  - Ventilation system
  - Potable water system, plumbing and drainage system, sump pit etc
  - Lift and escalator
  - Chilled and hot water system (additional sensor and status monitoring with emergency override controls)



▲ Energy measurement for distributed electrical cabinet and major M&E equipment

**Benefit/Testimonial**

- ▶ Benefit for the Customer
  - PLC+Web+IT offering the maximum flexibility to user and maintenance engineers, no hidden cost behind
  - Energy meter from the same manufacturer, assuring the energy data and functionality is sustainable
  - Communication for multi-protocols tailor for applications
- ▶ Why did he choose SBC – guiding customer for consideration points
  - Simple system topology including the integration with 3rd party systems
  - Integration in field level, reduce the risk and high investment compare with our competitor
  - No dedicated gateway required
  - Supporting various protocols for integration with 3rd modernization system in future
  - All network type controllers, faster system responding and the balance of investment
  - Provisional additional benefit is to link 3 hospitals in different area through the web technology without unpredictable additional cost



▲ Network type controllers for entire project and major M&E equipment

**Our Partners:**



◀ Operator  
www.renji.com

## Residential development and commercial buildings

Operator: Suurstoffi Risch Rotkreuz  
Object: Building  
Country: Switzerland

SUURSTOFFI  
RISCH ROTKREUZ



### Customer requirements and challenges for SBC

#### ► Requirements of the customer

- Open systems, no dependence
- Scalability
- Energy Data Analysis
- The analysis is performed by the high school of Lucerne

#### ► Challenges for SBC

- Higher number of M-Bus devices
- Regulation of the Anergy network
- MP-Bus Connection (60 Bus-Lines)

### Used SBC system and topology

- 11× PCD3.M5340 (Heating and cooling)
- 10× PCD3.M5340 (Powerhaus)
- 11× 5.7" MB-Panel
- 41× ALD1D5FM00A2A00
- 31× ALE3D5FM10C2A00
- 2'200 data points (HW)
- Visi.Plus
- RIO-Ethernet

### Project highlights

- Fibre optic network
- Visi.Plus over EDL portal
- Programmed with DDC Suite
- 62 ELKO electricity meters M-Bus
- 32 GWF heat meters M-Bus
- 37 GWF water meters M-Bus
- 72 SBC electricity meters M-Bus
- 400 MP-Bus data points

### Presentation of the project:

In a central location in Rotkreuz rail station arises by 2018 an integrated district with a various range of apartments for up to 1,500 residents and service areas for up to 3,000 jobs. With direct highway connection and recreation area (Lake, Rigi, golf course, etc.).

The exterior has a high biodiversity and is free of traffic. Pioneering the operation of the district works by underground storage tanks, Anergy network\* and photovoltaic plant, pollutants and CO<sub>2</sub> free.

\*Anergie network = environmental heat (outside air, geothermal and waste heat) which is distributed over a long-distance circuit

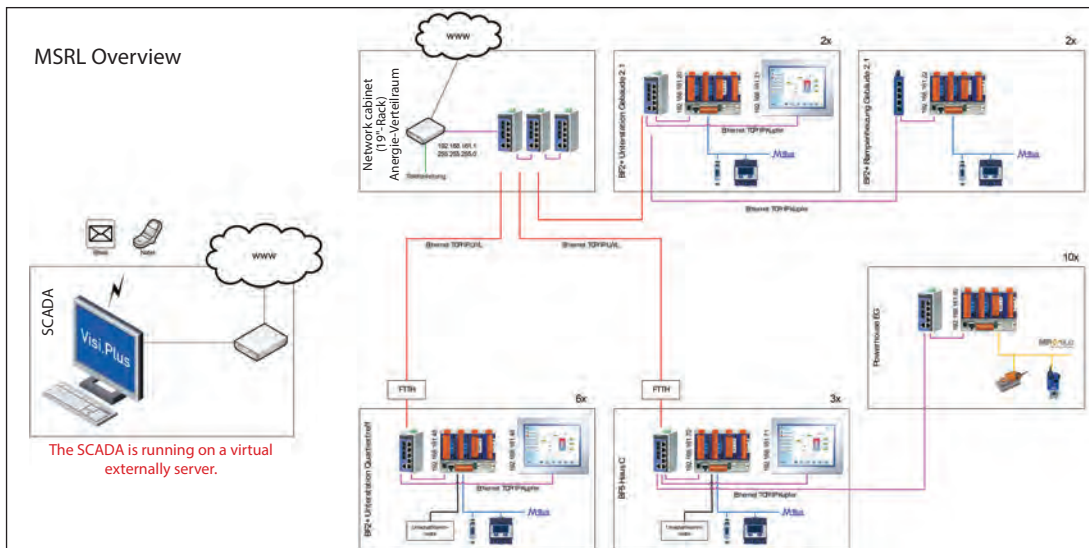

▲ Heating and cold

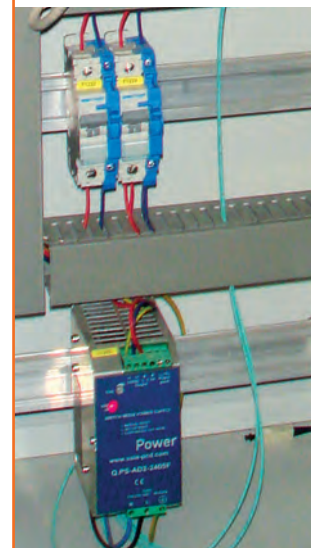

▲ PCD3 with integrated manual/emergency operation SBC M-Bus energy counter

“Thanks to the wide range of SBC we can totally be responsive to the different customer needs. The many, open and flexible interfaces enable always new exciting projects. The fast and competent support is essential and important for us. We appreciate the cooperation with SBC very much. Thanks a lot! Even with the acquisition, we can count on SBC as a reliable partner!”

Christian Bösch

Project leader Bretscher Söhne AG, Office Buchrain LU

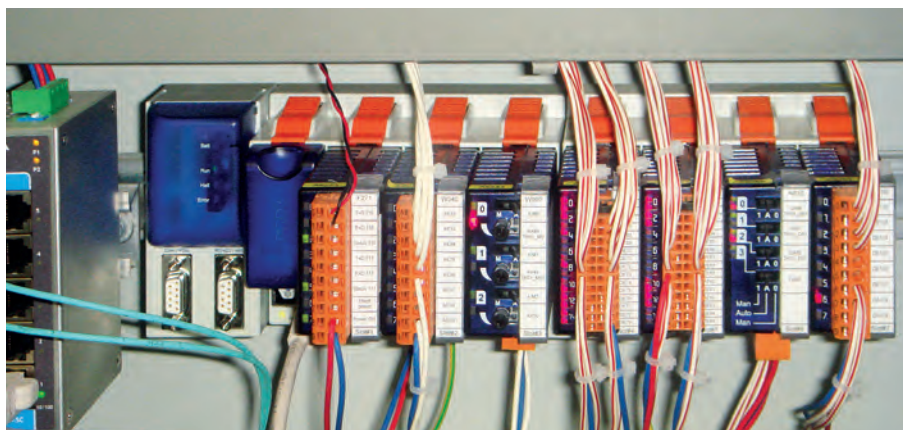

**Our Partners:**

**SUURSTOFFI RISCH ROTKREUZ** ◀ Operator  
www.suurstoffi.ch

**HANS ABICHT AG** ◀ Planer  
www.abicht.ch

**bretscher** ◀ Systemintegrator  
www.b-s-b.ch

## Zoo of future

Operator: Zoo Hannover GmbH  
 Object: Zoo  
 Country: Germany



▲ Adventure Zoo: „Yukon Bay“ and „Jungle palace“



In 1996 the reconstruction began from ordinary zoo of Hannover to the adventure zoo Hannover. The first theme park „Jungle palace“ was integrated in the existing infrastructure. It was decided to install the then newest building automation technology. Panels with web visualisation and energy monitoring make the zoo sustainable and ready for the future.

### Facts

- Founding year: 1865
- Size: 22 hectares
- 3374 animals in 229 species
- Approximately 1,5 mio. visitors per year
- Awarded as best zoo 2011

### Theme parc: Yukon Bay

- Goals: A complete overview of the infrastructure in the zoo should be combined with the operating directly on the machines. In addition a energy monitoring was demanded
- Functions: Heavac Applications, BACnet, M-Bus, connection, Operation of 3rd party systems (water treatment), Saia Burgess Controls S-Web visualisation

### Technique for the future

To meet the requirements of the customer it was decided to install Saia Burgess Controls in the infrastructure. The long life time cycle assures an expansion of the zoo without problems since 1996.

- 14x PCD2.M120 (will be upgraded to PCD2.M5xxx)
- 6x PCD3.M5xxx
- 3x PCS1.Cxxx
- Web Panel 10,4“
- ca. 20x energy meter ALE/AWD



▲ PCD3Mxxxx „Yukon Bay“



▲ Saia Burgess Controls 10,4“ Web Panel



▲ Switch cabinets „Yukon Bay“







# INDEX

## Object

### B

BLS	6
Bramac d.o.o.	12

### C

CitizenM	14
Crous of Clermont Ferrand	18
Cr System	20

### D

Dunea	22
-------	----

### G

Grand Hotel Del Mare Bordighera (IM)	24
Grand Hotel Hermitage	26
Groupe E SA	28

### H

Hilton Worldwide	32
Hospital Békéscsaba	62

### I

IDEA	30
IWB - Industrielle Werke Basel	34

### K

Kreisfeuerwehrverband Roth	36
----------------------------	----

### L

Leger des Heils Utrecht (Salvation Army)	38
Liebherr-Werk Ehingen GmbH	40

### M

MEDIA BROADCAST GmbH	44
Medicina clinic	46
Mera	48
Minin	50
MKB Fastighet AB	52

### O

OBI Česká republika, s.r.o.	54
Øra Industri Park	56

### P

Parlex	58
Peter Hühnlein & Sohn GbR	60

### S

Suurstoffi Risch Rotkreuz	70
Senaati Kiinteistöt	64
Serralves Foundation	66
SunCytek	68

### Z

Zoo Hannover GmbH	72
-------------------	----

## **Saia-Burgess Controls AG**

Bahnhofstrasse 18  
3280 Murten, Schweiz

T + 41 26 672 72 72  
F + 41 26 672 74 99

[www.saia-pcd.com](http://www.saia-pcd.com)  
[info@saia-pcd.com](mailto:info@saia-pcd.com)

## **SBC Deutschland GmbH**

Siemensstrasse 3  
63263 Neu-Isenburg, Deutschland

T + 49 61 02 20 25 0  
F + 49 61 02 20 25 200

[www.saia-pcd.de](http://www.saia-pcd.de)  
[info.de@saia-pcd.com](mailto:info.de@saia-pcd.com)

## **Saia Burgess Controls Österreich**

Rathausplatz 5  
3390 Melk, Österreich

T +43 2752 516 84 0  
F +43 2752 516 84 20

[www.saia-pcd.at](http://www.saia-pcd.at)  
[info.at@saia-pcd.com](mailto:info.at@saia-pcd.com)