

E optional Netzteil
24 VDC 2.5A
Q.PS-AD2-2402F

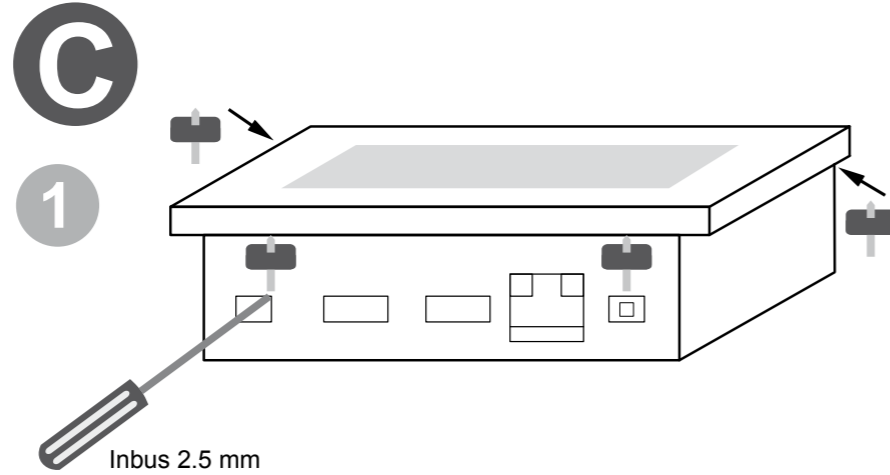

optional Ethernet

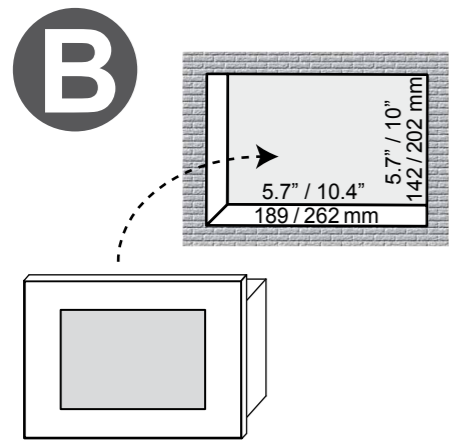
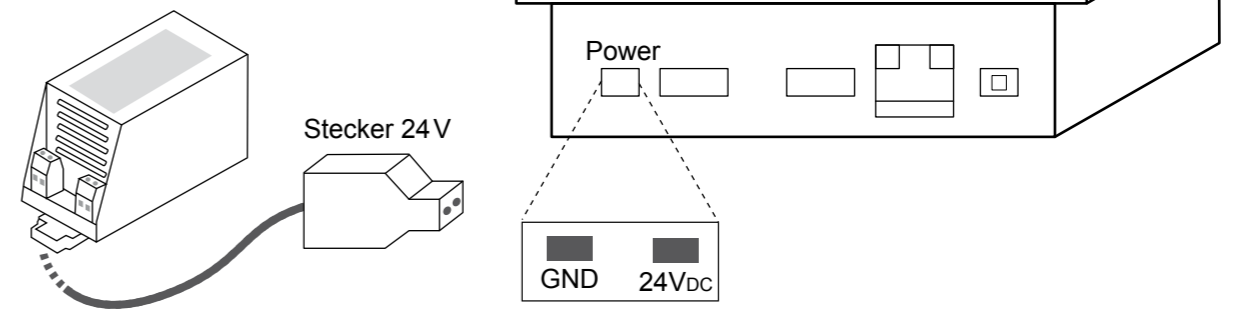
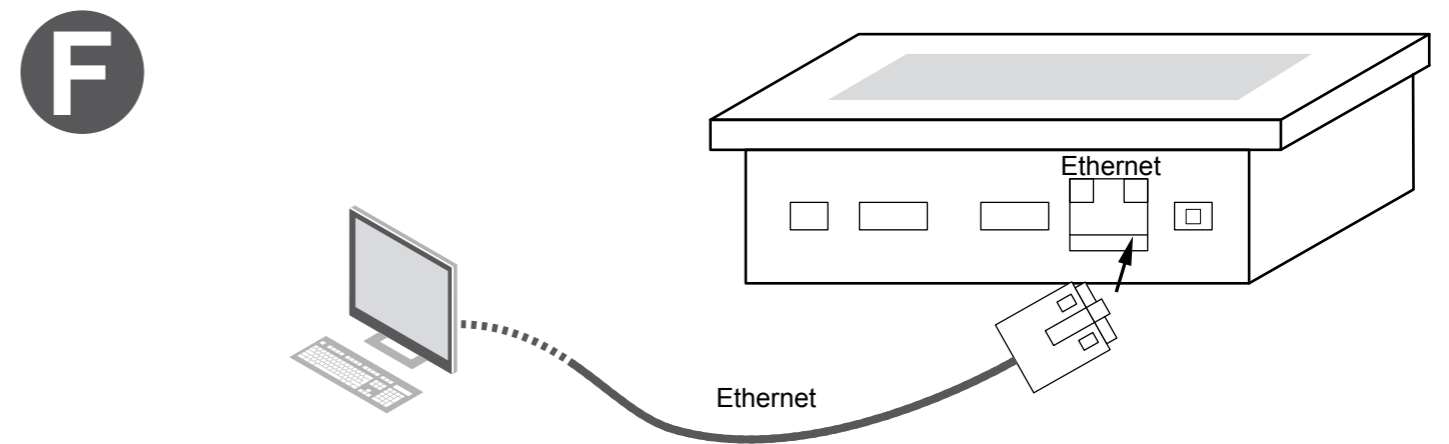

2 optional Inwall Mounting Kit
PCD7.Dxx-IWS

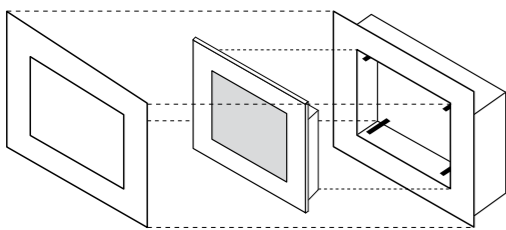

3 optional Onwall Mounting Kit
PCD7.Dxx-OWS

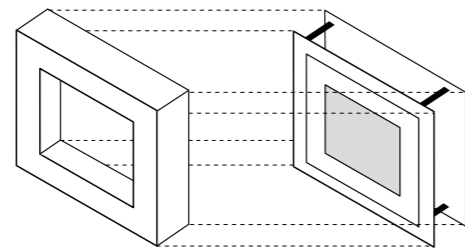

4 optional All-In-One Kit

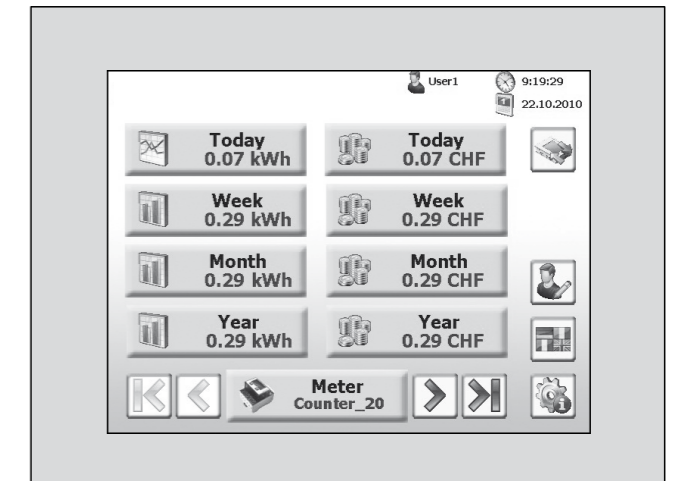
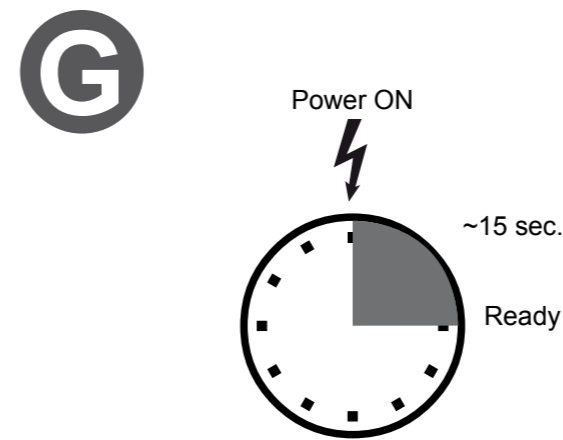
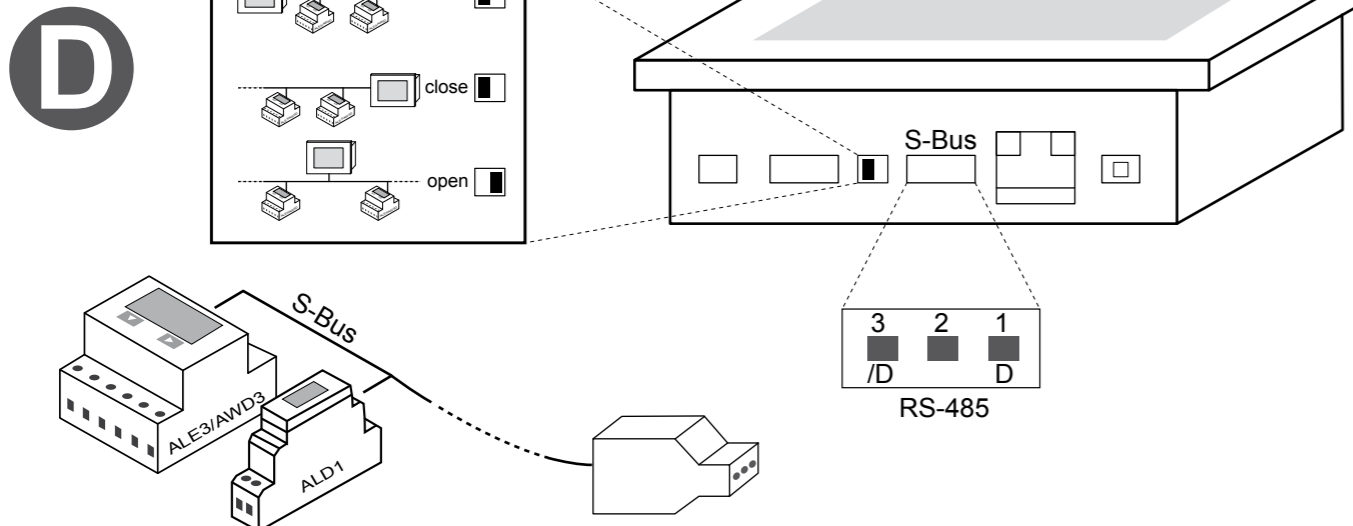
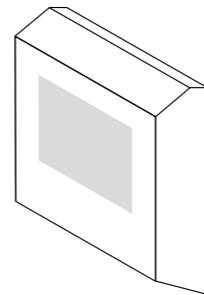

Saia-Burgess Controls AG
Bahnhofstrasse 18
3280 Murten, Switzerland
T +41 26 580 30 00
F +41 26 580 34 99
support@saia-pcd.com
www.sbc-support.com

H

Name optional

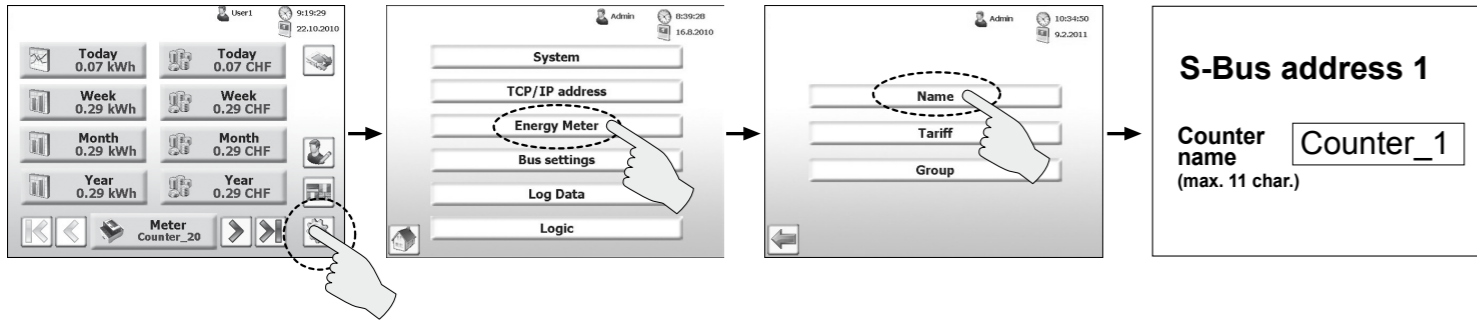
**I**

Tarif optional

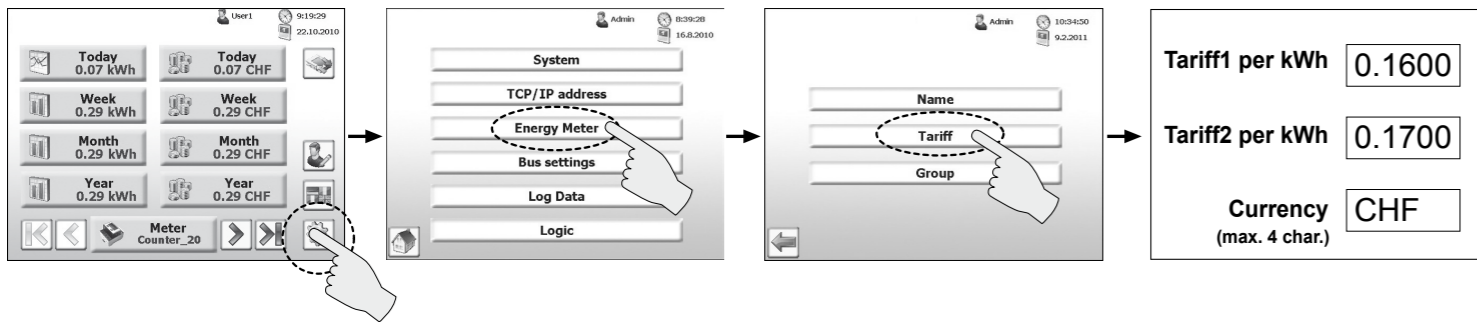
**J**

TCP / IP optional

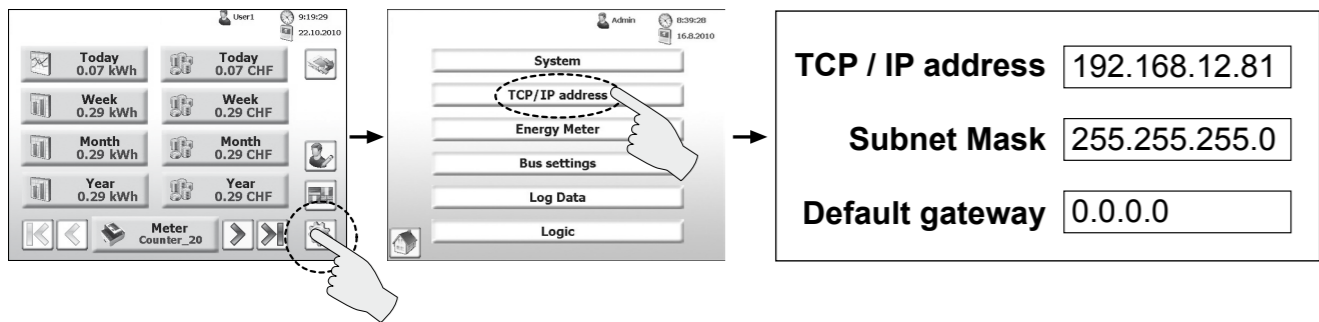
**K**

Benutzer wechseln

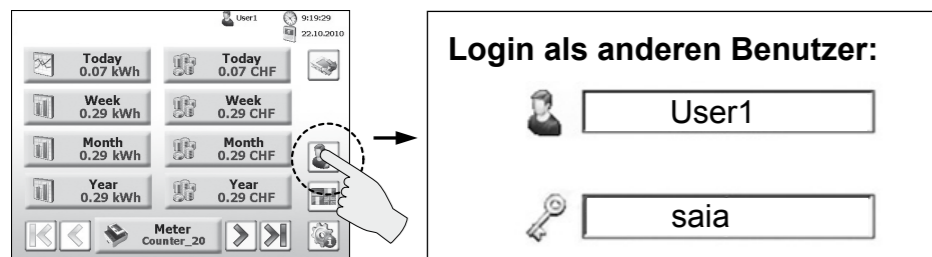
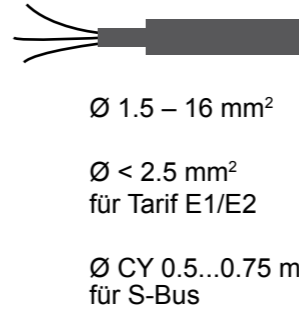
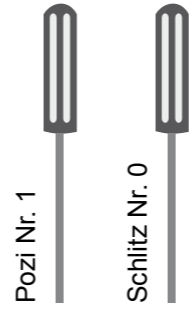
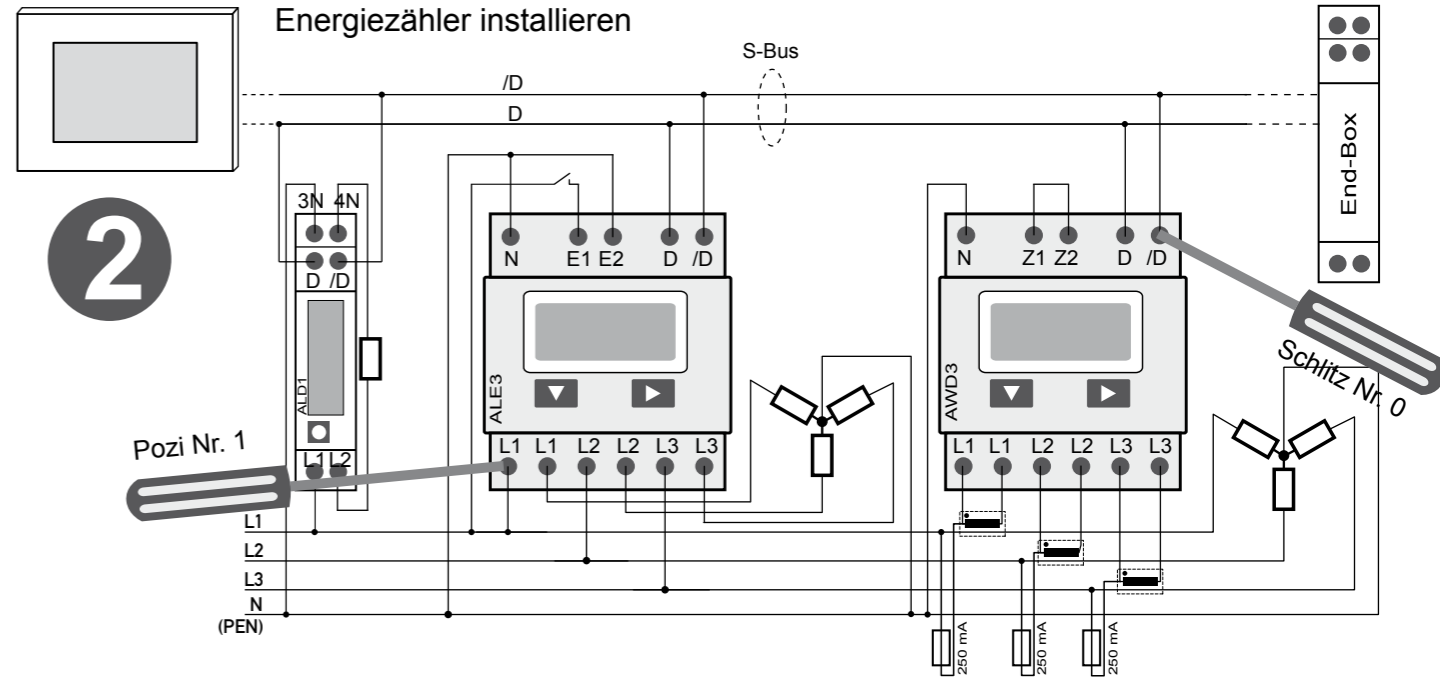
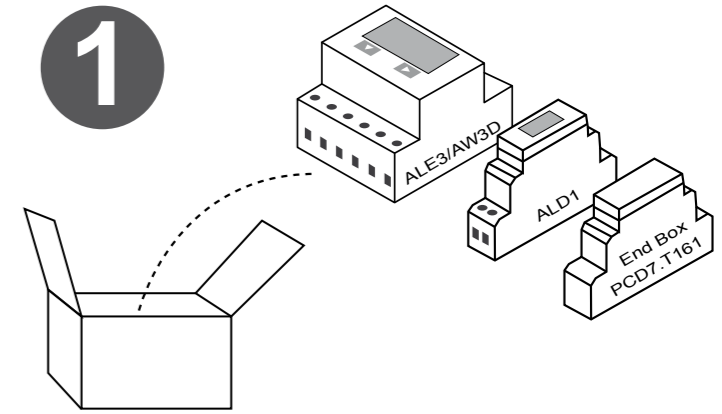
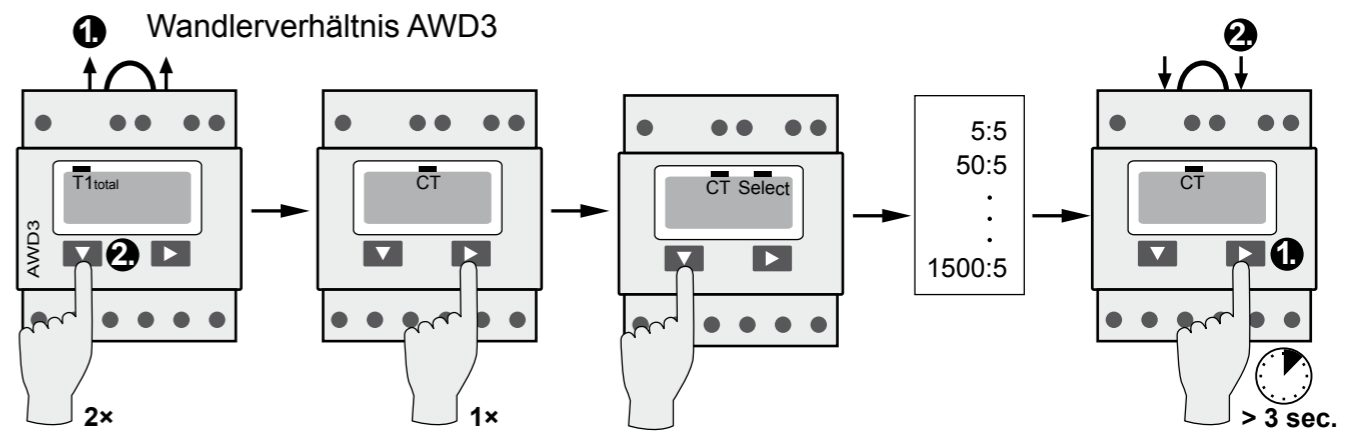
**SBC Energy Meter****Installationsanleitung****sEnergy**Ø 1.5 – 16 mm²Ø < 2.5 mm²
für Tarif E1/E2Ø CY 0.5...0.75 mm²
für S-Bus**1****2****3**

S-Bus Adresse

