











**PCD7.L645B and PCD7.L645W  
Touch screen room operator unit**

<b>0</b>	<b>Content</b>	
0.1	Document History .....	0-3
0.3	Brands and trademarks .....	0-3
<b>1</b>	<b>Overview</b>	
1.1	Home Screen .....	1-2
1.2	General .....	1-2
1.3	Basics .....	1-3
<b>2</b>	<b>Main Menus</b>	
2.1	Fan Speed .....	2-1
2.2	Lighting .....	2-2
2.3	Blinds .....	2-3
2.4	Setpoint .....	2-4
<b>3</b>	<b>Scenes</b>	
3.1	Basics .....	3-1
3.2	Controlled parameters .....	3-2
3.3	Scene menu – Setting a scene .....	3-3
3.3.1	 Occupancy .....	3-4
3.3.2	 Fan Speed .....	3-4
3.3.3	 Lighting .....	3-5
3.3.4	 Blinds .....	3-5
3.3.5	 Setpoint .....	3-6
<b>4</b>	<b>PCD7.L645 Configuration – Installation Mode</b>	
4.1	Entering Installation Mode .....	4-1
4.1.1	 Screen Sleep Timer Menu .....	4-1
4.1.2	 Lighting groups Menu .....	4-2
4.1.3	 Blinds groups Menu .....	4-2
4.1.4	 Temperature Unit Menu .....	4-3
<b>5</b>	<b>PCD7.L645 – Menus Access Rights</b>	
<b>6</b>	<b>Mounting Instructions</b>	
6.1	General .....	6-1
6.2	Mounting .....	6-2
6.2.1	Wall Support Dimensions .....	6-2
6.3	Packaging content .....	6-3
6.4	Assembly instructions .....	6-3
6.5	Connection cable .....	6-4
6.5.1	PCD7.L670 .....	6-4
<b>7</b>	<b>Type and front plate overview</b>	
<b>8</b>	<b>Customization</b>	
<b>9</b>	<b>Product Specifications</b>	
9.1	Table of the HW compatibility L60x and L61x with L645W/B from HW version and production date .....	9-2

<b>A</b>	<b>Appendix</b>	
A.1	Icons .....	A-1
A.2	Contact .....	A-2



## 0.1 Document History

Date	Version	Changes	Remarks
2012-02-17	EN01	-	First Edition
2012-03-23			Small corrections in chapter Ch06
2012-04-16	EN02	Ch. 2.2 & 2.3 Ch. 9.1 Ch. 2.2 & 2.3 Ch. 3.3.2	Note to firmware-dependent operation Hardware compatibility with PCD7.L60x and PCD7.L61x
2012-04-26			Changed the «Note to firmware-dependent operation»
2012-05-21			Changed the order of the icons
2013-02-14	EN03	Ch. 6.5.1	New numbering of the strands
2013-03-06	EN04	Ch. 5	Menus: Access Rights - new functions implemented
2013-11-14	EN05	-	New logo and new company name
2014-12-04	EN06	Ch. 2.3	New blind functions

## 0.3 Brands and trademarks

Saia PCD® and Saia PG5®  
are registered trademarks of Saia-Burgess Controls AG.

Technical modifications are based on the current state-of-the-art technology.

Saia-Burgess Controls AG, 2014 © All rights reserved.

Published in Switzerland

# 1 Overview

Thanks to its user-friendly interface, the **PCD7.L645B/W** presents an optimized ergonomics for an immediate control of the following room comfort parameter:

- Lighting
- Temperature
- Sunblinds
- Fan speed

Moreover you can easily save 4 different scenes so as to recall instantly your favorite settings to create the atmosphere fitting with the desired use of the room.

Finally, the automation of the backlight intensity, regulated by its embedded sensor depending on the room ambient luminosity, will provide you an optimal reading comfort.







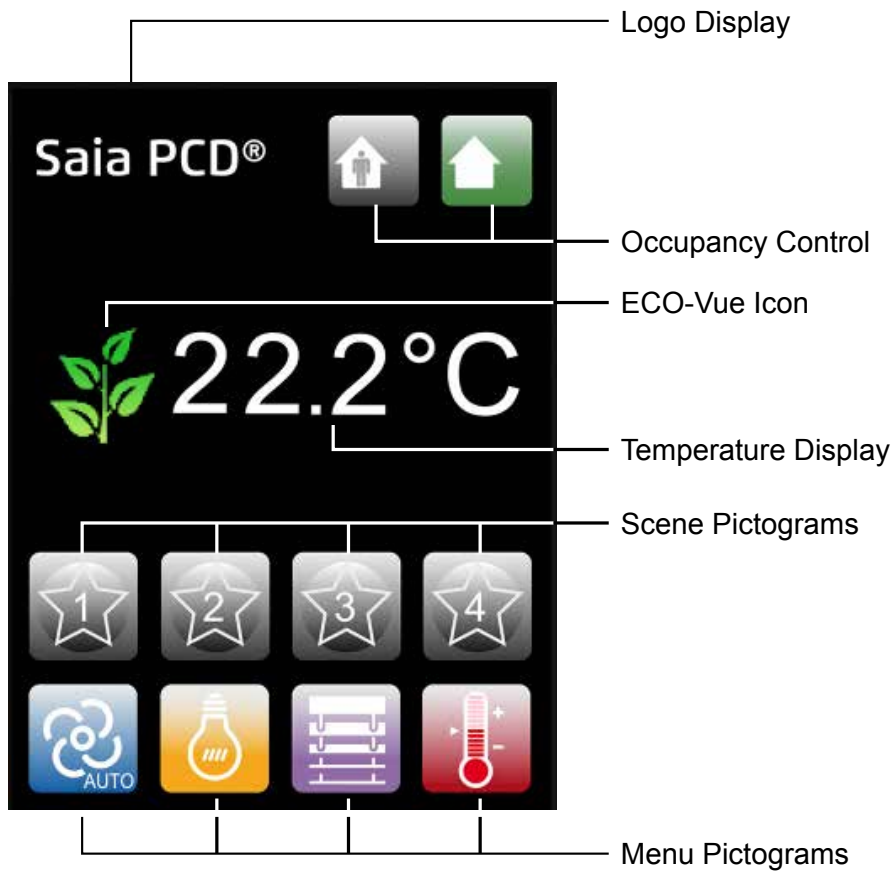



The use of a digital room control unit must be indicated in the configuration. See description of Config FBox or registers in the manual 26/854; file: «26-854\_EN\_Manual\_Modular-Room-Controller-PCD7L6xx.pdf» .

1.1 Home Screen



1.2 General

«SBC Pictogram»	Logo display
 ECO-Vue	Illustrates the energy efficiency of the current settings: the more leaves displayed, the more environmentally-friendly the settings are.
	Ambient temperature display
 Occupancy	Applies suitable room settings to optimize energy management depending on whether the room is occupied (for example blinds open, lights on...) or unoccupied (for example blinds closed, lights off ...)
 Scenario	Choose a scenario

 <p>Fan speed</p>	<p>Fan speed status display - Enter fan speed menu</p>
 <p>Lighting</p>	<p>Enter lighting menu</p>
 <p>Blind</p>	<p>Enter blind menu</p>
 <p>Setpoint</p>	<p>Temperature setpoint display - Enter setpoint menu</p>

### 1.3 Basics

All menus are entered by tapping the matching pictogram.

When entering a menu, only the matching pictogram stays colored, the inactive ones being grayed out.

Colored pictograms stand for enabled or active functions while grayed out pictogram illustrates disabled or inactive functions.



Colored pictogram ↔ enabled or active function



Grayed out pictogram ↔ disabled or inactive Pictogram

To come back from a selected menu to the home screen, tap again the actual menu pictogram.

The current occupancy, fan speed and setpoint settings are displayed on the home screen.

## 2 Main Menus



You might not see some of the menu pictograms listed hereunder if the building manager chose not to propose them.

In that case, you can't access the associated menu (Please contact your building manager for more information).

2

### 2.1 Fan Speed



When you tap the fan speed pictogram, the screen displays the fan speed menu.

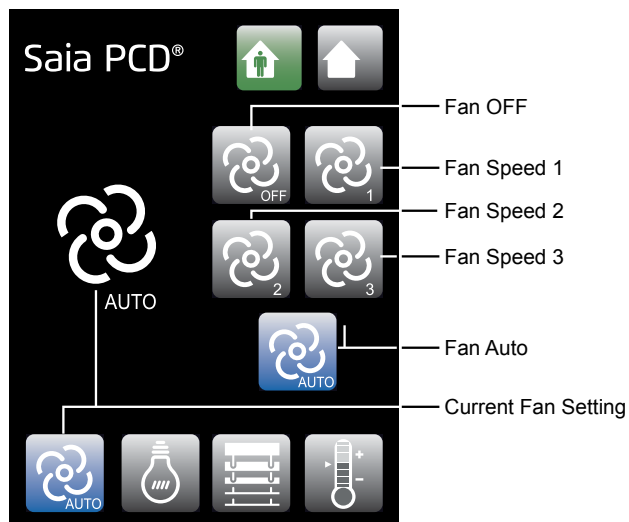

You can choose to set the fan at the speed you want (**Off**, **1**, **2**, or **3**) or to follow the automatic setting (**Auto**) which adjusts the fan speed depending on the gap between ambient and desired temperature.

Once back to the Home Screen, your chosen setting is stored until next modification.



## 2.2 Lighting



2

When you tap the lighting pictogram, the screen displays the lighting menu.

This menu allows you to adjust independently the intensity of the different lighting groups (up to 4 depending on the configuration).

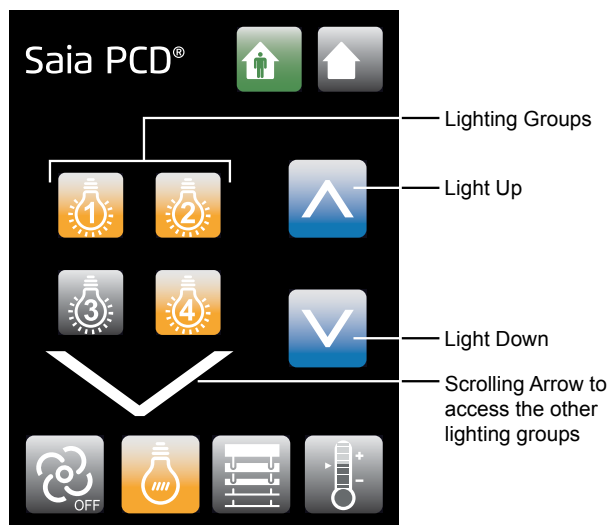

Tap the pictograms matching the lighting groups you want to set.

You can select as many groups as you want at the same time. Selected light groups are shown colored while inactive ones are grayed out.

Adjust the luminosity to your liking by tapping **Light Up/ Light Down** to switch the lights on/off.

*Only available with dimming modules:*

*If you use dimming lamps, a longer push on Light Up/ Light Down increases/decreases the luminosity.*

Once back to the home screen, your settings are stored until next modification.



Room controller with firmware versions up to SV2.01, can control only light and blind groups 3 and 4.

Group 1 and 2 may be controlled only starting with the firmware version SV2.11.

See the FAQ post on [www.saia-support.com](http://www.saia-support.com).

## 2.3 Blinds



2

When you tap the blind pictogram, the screen displays the blind menu.

This menu allows you to adjust separately the position of each group of blinds (up to 4 groups depending on the configuration).

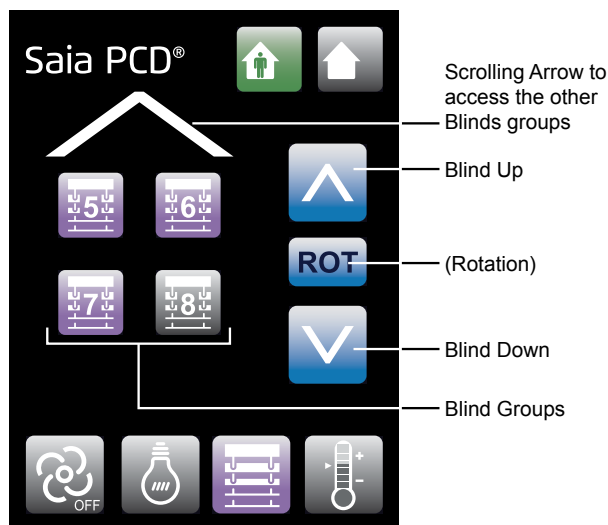

Tap the pictograms matching the blind groups you want to set.

You can select as many groups as you want. Selected blind groups are shown colored while inactive ones are grayed out.

### Position

Tap Blind Up/ Blind Down to open/ close the selected blinds.

Tap Blind Up/ Blind Down to stop the action otherwise it ends when completely open or close.

### Rotation (Starting with FW version SV2.13 of the controller)

Keeping the Rotation pictogram pushed will make the strips revolve until release. If you do it again, then the strips rotate backwards.

Once back to the home screen, your settings are stored until next modification.

## 2.4 Setpoint



2

The aim of the setpoint menu is to adjust the temperature setpoint.

When you tap the setpoint pictogram, the screen displays the setpoint menu.

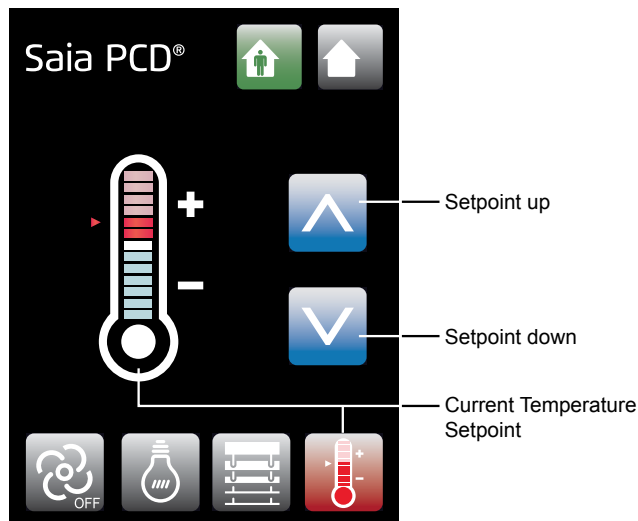

In this menu you can increase or decrease the **Current Temperature Setpoint** by tapping **Setpoint Up / Setpoint Down** ( $\pm 6$  steps from the predefined setpoint).

The step size is stored in the room controller configuration. See description of Config FBox or registers (reg. 104) in the Modular-Room-controller Manual.

**!** *The midpoint corresponds to the temperature setpoint defined by the building manager.*

Once back to the home screen, your setting is stored until next modification.

## 3 Scenes

### 3.1 Basics

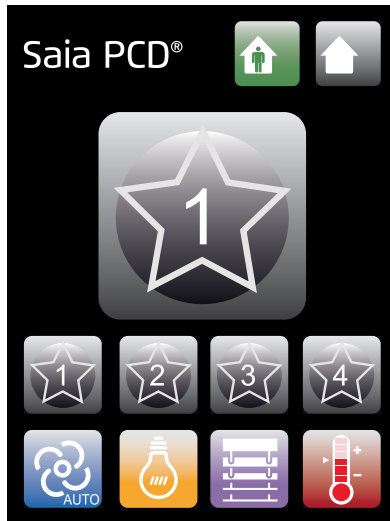

3

Up to 4 different scenes can be stored to easily recall your favorite settings.

You can call the scene of your choice simply by tapping the matching scene pictogram. The pictogram above briefly appears to confirm you the scene has been chosen.



The scene pictogram might not appear. Nevertheless you can still enter the scene menu pressing the pictogram position for 3 seconds.

### 3.2 Controlled parameters

A scene can control the following parameters:



Occupancy



Fan speed



Lighting



Blinds



Setpoint

3

Nevertheless it is totally up to you to decide which parameters you want to control from the scene. Parameters controlled by the scene are then coloured while independent ones are grayed out.

### 3.3 Scene menu – Setting a scene

You can enter scene menu by keeping the scene pictogram pressed until scene menu appears.

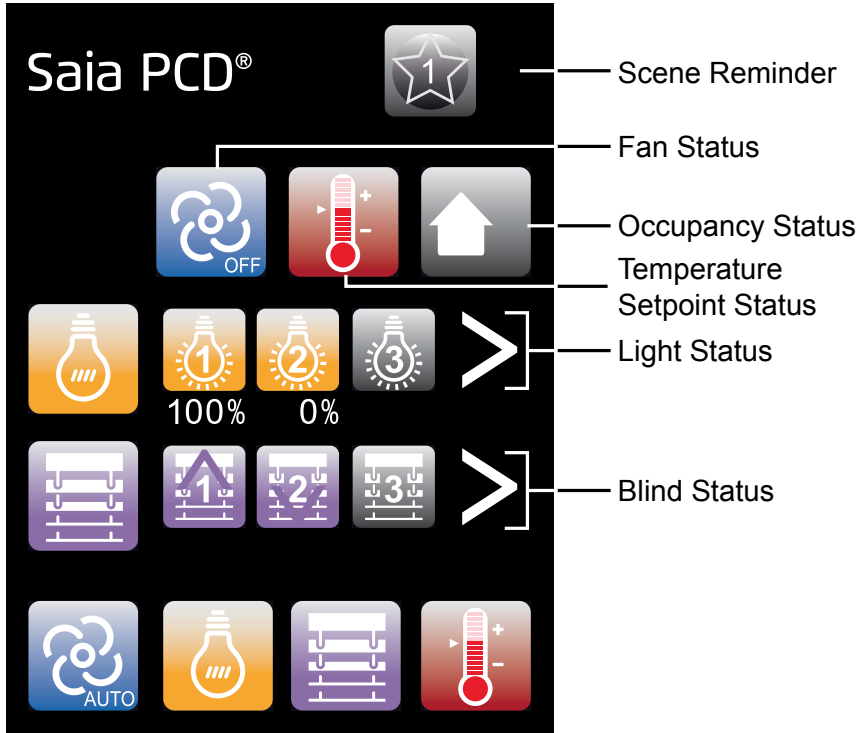

You can then adjust the different setting parameter. The parameters are automatically stored to the last value.



Tapping the bottom comfort parameters pictograms will lead you to the current setting menu i.e. out of the scene menu

### 3.3.1 Occupancy

You can choose the occupancy setting by tapping on **Occupancy Status** pictogram.

The values are then scrolling following the sequence opposite.

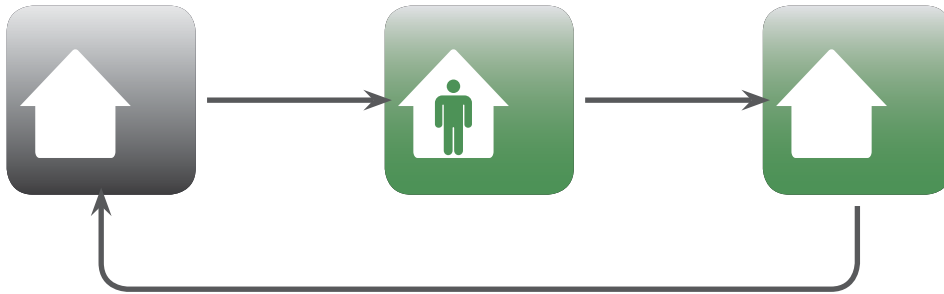

3

### 3.3.2 Fan Speed

You can choose the fan speed you want by tapping the **Fan Status** pictogram.

The values are then scrolling following the sequence opposite  
(see *Menu → Fan speed for more information*).

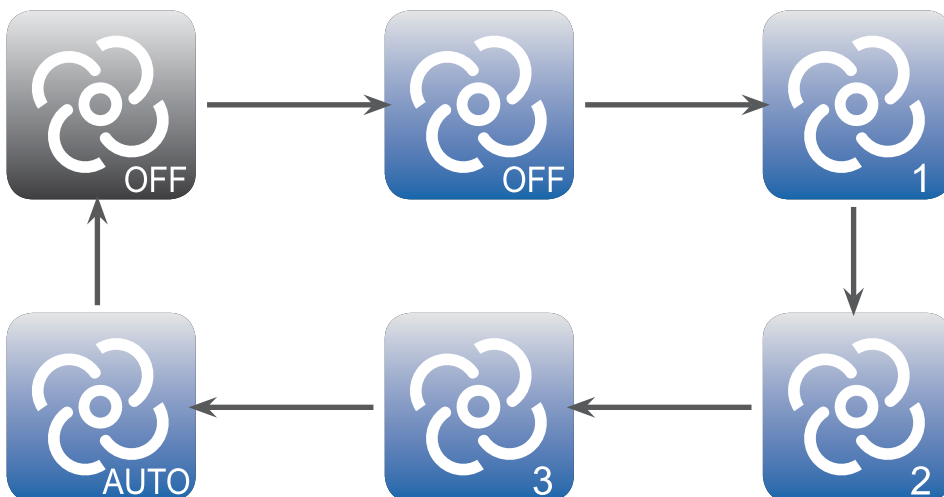

### 3.3.3 Lighting

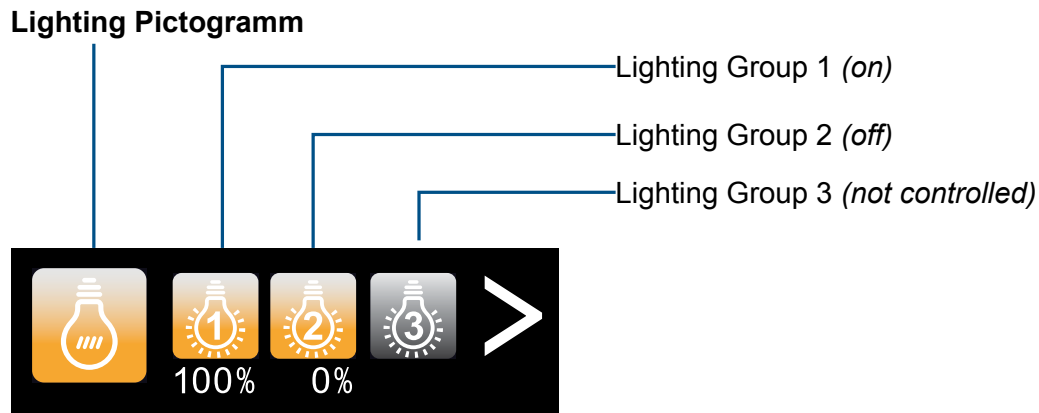

3

The **Lighting Pictogram** allows you to enable or disable lighting control.

Use the scroll arrow to access the other lighting groups if necessary (available lighting groups depend on the building settings).

You can then set each group of light to OFF (0%), ON (100%) or not controlled (Grayed out) by tapping the matching **Lighting Group** pictogram.

### 3.3.4 Blinds

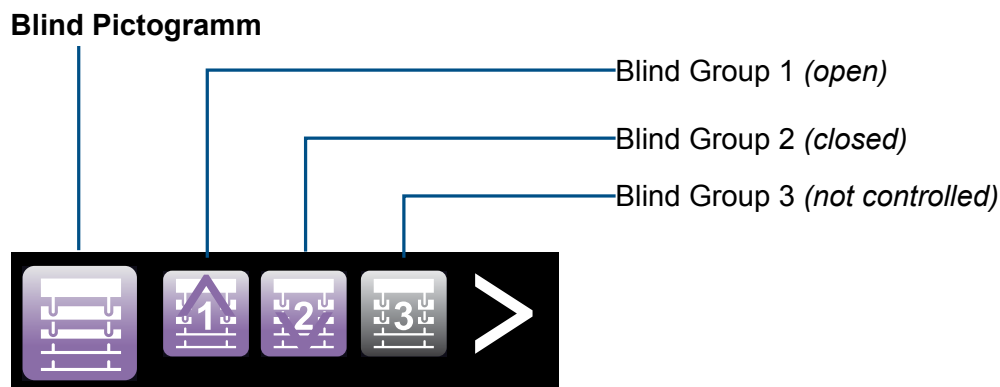

The **Blind Pictogram** allows you to enable or disable blind control.

Use the scroll arrow to access the other blind groups if necessary (available blind groups depend on the building settings).

You can then set each group of blinds to open (↑), closed (↓) or not controlled (grayed out) by tapping the matching **Blind Group** pictogram.



### 3.3.5 Setpoint

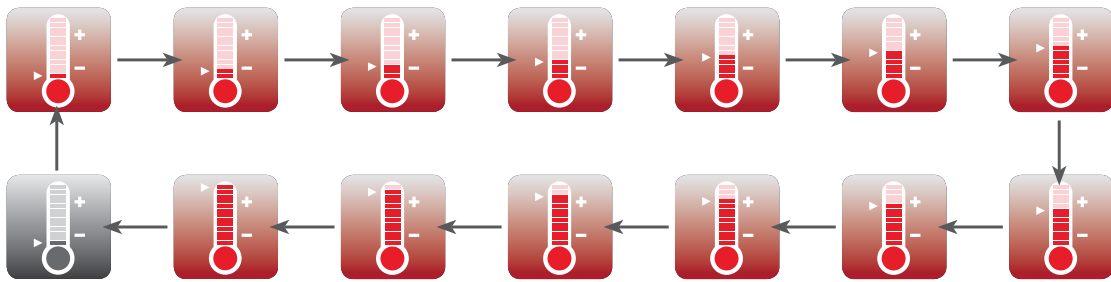

3

You can change the temperature setpoint by tapping the **Temperature Setpoint Status** pictogram.

The values are then scrolling following the sequence opposite (*see Menu → Setpoint for more information*).

## 4 PCD7.L645 Configuration – Installation Mode

The Installation Mode allows you to define the number of lighting and blinds group connected to your controller and to choose the unit of the temperature display as well as defining the screen standby delay.

4

### 4.1 Entering Installation Mode

1. Keep the Saia PCD® logo pictogram pressed until the Password Screen appears.
2. Dial the Installation Mode password (9995) and tap «Validation».
3. You are now navigating in the Installation Menus.
4. Tapping on the Menu pictogram makes the menu cycle from the Screen Sleep Timer Menu to the Temperature Unit Menu as shown blow.

#### 4.1.1 Screen Sleep Timer Menu



With the screen sleep timer you can set a time duration for screen turns off after a last action.

The screen sleep timer can be set by entering the numbers of minutes (maximum 10 minutes) and stored when tapping «ENT».

The sleep timer can be disabled by tapping 0 and «ENT»

#### 4.1.2 Lighting groups Menu

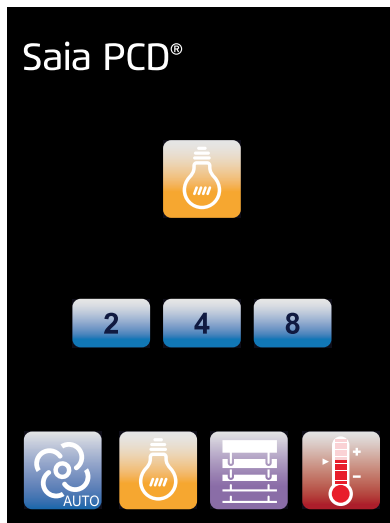

You can choose how many lighting groups you want to set by tapping the matching pictogram.

**4**

2 groups



4 groups



8 groups



In «Installation Menus» the selected setting is showed brighter.

#### 4.1.3 Blinds groups Menu

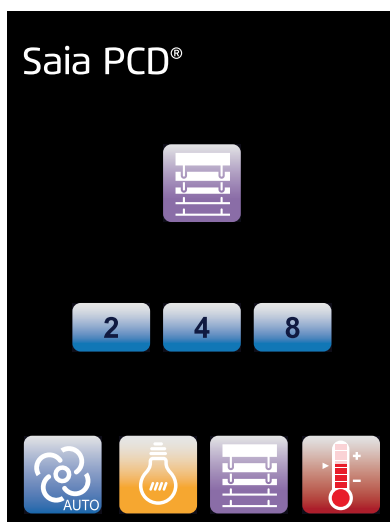

You can choose how many blinds groups you want to set by tapping the matching pictogram.

2 groups



4 groups



8 groups



In «Installation Menus» the selected setting is showed brighter.

#### 4.1.4 Temperature Unit Menu



Celsius degrees

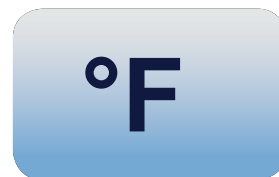

Fahrenheit degrees

4

You can set the temperature visual display unit by tapping the matching pictogram.



In «Installation Menus» the selected setting is showed brighter.

## 5 PCD7.L645 – Menu Access Rights

The integrator can choose to forbid access to any menu (Occupancy – Fan speed – Lighting – Blinds – Temperature) :

There are two ways to perform this:

1. Configuration via the FBox “L60x-1 HVAC configuration” via “Display on the LCD display”  
--> See chapter 3.3.1.1 in the manual (27/608), room controller PCD7.L60x-1

First hexadecimal digit				
	Configuration by regulator activ	Fixed to 0 (Reserve for future development)	Only for PCD7.L644	Lighting commands enabled
0				
1				x
8	x			
9	x			x

5

Second hexadecimal digit				
	Shading commands enabled	Presence button activated	Fan speed setting	Setpoint adjustment
0				
1				x
2			x	
3			x	x
4		x		
5		x		x
6		x	x	
7		x	x	x
8	x			
9	x			x
A	x		x	
B	x		x	x
C	x	x		
D	x	x		x
E	x	x	x	
F	x	x	x	x

2. If the first hexadecimal digit is written with a value of 0 or 1 on the “Display on the display” during the configuration, it is also possible to deny access to the menus directly on the PCD7.L645:
  1. Keep the matching pictogram pressed until the password screen become visible
  2. Enter the password (9995)
  3. The pictogram disappears: the end user can't enter the matching menu.

Allowing access to a forbidden menu follows the same procedure:

1. Keep the pictogram position pressed until the password screen become visible
2. Enter the password (9995)
3. The pictogram reappears.

## 6 Mounting Instructions

### 6.1 General

- The digital room control unit can only be used to control room in dry, closed rooms. The maximum permissible relative humidity is 95 %, non-condensing.
- Precise temperature measurement is subject to certain requirements as to the positioning of the room operator units.

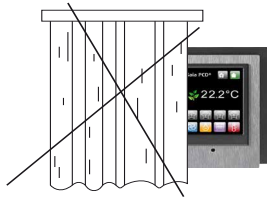

Avoid direct exposure to sunlight or light from powerful lamps.

6

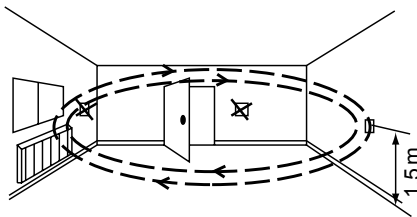

Do not install next to windows and doors because of draughts.



Do not install next to heat sources such as heaters, refrigerators, lamps etc.

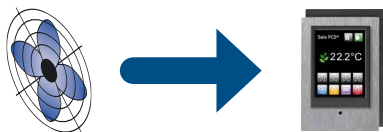

Do not fit the compact room controller on places where airflow through the direct air blowing of a VAV or Ventilation System or

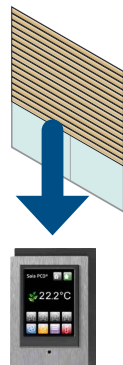

through a downwind of cold air above the compact room controller exist.

**!** Avoid other temperature perturbation on the device

## 6.2 Mounting

The PCD7.L645 can be mounted directly on the wall or screwed on an electrical junction box (not included)

### 6.2.1 Wall Support Dimensions

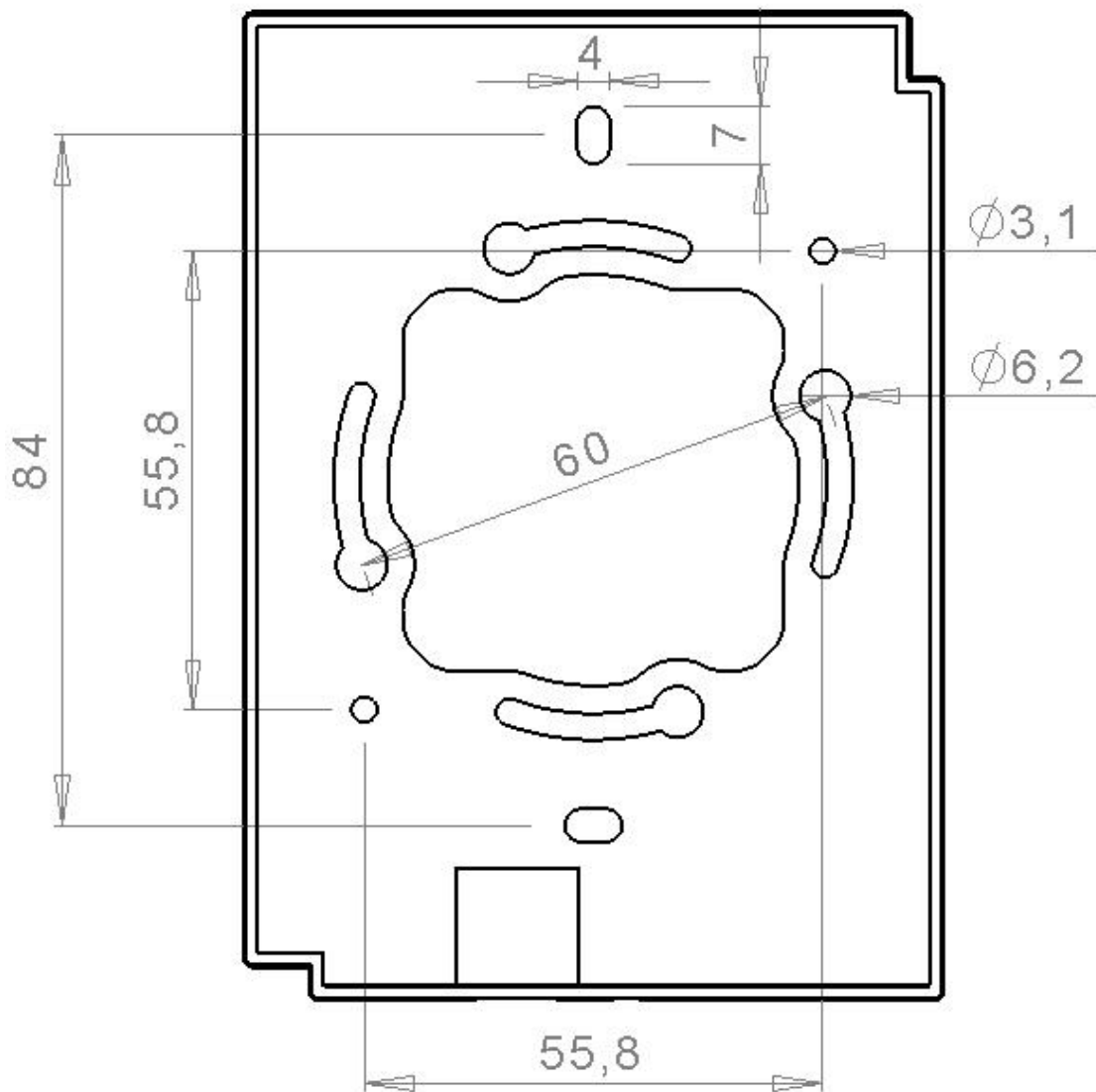

Units in [mm]



**6.3 Packaging content**

- ◆ PCD7.L645 casing
- ◆ PCD7.L645 base
- ◆ 2 front plates : brushed aluminum style and glossy black (only on PCD7.L645B) or glossy white (only on PCD7.L645W)

**6.4 Assembly instructions**

Installing the base	Installing the casing	Installing the front plate
<ul style="list-style-type: none"> <li>◆ Remove the screw from the base</li> <li>◆ Position the base on the electrical junction box</li> <li>◆ Screw the base on the electrical junction box using the suitable slots</li> </ul>	<ul style="list-style-type: none"> <li>◆ Pass the RJ-9 keyed cable through the cable hole</li> <li>◆ Connect the RJ-9 cable to the PCD7.L645 casing</li> <li>◆ Fit the top of the PCD7.L645 casing on the top of its base</li> <li>◆ Slap the bottom of the PCD7.L645 casing on the base</li> <li>◆ Lock the PCD7.L645 on the base with the screw</li> </ul>	<ul style="list-style-type: none"> <li>◆ Remove the back release sheet from the internal side of the front plate to leave the glue layer exposed.</li> <li>◆ Slap the front plate on the PCD7.L645 casing</li> <li>◆ Remove the front release sheet from the front plate</li> </ul>

6.5 Connection cable

Interface	Terminal	Description
Serial bus	RC	<p>The connection to the room controller is done with the cable PCD7.L670 directly on the controller or the use of expansion modules for lighting and shading on the last module.</p> <p>The power cable, PCD7.L670, is prefabricated on both sides and has a length of either 10 m.</p> <p>The maximum length between the room controller and the PCD7.L645 must not exceed 10 meters.</p>

6.5.1 PCD7.L670

Preconfigured cable to connect the PCD7.L645 to room controllers or extension modules.

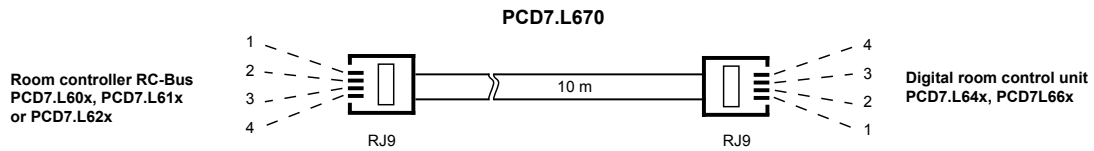

Length 10 m  
 Plug connector RJ-9 / RJ-9

To fit:  
 Room control units: PCD7.L64x, PCD7.L661 and PCD7.L663  
 Room controllers: PCD7.L60x, PCD7.L61x  
 Extension modules: PCD7.L62x and PCD7.L650

Sample of combination

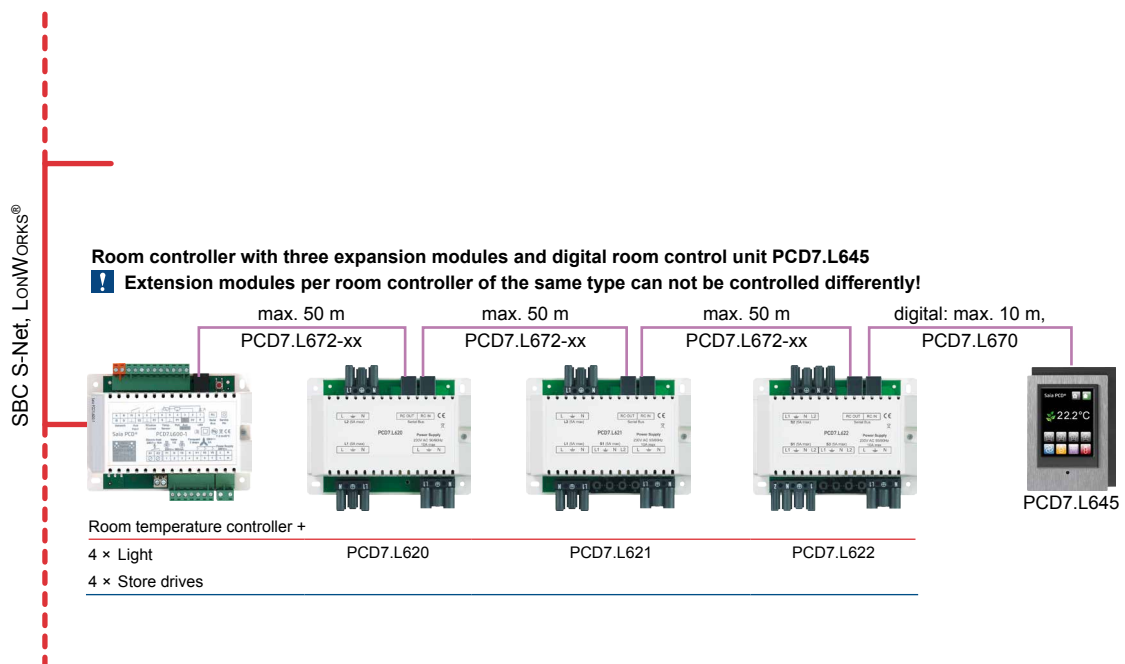

## 7 Type and front plate overview

Product Number black version	PCD7.L645B (1×black and 1×aluminium front plates are included)	
Product Number front plate	PCD7.L645-Frm01	PCD7.L645-Frm02
		
front plate color	Brushed Aluminum Style	Glossy Black
front plate Material	PMMA	ABS V0

7

Product Number white version	PCD7.L645W (1×white and 1×aluminium front plates are included)	
Product Number front plate	PCD7.L645-Frm01	PCD7.L645-Frm03
		
front plate color	Brushed Aluminum Style	Glossy White
front plate material	PMMA	ABS V0

## 8 Customization

### Front plates

On the PCD7.L645 it gives the possibility to mount interchangeable front plates (2 are included) or it is possible to build own ones according to the dimensions shown on the opposite figure.

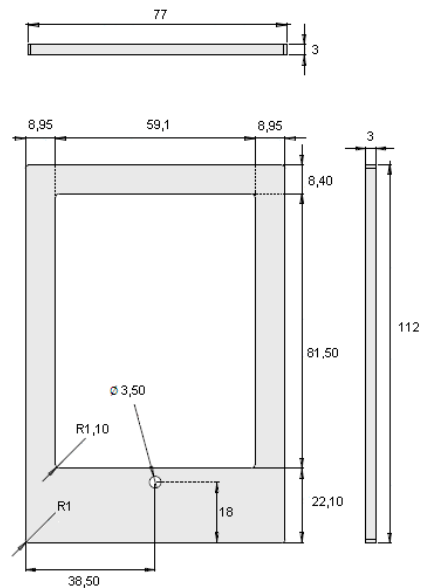

## 9 Product Specifications

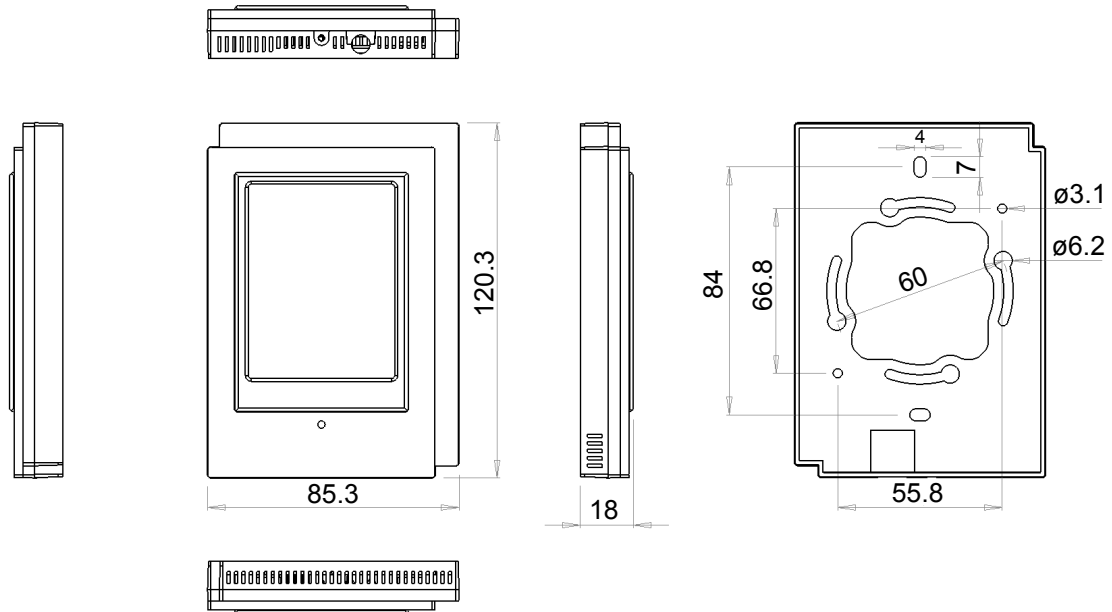

9

General	
Voltage	5 VDC +/-0.1 VDC
Power	250 mW typical

### LCD Display

Type	Full color TFT display with backlight
Resolution	240 px × 320 px (48.6 mm × 64.8 mm)
Temperature Resolution	± 0.1 °C; ± 0.1 °F

### Touchscreen

Type	Resistive
------	-----------

### Temperature Sensor

Type	10 kΩ NTC Thermistor
Range	5 °C to 36.9 °C; 41 °F to 98.4 °F
Accuracy	±0.5 °C at 25 °C; 0.90 °F at 77 °F

### Communications

Wiring	10 m maximum
Cable Type	4 conductors 7/0.16 mm (26 AWG)
Connector	RJ-9
Daisy-Chaining	No

## Table of the HW compatibility

Environmental	
Operating Temperature	5 °C to 40 °C; 41 °F to 104 °F
Storage Temperature	–20 °C to 50 °C; –4 °F to 122 °F
Relative humidity	0 to 95% Non-condensing

**Enclosure**





Material	ABS V0
Color	Graphite black
Dimensions (overall)	85.3 mm × 120.3 mm × 18 mm
Shipping Weight	0.2 kg (0.44 lbs)
Installation	Wall-mounting through mounting holes

### 9.1 Table of the HW compatibility L60x and L61x with L645W/B from HW version and production date

Product	HW-Version	Date of production
PCD7.L600	from version 1.4	2010-01-26
PCD7.L601	from version 1.3	2010-02-17
PCD7.L603	from version 1.4	2010-03-24
PCD7.L604	from version 1.2	2010-02-10
PCD7.L610	from version 1.3	2010-02-04
PCD7.L611	from version 1.5	2010-02-17
PCD7.L614	from version 1.2	2010-02-10
PCD7.L615	from version 1.3	2011-06-11
PCD7.L616	from version 1.2	2010-02-23

## A Appendix

### A.1 Icons

	<p>In manuals, this symbol refers the reader to further information in this manual or other manuals or technical information documents. As a rule there is no direct link to such documents.</p>
	<p>This symbol warns the reader of the risk to components from electrostatic discharges caused by touch. <b>Recommendation:</b> Before coming into contact with electrical components, you should at least touch the Minus of the system (cabinet or PGU connector). It is better to use a grounding wrist strap with its cable permanently attached to the Minus of the system.</p>
	<p>This sign accompanies instructions that must always be followed.</p>
	<p>Explanations beside this sign are valid only for the Saia PCD® Classic series.</p>
	<p>Explanations beside this sign are valid only for the Saia PCD® xx7 series.</p>

**A.2 Contact****Saia-Burgess Controls AG**

Bahnhofstrasse 18  
3280 Murten  
Switzerland

Phone ..... +41 26 672 72 72

Fax..... +41 26 672 74 99

Email support: ..... [support@saia-pcd.com](mailto:support@saia-pcd.com)

Supportsite: ..... [www.sbc-support.com](http://www.sbc-support.com)

SBC site: ..... [www.saia-pcd.com](http://www.saia-pcd.com)

International Representatives &

SBC Sales Companies: ..... [www.saia-pcd.com/contact](http://www.saia-pcd.com/contact)

**Postal address for returns from customers of the Swiss Sales office****Saia-Burgess Controls AG**

Service Après-Vente  
Bahnhofstrasse 18  
3280 Murten  
Switzerland

A