

PCD1.M2220-C15 E-Line CPU

0	Table of Contents	
0.1	Document Process	0-4
0.2	Trademarks	0-4
1	Graphic overview	
1.1	Go to...	1-1
2	Guidance	
2.1	Documents	2-1
2.2	Introduction	2-2
2.2.1	Connection of Saia PCD® controllers to the Internet	2-2
2.2.2	Planning an application	2-3
2.2.3	Wiring	2-4
2.2.4	Addressing the inputs and outputs (I/O)	2-5
2.3	Assembly	2-7
2.3.1	Dimensions	2-7
2.3.2	Mounting position and ambient temperature	2-7
2.3.3	Mounting on DIN rails	2-8
2.3.4	Disassembly from DIN rails	2-8
2.3.5	Slot cover for PCD2-I/O plug-in module Slot 0 and 1	2-9
2.3.6	Process slot cover	2-10
2.4	Handling PCD2 I/O modules	2-14
2.4.1	Insert module	2-14
2.4.2	Remove module	2-14
2.5	Power supply and earth concept	2-15
2.5.1	Ground symbol	2-15
2.5.2	24VDC supply	2-16
2.5.3	24VAC supply	2-17
3	CPU / processor unit	
3.1	Properties of the PCD1.M2220-C15 CPU	3-1
3.2	General technical details	3-2
3.3	Hardware version number	3-3
3.4	Firmware (COSinus update)	3-4
3.5	System memory structure	3-5
3.5.1	Memory management of the PCDs with the COSinus OS	3-5
3.5.2	Flash memory structure on PCD1.M2220-C15	3-6
3.5.3	SD card on IO slot (PCD2.R6000)	3-6
3.5.4	Flash memory modules PCD7.Rxxx for the file system	3-7
3.6	System resources	3-8
3.6.1	User program in block structure	3-8
3.6.2	Data types/value ranges	3-9
3.6.3	Resource elements	3-9
3.6.4	Data retention	3-10
3.7	LED operating states	3-11
3.8	Run/Stop button	3-12
3.9	Watchdog (relay)	3-13
3.9.1	.. as a watchdog function	3-13
3.9.2	.. as a relay output	3-15

3.10	Watchdog (software)	3-17
3.11	Program download and backup	3-18
4	RIO (Remote I/O)	
4.1	Remote expansions	4-1
5	Communication interfaces	
5.1	Using the SBC S-Bus	5-1
5.2	On-board	5-2
5.2.1	PGU (USB port) programming interface	5-2
5.2.2	Ethernet (Eth0.0/Eth0.1) port #9	5-3
5.2.3	RS-485 (port#0+1) electrically isolated (terminal block X1)	5-4
5.3	Interfaces using PCD2 plug-in modules PCD2.F2xx	5-6
5.3.1	General notes for the plug-in module PCD2.F2xxx	5-6
5.3.2	Port addresses for PCD2.F2xx on Slot 0 and/or Slot 1	5-7
5.4	Modem communication	5-8
6	Inputs and outputs	
6.1	On-board	6-1
6.1.1	Connection overview	6-2
6.1.2	Digital inputs (terminal block X10, X14, X18)	6-3
6.1.3	Analogue inputs (terminal block X10)	6-5
6.1.4	Digital output	6-9
6.2	I/O plug-in modules for Slot 0 and Slot 1	6-11
7	System cables and adapters	
7.1	System cables with I/O module connections for PCD	7-1
8	Configuration	
8.1	Requirement	8-1
8.2	General	8-2
8.3	Device Configurator	8-3
8.3.1	Execution	8-3
8.3.2	Help	8-3
8.3.3	Media mapping view	8-4
8.4	Digital inputs on-board	8-5
8.5	Analogue inputs on-board	8-6
8.6	Special function	8-8
8.6.1	Watchdog relay for monitoring or as relay output	8-8
9	Maintenance	
9.1	Maintenance-free	9-1

A Appendix

A.1	Symbols	A-1
A.1.1	Note:	A-1
A.1.2	Connection descriptions	A-1
A.2	Definition of serial interfaces	A-2
A.2.1	RS-485	A-2
A.3	Installation regulations and relay contacts	A-3
A.3.1	Installation regulations for switching extra-low voltage	A-3
A.3.2	Installation regulations for switching low voltage	A-3
A.3.3	Switching inductive loads	A-5
A.3.4	Specifications of the relay manufacturer about the dimensioning of the RC elements	A-5
A.4	Abbreviations	A-7
A.5	Glossary	A-8
A.6	Contact	A-10

0.1 Document Process

Version	Updated	Published	Comments
ENG01	2016-04-18 2016-05-10	- Chapt. 6.1.4	- New Document - Connection assignment for watchdog function
ENG02	2020-03-03	Chapt. 6.1.2	- Wiring diagram for AC-inputs changed
ENG03	2020-03-25	Chapt. 6.1.2	- Wiring diagram for AC-inputs changed again

0.2 Trademarks

Saia PCD® is a registered trademark of Saia-Burgess Controls AG.

Technical changes are subject to the latest technical developments.

Saia-Burgess Controls AG, 2020. © All rights reserved.

Published in Switzerland

1 Graphic overview

1.1 Go to...

1

The graphic overview shows some of the most important points regarding the operating instructions for the PCD1.M2220-C15.

Click the descriptive texts for the connections to jump direct to the corresponding section of the document.

The numbers separated by full stops correspond to the chapter numbers.

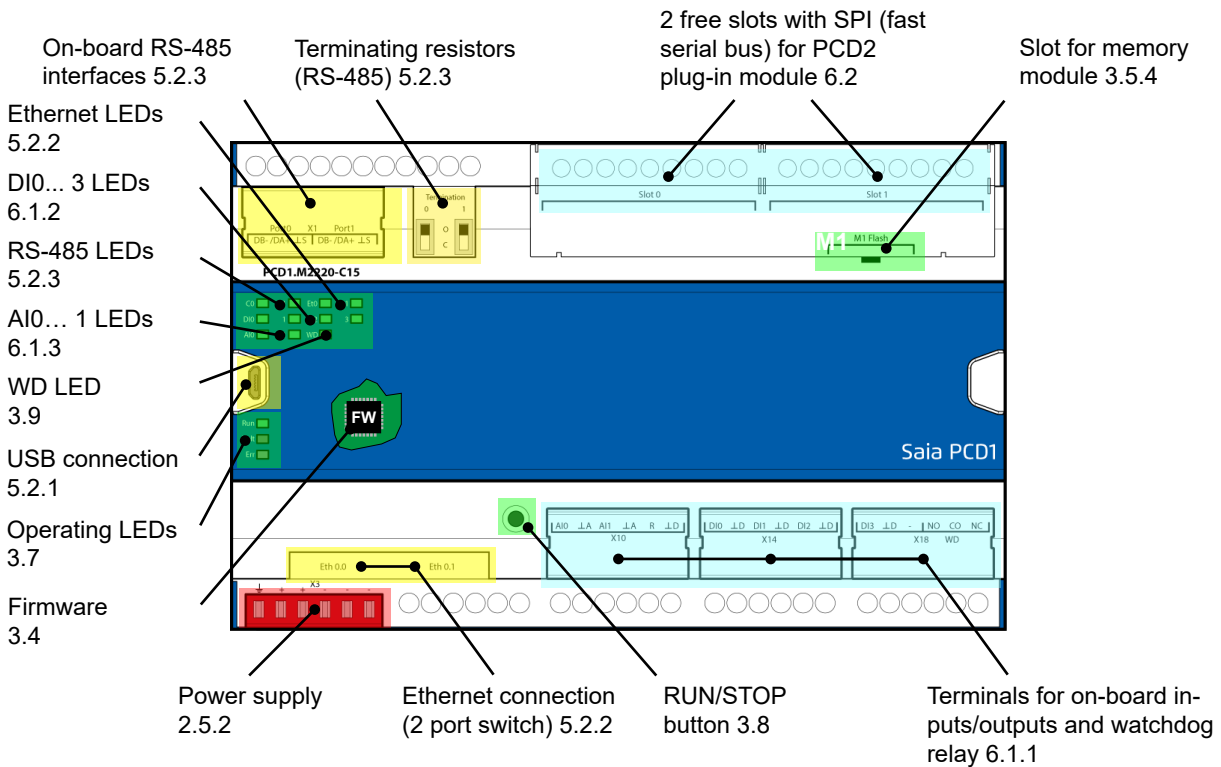

2 Guidance

2.1 Documents

Comprehensive information and manuals, flyers, etc. can be downloaded from the following websites.

Support: www.sbc-support.com

PCD homepage: www.saia-pcd.com



The screenshot shows the website interface with the 'Dokumente' menu item highlighted by a red circle. The page content includes a search bar, a navigation menu, and several sections: 'Willkommen auf der Support Seite', 'System Katalog' (with download links for German, English, French, and Italian), 'Security Upgrade für PCD Steuerungen', and 'Anschluss von PCD-Steuerungen direkt an das Internet'. A 'Neuste Änderungen' section is also visible at the bottom.

The following documents are recommended as a supplement to this manual:

Topic	Document number
System catalogue	26-215
Saia PG5 [®] programming tool	26-732
Programming in the instruction list	26-733
I/O modules	27-600
System cables and adapters	26-792
Ethernet TCP/IP	26-776
RS-485 network	26-740

2.2 Introduction

This manual describes the technical details of the PCD1.M2220-C15 components. The meanings of the symbols, abbreviations and general technical information used in this manual are listed in the appendix.

This section should help you to recognise and implement the principles for the planning and installation of controller systems with PCD1.M2220-C15 components.

Details about hardware, software, configuration, maintenance and troubleshooting are included in the relevant sections.

2.2.1 Connection of Saia PCD® controllers to the Internet



When Saia PCD controllers are connected directly to the Internet, they are also a potential target for cyber attacks. Appropriate protective measures must always be taken to ensure secure operation.

PCD controllers include simple, integrated protection features. However, secure operation on the Internet is only guaranteed using external routers with a firewall and encrypted VPN connections.

For more information, please refer to our support site:
www.sbc-support.com/security

2.2.2 Planning an application

When planning PCD1.M2220-C15 applications, the following aspect must be considered:



The internal load current taken by the I/O modules from the +5V and +V supply must not exceed the nominal supply current specified for the CPU.

2

When planning an application, we recommend the following procedure:

1. Select all the I/O modules according to the requirements.
2. Check the max. supply current for the CPU!
3. Estimate an intake of the 24V supply. Use the estimated values. The estimated values can be taken from the section on the current requirement of the PCD1 I/O modules or defined using the PG5 device configurator.



For most applications, it must be noted that the outputs represent the largest load on the 24V power supply. For 16 outputs with a load output of 0.5A each, the load is still 8A if all the outputs are switched on.

2.2.3 Wiring



2

Appropriate use
By qualified personnel only

- 230VAC power cables and data cables must be installed separately with a minimum distance of 10 cm. It is recommended to also leave space between the power and data cables in the switch cabinet.
- Digital data/bus lines and analogue data/sensor lines should be installed separately.
- It is recommended to use shielded cables for analogue data cables.
- The shielding should be earthed at the inlet to or outlet from the switch cabinet. The shielding should be as short as possible and feature a cross-section that is as large as possible. The central earthing point should be $> 10 \text{ mm}^2$ and connected to the earth cable via the shortest route.
- The shielding is normally only connected with the control cabinet on one side unless a potential equalisation with significantly lower resistance than the shielding resistance is present.
- Inductive loads that are installed in the same switch cabinet, e.g. contactor coils, must be equipped with suitable suppressors (RC elements).
- Switch cabinet components with large field strengths, e.g. transformers or frequency inverters, should be shielded with separator plates with a good earth connection.

Overvoltage protection for great distances or external cables

- When installing cables outside buildings or over great distances, suitable overvoltage protective measures must be taken. These measures are crucial, particularly for bus cables.
- For cables installed outdoors, the shielding must have a suitable power cable capacity and be earthed at both ends.
- The overvoltage conductor should be installed at the inlet of the switch cabinet.

2.2.4 Addressing the inputs and outputs (I/O)

Optical starting point for the following description

The PCD is mounted as shown below so that the text can be read from left to right.

Addressing

For Saia PCD® controllers PCD1.M2220-C15, addressing the IO slots starts from left to right. The integrated I/Os on the PLC processor boards (on-board) are assigned to the terminal blocks X10, X14, X18 and are located on the underside of the PCD.

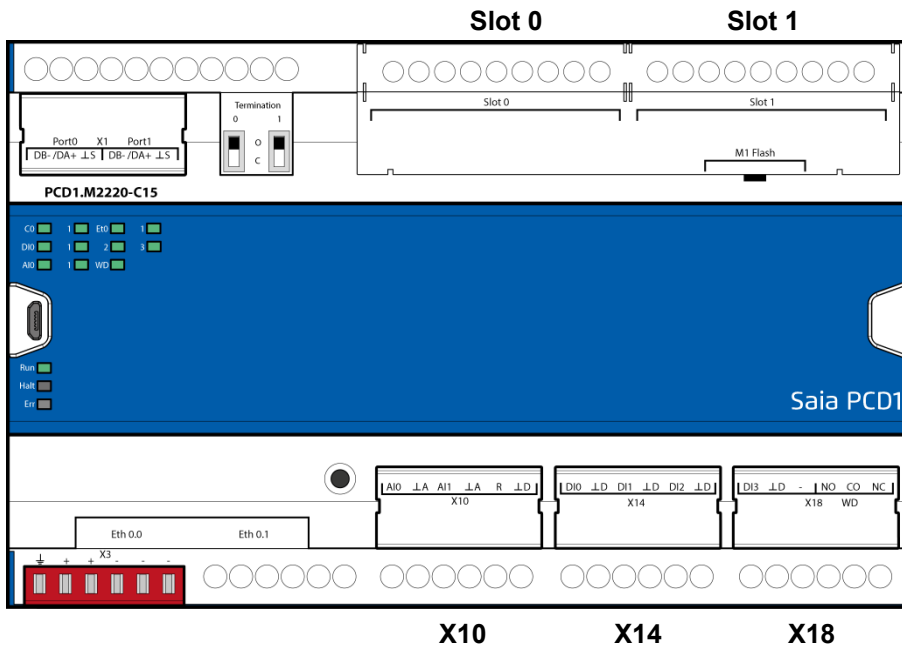

Call-up of the inputs and outputs on Slot 0 and Slot 1 for each PG5

Direct access to the IO elements from each PCD2 EA plug-in module takes place in the program using its media code and address number, separated by a space.

Example: Input 5 “I 5” or output 16 “O 16”. Where the letters “I” and “O” refer to the media code (element type) and the number is the absolute address.

Further details about programming are included in the help system of the PG5 programming tool or in the relevant manual.



All inputs and outputs on the CPU board (on-board) are assigned with the device configurator (device configurator in the PG5 tool) by the programmer to flags and registers (media mapping).

Watchdog relay address = “O 255”

The output address O 255 is reserved for the watchdog relay. The changeover contact of the relay is on connector X18.

The watchdog relay can use an alternative and the normal relay.

2

Further details are included in chapter 3.9 and 3.10 Watchdog.

Plug-in input/output modules

The IO module slots are designated with Slot 0 and Slot 1 on the device. Slot will henceforth be used as a term in this manual.

2.3 Assembly

2.3.1 Dimensions

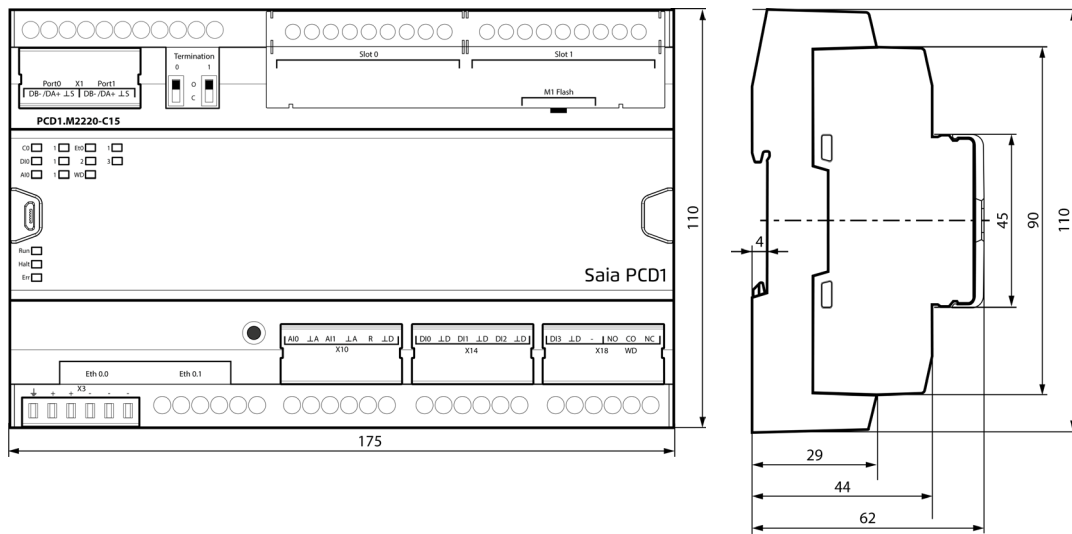

2

Dimensions in mm WxHxD = 175 x 110 x 62

2.3.2 Mounting position and ambient temperature

Normally a vertical surface is used for mounting the module carrier. An ambient temperature of between 0°C and 55°C is permitted for this mounting position.



Vertical mounting is preferable. In all other positions, the air flow is less favourable and an ambient temperature of 40°C may not be exceeded.

2.3.3 Mounting on DIN rails

The PCD1 can be locked on a horizontally mounted DIN rail (35 mm in accordance with DIN EN 60715 TH35).

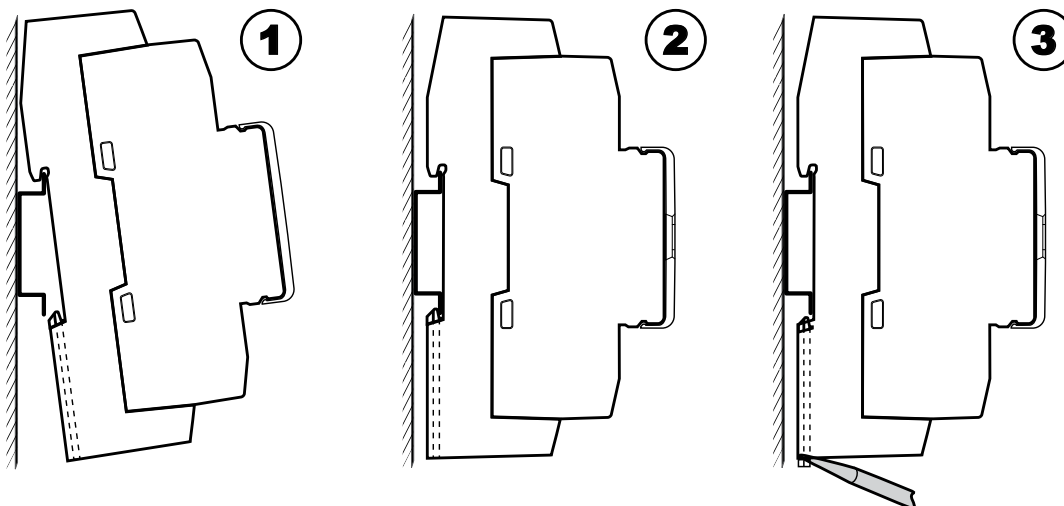

1. Hang the PCD on the upper edge of the DIN rail by both hooks.
2. Press the lower part of the PCD firmly against the lower DIN rail edge. The locking slide should lock when doing so.
3. If this is not the case because the DIN rail edges are too sharp, the locking slide can be briefly pulled back with a suitable slotted screwdriver or pushed and then released.
4. Check whether the PCD is correctly hung and locked.
5. Now equip the PCD and wire.
Remove the I/O module slot covers, see chapter 2.3.5

2.3.4 Disassembly from DIN rails

1. Identify the connection wiring and remove from the PCD.
2. Disconnect I/O plug-in modules or their terminal connections if possible.
3. Pull both locking slides back one after the other using a slotted screwdriver or push until a locking sound can be heard (see 2.2.3 > Figure 3).
4. Lift off the lower part of the PCD from the lower DIN rail edge (pull approx. 5 mm towards it) and lift up the upper edge of the DIN rail.
5. Remove the PCD
6. Press both locking slides back with your thumbs to the initial position until the locking sound can again be heard.

2.3.5 Slot cover for PCD2-I/O plug-in module Slot 0 and 1

The slot cover (marked red) at Slot 0 and 1 for PCD2 I/O module is locked in the housing of the PCD.

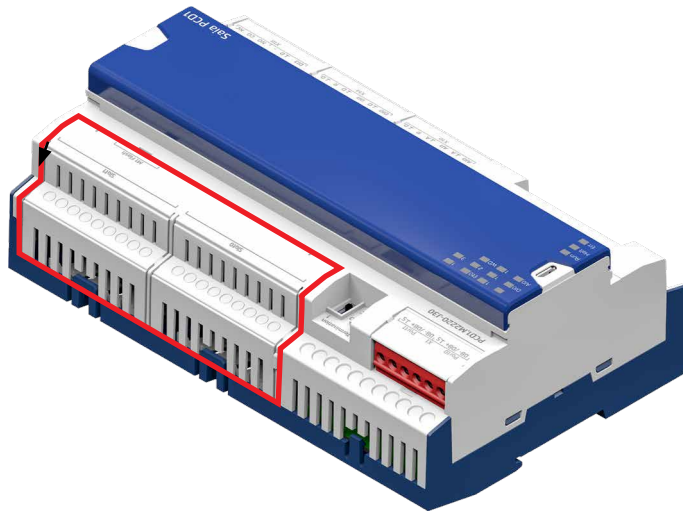

PCD1.M2220-C15 view from top

2

Examples from the large product range of PCD2 I/O plug-in modules with different connection technologies.

PCD2:E110
8 inputs 24VDC

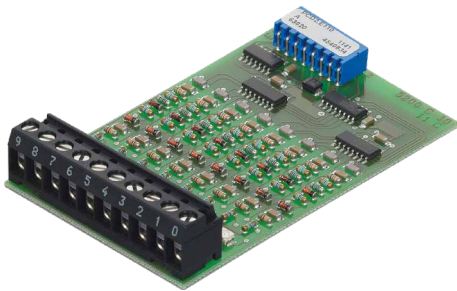

PCD2.A460
16 outputs 5 36VDC/0.5A

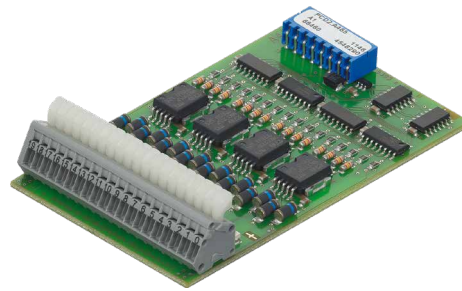

Information such as module versions, details, functional description, connection assignment, etc. can be found in the manual at www.sbc-support.com under Documents -> Manuals -> "27-600_GER_Handbuch EA-Module.pdf"

2.3.6 Process slot cover

Depending on the connection technology of the PCD2 plug-in module such as ribbon cables, etc. it is necessary to adapt the slot cover using the predefined target breaking points. For this purpose, the slot cover should be removed for processing.

If the following steps are not carried out, the side bars of the cover could bend or even break off.

Required tools:

- Side cutter
- File or knife

Removal of the slot cover

Step 1:

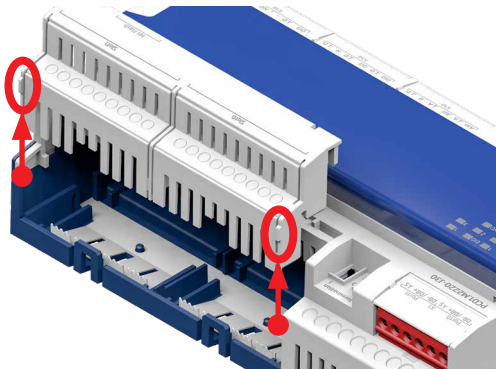

Two protruding lugs, left and right of the slot cover, facilitate gripping when pushing up.

The following work steps on the next three pages apply to both slots.

Breaking out the lower slot cover

Objective:



PCD2-IO plug modules have simpler or more complex connection technologies, depending on the function. The slot covers can therefore be adapted individually. For the PCD2.E110 module shown below, the breakout for standard connections is carried out:

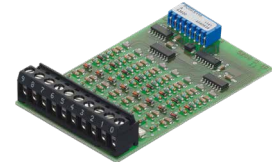

Procedure:

Step 2:

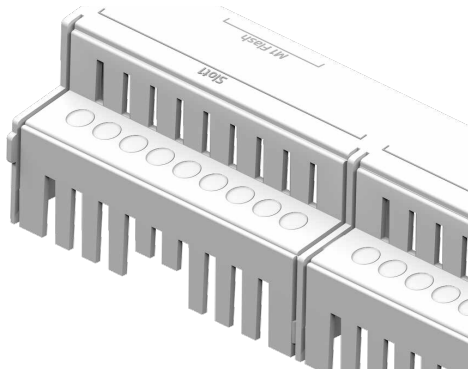

Using the side cutter, separate both the left and right slot connection bars from the main part of the slot cover.

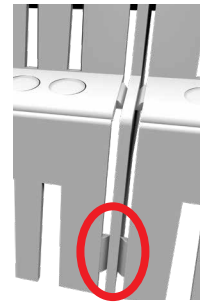

Step 3:

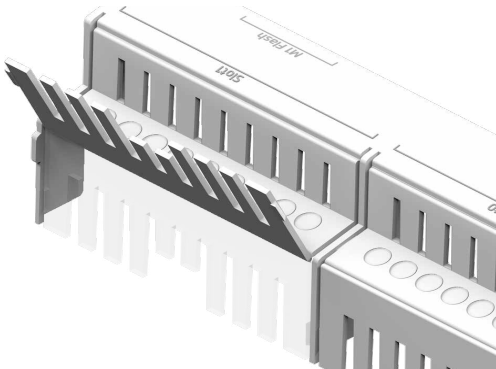

Bend the lower part of the slot on the side up and down several times until it breaks off.

Step 4:

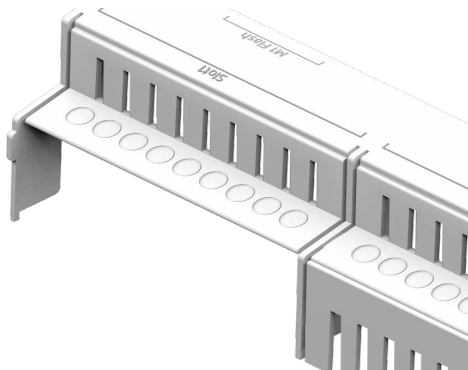

If the upper slot cover must also be removed, continue with step 5, otherwise deburr the resulting rough breaking edge with a file or knife.
Warning: risk of injury!



Breaking out the upper slot cover

Objective:

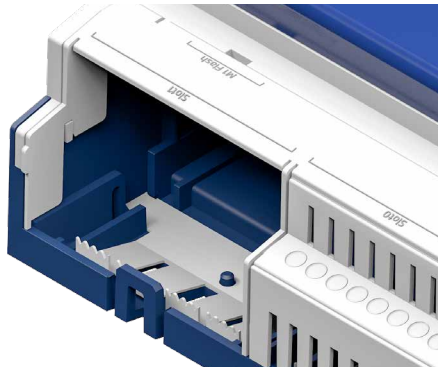

For more complex connection technologies, the upper slot cover parts can also be adapted individually. For example, here the breakout is for a PCD2.F2810 module:

2

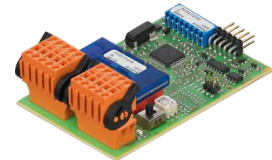

Procedure:

Step 5:

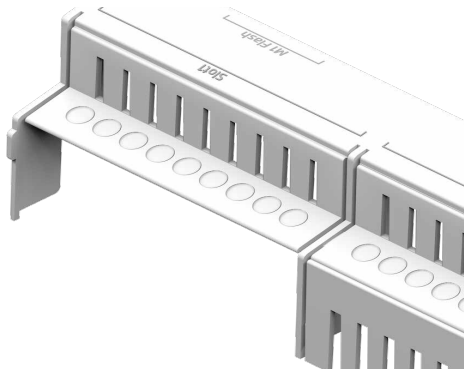

Using the side cutter, separate both the left and right slot connection bars from the main part of the slot cover.

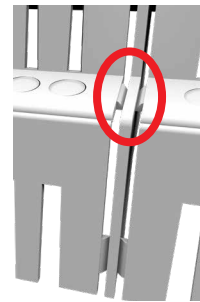

Step 6:

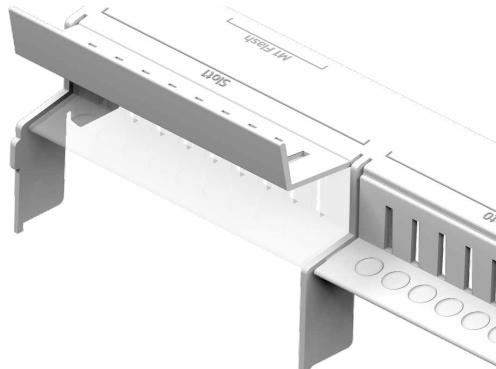

Bend the lower part of the slot on the side up and down until it breaks off.

Step 7:

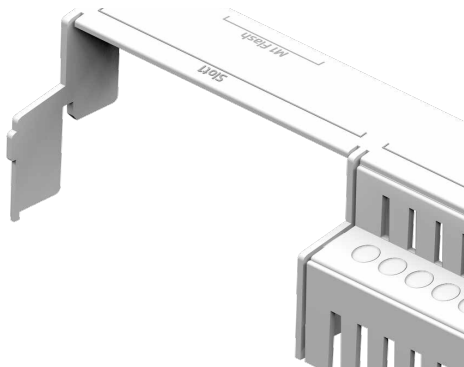

Deburr the resulting rough breaking edge with the file or knife.
Warning: risk of injury!

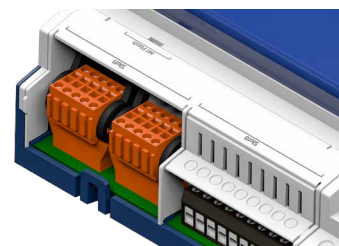

Inserting the slot cover

Step 8:

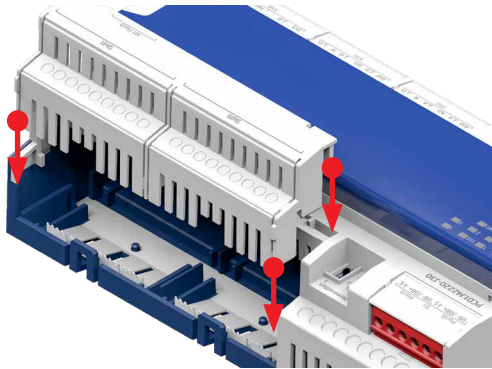

Push in the slot cover from the top until it locks.

2



It is recommended NOT to dispense with the slot cover.

Reasons for this:

- The designation Slot 0 and Slot 1 and the M1 Flash of the memory extension would be missing.
- Rough parts could fall inside the device and cause short circuits.

2.4 Handling PCD2 I/O modules



Disconnect the power supply before a module is inserted or removed on the PCD1.M2220-C15! This also applies if changes are made (e.g. insertion/removal of jumpers) to the module.

2

2.4.1 Insert module

Sheet metal parts for shielding purposes are visible on the base of the housing. These must be precisely aligned on the module slots.

Any I/O module can now be pushed in on each of these slots (Slot IO 0 + IO 1).

1. To do this, the module with the socket connector (usually with a blue colour) is first pushed in carefully and without excessive force in the direction of the system bus plug up to the stop. Guides help here.
2. When the opposite end of the module is flush with the latch of the housing base, press the module downwards in the direction of the housing base until a clicking sound is heard. This ensures that the IO plug-in module cannot fall out due to vibrations.

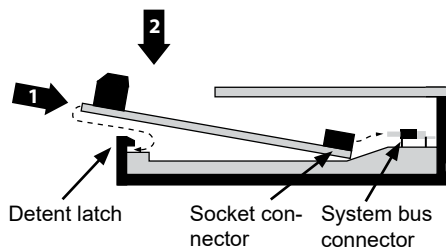

2.4.2 Remove module

Use your thumb to press the latch a max. 1 mm away from the module (i.e. from the I/O connection plug or terminal) towards the outside. Using the other hand, lift up the module at the I/O connection plug slightly above the latch and pull the module out of the slot.



Make sure that the metal claws of the shielding plate are not bent inwards with a tool (never lever out with a screwdriver). This could result in a short circuit and damage the module or controller.

2.5 Power supply and earth concept

There is a shielding plate in the upper part of the PCD1.M2220-C15 housing.

If an I/O module is inserted in a slot, the metal claws of the shielding plate in the PCD-1 housing form reliable, multiple contact points with the module.

2

The zero potential (GND) of the 24V supply is connected to the GND of supply terminal X3. This should be connected to the ground bar with the shortest possible cable (< 25 cm) with a cross section of 1.5 mm².

Any shielding of analogue signals or communication cables should also be brought to the same grounding potential, either via a negative terminal or via the ground bar. All the negative connections are linked internally. For flawless operation, these connections should be reinforced externally by short wires with a cross section of 1.5 mm².

2.5.1 Ground symbol

Symbol	Description	Function
⊥D	DGND	digital ground
⊥A	AGND	analogue ground
⊥S	SGND	signal ground
⊥		earth

2.5.2 24VDC supply

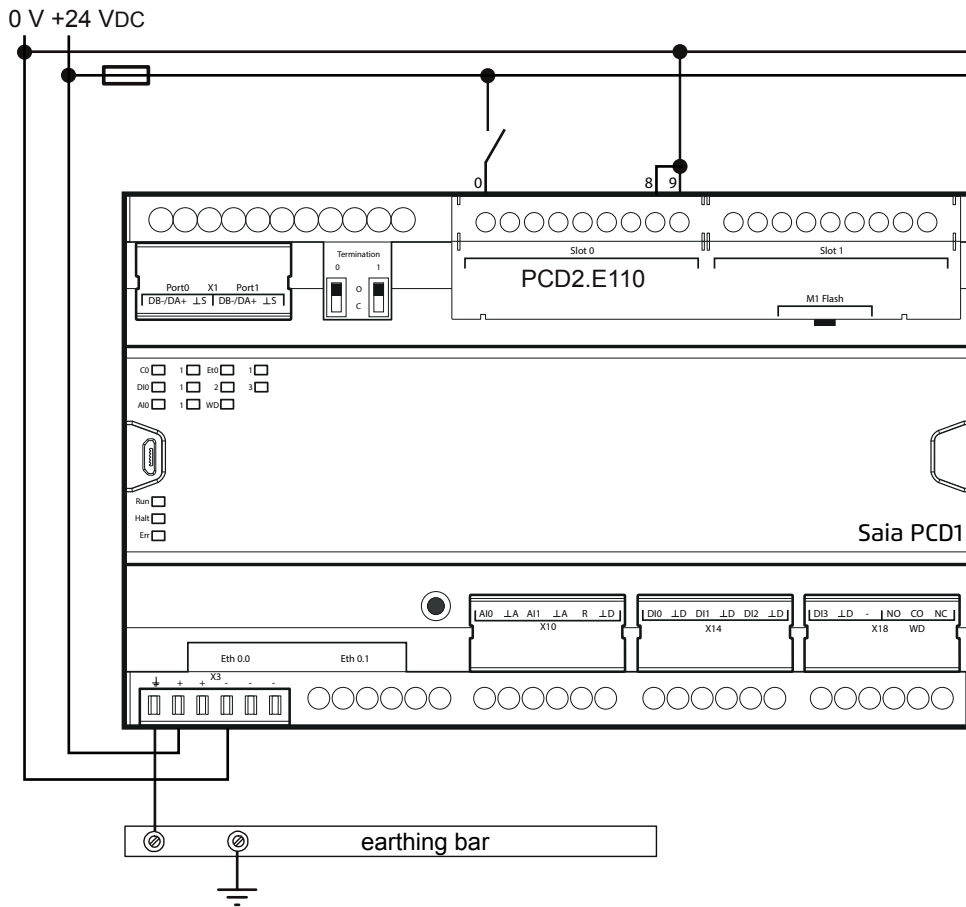

2.5.3 24VAC supply

2

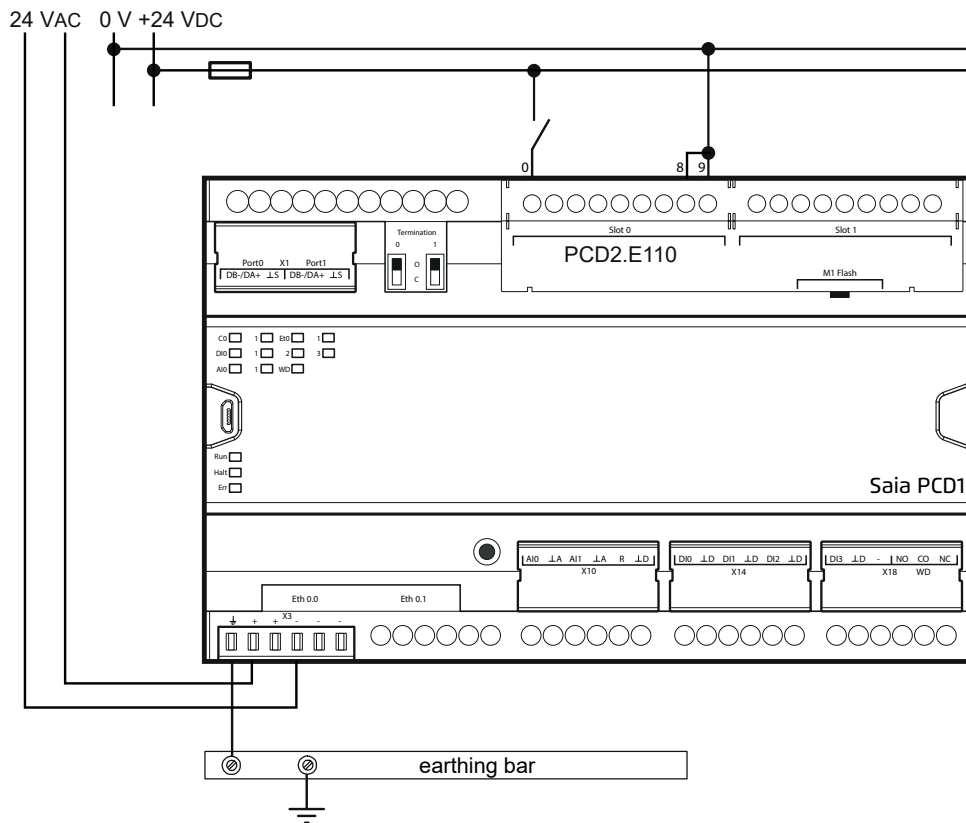

The AC and DC part is electrically isolated.

3 CPU / processor unit

3.1 Properties of the PCD1.M2220-C15 CPU

Properties	PCD1.M2220-C15
General features	
Number of PCD2 I/O plug-in module slots	2
Max. number of inputs/outputs	up to 39 ¹⁾
Processor	MCF5373L/240 MHz
Firmware, firmware update (firmware memory soldered)	Downloadable from Saia PG5 [®] environment
Programmable with Saia PG5 [®]	from V2.1.430
User program/DB/TEXT (FLASH)	512 kByte
User memory/DB/TEXT (RAM)	128 kByte
User file system (INTFLASH)	128 Mbyte
Flash memory (SRIO, configuration and backup)	128 Mbyte
Data remanence with FRAM technology (data is retained in a de-energised state)	Register, flags, data blocks and texts
Hardware clock ²⁾	✓
Hardware clock accuracy	Yes, deviation less than 1 min/month
Interfaces	
Programming interface	Micro USB type B ³⁾
Port 0 + 1	RS-485, up to 115 kBit/s
Ether S-Net interface	2 port switch
Fieldbus connections	
Serial S-Net	✓

¹⁾ With two digital I/O modules PCD2.E16x and/or PCD2.A46x each with 16 I/O

²⁾ When switched off, the power reserve of the hardware clock is retained for a minimum of 10 days (typically 20 days)

³⁾ The USB port "USB 1.1 Slave Device 12 Mbps" is used for programming.

3.2 General technical details

Power supply (external and internal)	
Power supply	24 VDC/24 VAC
Power requirement ¹⁾	Typically 120 mA
Internal bus capacity 5 V/V+	500 mA/200 mA
Environmental conditions	
Ambient temperature	For vertical mounting: 0...+55°C For remaining mounting positions, a reduced temperature range of 0...+40°C applies
Storage temperature	-25...+85°C
Relative humidity	10... 95% without condensation
Vibration resistance	
Vibrations	in accordance with EN/IEC 61131-2: - 5... 13.2 Hz constant amplitude (1.42 mm) - 13.2... 150 Hz, constant acceleration (1 g)
Electrical safety	
Protection type	IP20 in accordance with EN60529
Air/leak routes	Pursuant to EN61131-2 and EN50178: between circuits and housings and between electrically isolated circuits: overvoltage category II, pollution severity 2
Test voltage	500 VDC for rated unit voltage 24 VDC/24 VAC
Electromagnetic compatibility	
Interference immunity	in accordance with EN61000-6-2
Electrostatic discharge	pursuant to EN61000-4-2: - 4 kV contact discharge - 8 kV air discharge
High-frequency electromagnetic fields, amplitude modulated	according to EN61000-4-3: field strength - 2.0... 2.7 GHz 1 V/m - 1.4... 2.0 GHz 3 V/m - 80... 1000 MHz 10 V/m
Fast transient electrical disturbances	according to EN61000-4-4: - 2 kV or direct/alternating current supply lines - 1 kV for I/O signal lines and data communication - (2 kV for AC I/O without shielding)
High-energy surge voltages	in accordance with EN61000-4-5: - 0.5 kV CM/DM for direct current supply lines - 2 kV CM and 1 kV DM for alternating current supply lines - 1 kV CM for I/O signal lines and data communication - (2 kV CM and 1 kV DM for AC I/O without shielding)
Conducted disturbances, induced by high-frequency fields	pursuant to EN61000-4-6: 10 V 150 kHz-80 MHz
Emitted interference	in accordance with EN61000-6-4 for the industrial sector

3.3 Hardware version number

After the official version, a product is subject to improvements and modifications in subsequent years. The hardware version number identifies this type of modification. This can be used to check if a function is included with the hardware. This can be ascertained in the Saia PG5® Online Configurator under Hardware Info or on the laser inscription on the right side of the PCD1.

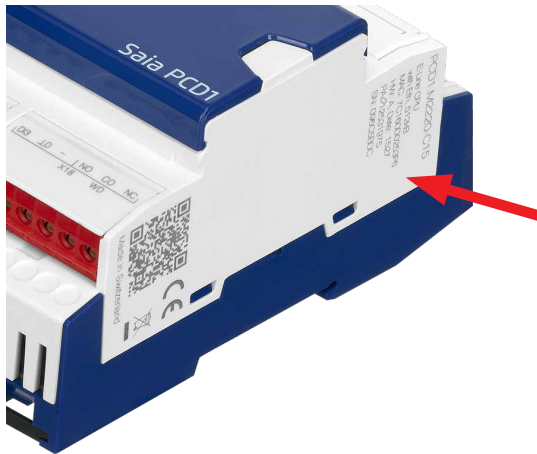

3.4 Firmware (COSinus update)



The firmware of the PCD1 is saved in a flash memory. A firmware update can be downloaded at any time to the PCD1 using the Saia PG5®.

To do this, proceed as follows:

Go to www.sbc-support.com and download the latest firmware version

3

- Establish a connection between the Saia PG5® and the CPU in the same way as downloading an application (according to the available equipment, serial with PGU cable, modem, USB, Ethernet)



A modem connection is never reliable. Modems can block a signal so that remote access is no longer possible. In these cases, a visit to the system is required. Other connection options are preferable.

- Open the “Online Configurator” and go online
- In the Tools menu, select “Update Firmware” and select the path for the file of the new firmware version with the Search function. Make sure that only one file is selected for the download
- Start the download

3.5 System memory structure

Application program code incl. ROM DB/text	512 kByte saved in the file system
User memory with FRAM technology	128 kByte FRAM for read/write access for DB and texts
PCD media with FRAM technology	Register: 16384 Flag: 16384 timer/counter: 1600
On-board user file system	128 MByte for web files, data logging, documents or backup
PLC file system	128 MByte file system partition PLC_SYS for system data and user BACKUP directory. i The user cannot access this partition (see chap. 3.8 Run/stop button)

3.5.1 Memory management of the PCDs with the COSinus OS

When the operating voltage is applied to the controller, a previously loaded program is copied from the μ SD flash memory to the CPU's own SDRAM and executed.

If there is no user program in the μ SD flash memory, the program is loaded from the M1 flash memory (if available).



When using a plug-in flash memory extension (M1 flash), the user program is not copied to the μ SD flash memory.



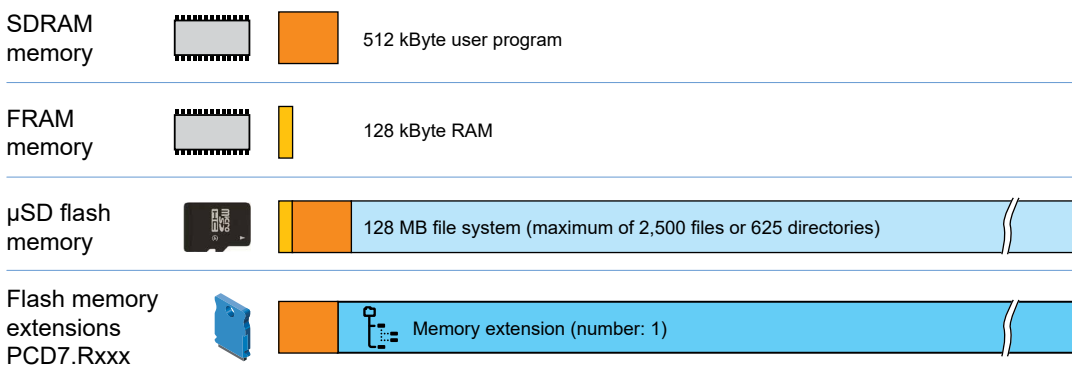

Memory expansion and resources of the Saia PCD systems

(see also Chapter 3.1 "Properties of the PCD1.M2220-C15 CPUs")



Memory structure of a PCD1.M2220-C15 with additional memory cards

3.5.2 Flash memory structure on PCD1.M2220-C15

	..	
	INTFLASH	File system for the user
	PLC	Mainly used for BACnet
	WEB	Used for linked web projects (web builder)

3

3.5.3 SD card on IO slot (PCD2.R6000)



The PCD2.R6000 memory module is not supported on the PCD1.M2220-C15 as the SD card cannot be mechanically secured.

3.5.4 Flash memory modules PCD7.Rxxx for the file system

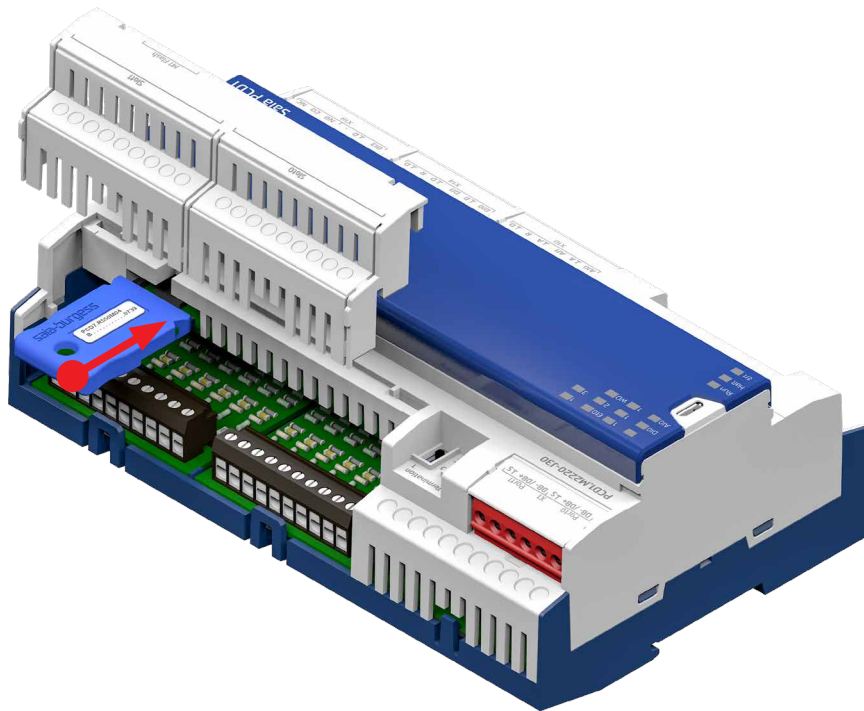



The flash card for memory expansion as a functional expansion with Lon-IP or BACnet® is inserted in the M1 flash slot provided for this.

Summary of the memory modules for PCD1 CPU

The on-board memory of the Saia PCD1.M2220-C15 can be expanded using a Saia PCD7.Rxxx module in slot M1. In addition, it can be expanded with BACnet® IP or Lon IP.

Memory expansion and communication

PCD7.R550M04	Flash memory module with a 4 MB file system (for user program backup, web pages, etc.)	M1	 PCD7.R55xM04
PCD7.R560	Flash memory module for BACnet® firmware	M1	
PCD7.R562	Flash memory module for BACnet® firmware with 128 MB file system	M1	
PCD7.R580	Flash memory module for Lon IP firmware	M1	
PCD7.R582	Flash memory module for Lon IP firmware with 128 MB file system	M1	
PCD7.R610	Base module for Micro SD flash card	M1	 PCD7.R610
PCD7.R-MSD1024	Micro SD flash cards 1024 MB, PCD formatted	PCD7.R610	

3.6 System resources

3.6.1 User program in block structure

The user program parts are saved by the programmer in blocks assigned according to their function.

Type	Number	Addresses	Comments
Cyclical organisation blocks (COB)	32	0... 31	Main program elements
Exception/system-dependent organisation blocks (XOB)	64	0... 63	accessed by the system
Program blocks (PB)	1000	0... 999	Subprograms
Function blocks (FB)	2000	0... 1999	Subprograms with parameters
Sequential blocks (SB) with total of 6,000 steps and transitions	96	0... 95	for Graftec programming of sequential processes

Block structure

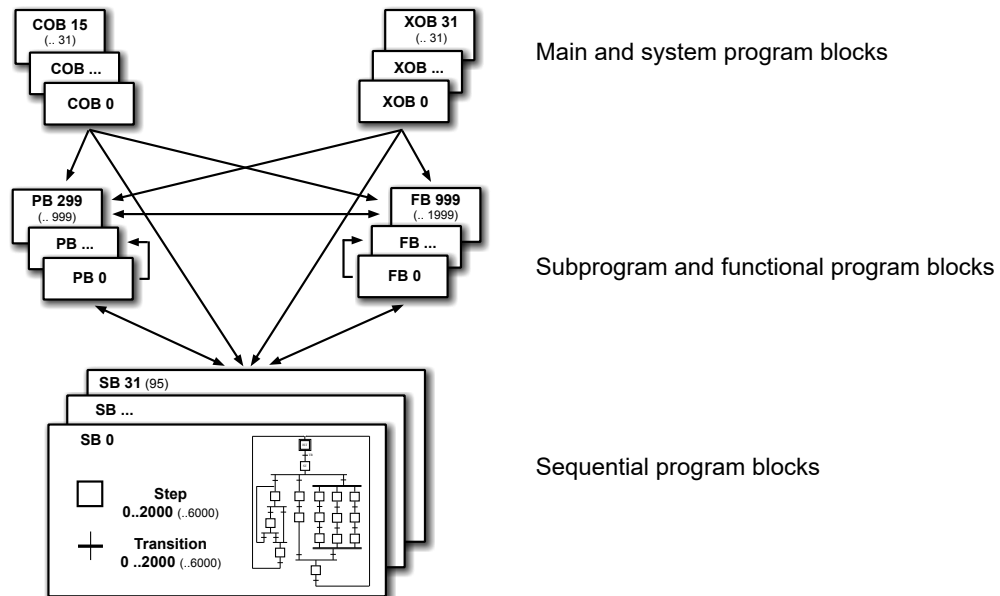

3.6.2 Data types/value ranges

Type		Comments
Integer	- 2,147,483,648 to + 2,147,483,647	Format: decimal, binary, BCD or hexadecimal
Floating point numbers	- $9,223,37 \times 10^{18}$ to - $5,421,01 \times 10^{-20}$ + $9,223,37 \times 10^{18}$ to + $5,421,01 \times 10^{-20}$	Instructions for converting values to the Saia PCD® format (Motorola Fast Floating Point, FFP) to the IEEE 754 format and vice versa provided
IEEE simple precision	$\pm 1,401 \times 10^{-45}$ to $3,403 \times 10^{38}$	double precision requires two registers (64 bit)
IEEE double precision	$\pm 4,941^{-324}$ to $1,798 \times 10^{308}$	

3.6.3 Resource elements

Type	Number	Addresses	Comments
Flags (1 bit)	16,384	F 0... 16,383	Flags are not volatile as a presetting but users can configure a volatile region originating from address 0
Register (32 bit)	16,384	R 0... 16,383	For integer and floating point values
Text/data blocks	8191	X or DB 0... 8190	For Text and DB
Timer/counter (31 bit)	1600 ¹⁾	T/C 0... 1599	The breakdown of timers and counters can be configured. Timers are counted down periodically by the operating system; the basic time unit can be set between 10 ms and 10 seconds
Constants with media code K	Any	0... 16,383	These values can be used in instructions instead of registers
Constants without media code	Any	- 2,147,483,648 to + 2,147,483,647	Can only be loaded with a LD command in a register and cannot be used in instructions instead of registers.

¹⁾ The number of configured timers should not be greater than required to prevent unnecessary CPU loads

3.6.4 Data retention

The used FRAM technology prevents data being lost if there is a power failure. A supercap is also available on this controller type just for the retention of the RTC (hardware clock). The supercap supplies the clock for at least 10 days and typically 20 days.

The following resources are saved in the FRAM:



























- Register
- Flags
- Timer
- Counter
- Strings (TEXT)
- Data blocks (DB)

3

The E-Line CPUs are maintenance-free and therefore do not require a battery.



3.7 LED operating states

Three colour LEDs in the following table display the possible operating states of the CPU.

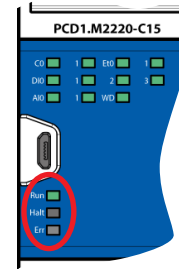
LED operating states			
Meaning	Run	Stop	Err
Form			
Colour	Green	Red	Yellow
Run			
Run conditional			
Run with error			
Run conditional with error			
Stop			
Stop with error			
Stop			
System diagnosis			



Key:

-  LED off
-  LED on
-  LED flashes

Start	Self-diagnosis for approx. 1 s after switching on or restart
Run	Normal processing of the user program after start.
Run conditional	Conditional run status. A condition was set in the debugger (Run Until...) that has not yet been fulfilled
Run with error	As "Run", but with error message
Run cond. with error	As "Run conditional", but with error message
Stop	The Stop status occurs in the following cases: <ul style="list-style-type: none"> - Program unit connected in PGU mode, while the CPU was switched on - PGU stopped by the programming unit - Condition for "Run conditional" was fulfilled
Stop with error	As "Stop", but with error message
Stop	The Stop status occurs in the following cases: <ul style="list-style-type: none"> - Stop instruction processed - Serious error in the user program - Hardware error - No program loaded - No communication mode for S-Bus PGU or Gateway Master Port
System diagnosis	
Reset	The RESET status is caused by the following: <ul style="list-style-type: none"> - Power supply too low - Firmware not started

3.8 Run/Stop button

The operating mode can be changed during operation or when switching on:

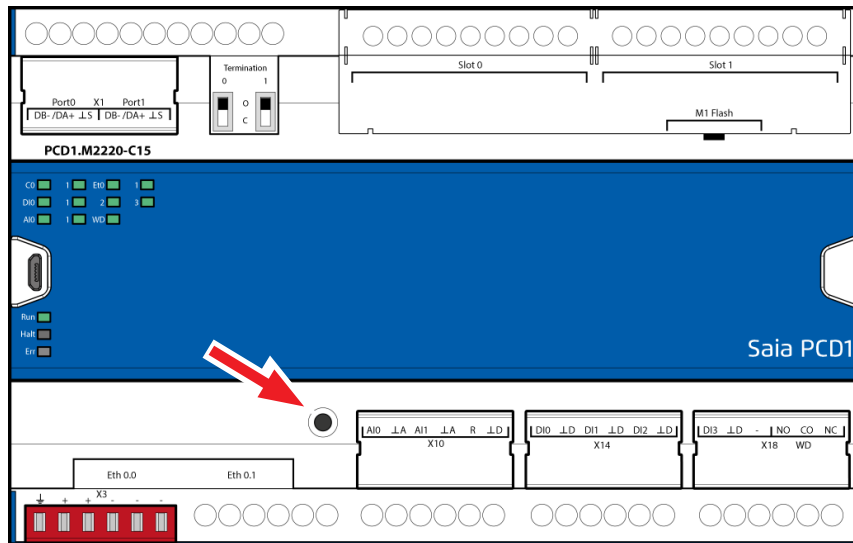

When switching on the PCD1:

if the Run/Stop button is pressed while the PCD switches on and then released during one of the subsequently described sequences, one of the following actions can be triggered:

LED sequence	Action
Green, flashing (1 Hz)	Changes to the "Boot" status and waits for FW download.
Red, with quick flashes (4 Hz)	Media/resources (flash, register, flag, etc.) is deleted. The clock is set to 00:00:00 01.01.1990. The user program is retained (content of the µSD card). CPU goes to "RUN".
Red, flashes slowly (2 Hz)	The user program does not start, CPU goes to "Stop"
Red/green, flashing (2 Hz)	Saved data is deleted: <ul style="list-style-type: none"> - User program - Hardware settings - Media/resources (flash, register, flag, etc.) - On the internal µSD card or the card in the slot "M1 flash" (selection using PG5 -> Device Configurator -> Backup location). ! When using a plug-in flash memory extension (M1 flash), the user program is not copied on the µSD card (see Chapter "3.5.4 System memory structure").

When operating the PCD1:

if the button is pressed in Run mode for longer than 0.5 seconds and less than 3 seconds, the controller changes to stop mode and vice versa.



If the button is pressed for longer than 3 seconds, the last user program saved is loaded from the plug-in flash memory extension (M1 flash).

3.9 Watchdog (relay)

3.9.1 .. as a watchdog function

With the watchdog circuit, the correct processing of the user program can be monitored with a higher level of reliability and effective safety measures can be executed in the case of error.

The PCD1.M2220-C15 CPUs are equipped as standard with this type of hardware watchdog function, or “watchdog” for short.

The active watchdog, i.e. contact in operating position (NO-CO), is displayed by the watchdog LED lit up in green.

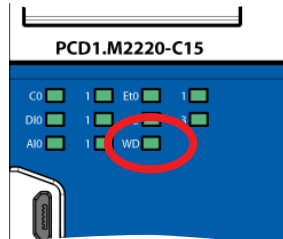

The connections of the watchdog switchover contact are on plug X18 (NO, CO and NC) and assigned to the address O 255.

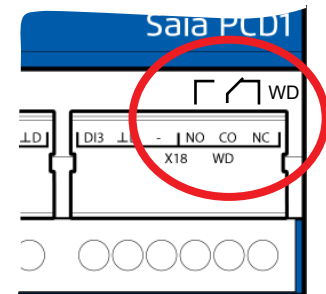

Device configuration

See “6.1.4 Digital output” > “Connection assignment for relay output”

Function description

The watchdog electronics monitor the switch-on flank at O 255. The time lapse starts for the first state change of O 255 (positive or negative flank) and the watchdog relay switches to the operating position (NO-CO).

If no other state change is executed within the set time (250 ms as standard) at O 255, the watchdog switches to the rest position (CO-NC).

If the pulse time is exceeded, this can indicate the following:

- CPU was stopped (no longer in RUN mode)
- Program execution too long (program too large or AWL program loops)

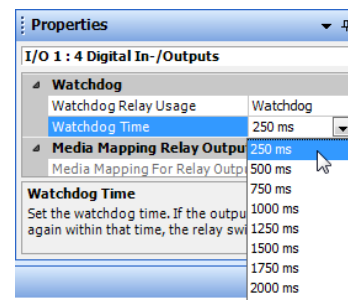

For the control of O 255 described above, FBoxes are available in the PG5 for this purpose.

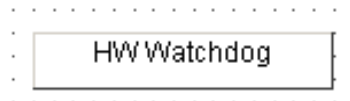
Example FUPLA FBox:

Further details regarding the FBoxes can be found in the PG5 Online Help for the FBox "HW Watchdog".

3

Example of an AWL sequence:

In the programming type instruction list (AWL), the watchdog sequence appears as follows.

Label	Command	Operand	Comment
	COB	0	; or 1 ... 31
		0	
	STL	WD_Flag	; invert help flag
	OUT	WD_Flag	
	OUT	0 255	; flash watchdog output 255
	ECOB		

With this code, the watchdog also drops out for (infinite) loops that were caused by the programmer. The following must be observed with regard to the cycle time of the user program:



For short cycle times, the code sequence must be repeated several times in the user program to prevent the watchdog dropping out during the RUN operation!

3.9.2 .. as a relay output

The watchdog relay can also be used as a normal relay output (freely switchable) as an alternative to the watchdog function.

The switched relay, i.e. contact in operating position (NO-CO), is displayed by the watchdog LED lit up in green.

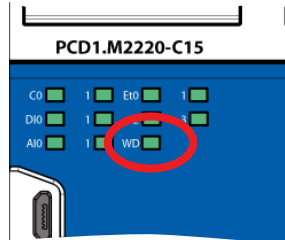

The connections of the watchdog relay switchover contact are on plug X18 (NO, CO and NC).

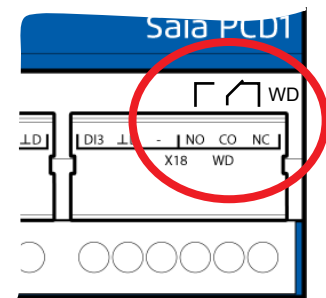

Connection assignment

See “6.1.4 Digital output” > “Connection assignment for relay output”

Device configuration

The function of the relay must be selected in the PG5 “Device Configurator”.

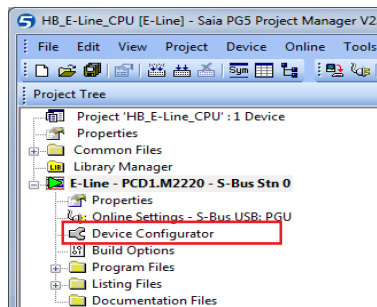

On-board inputs and outputs

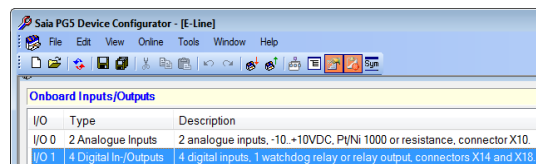

Properties overview

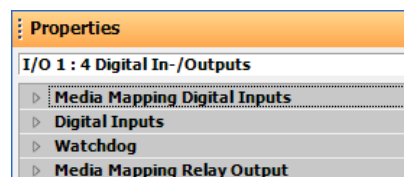

Use as watchdog relay for monitoring or by media mapping as output (“Watchdog” factory setting)

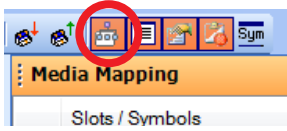
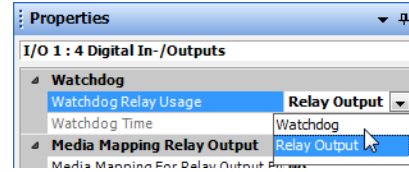

Media Mapping window call-up

Slots / Symbols	Type	Address	Comments	Scope	Tags
PCD1.M2220-C15, E-Line CPU with 512 kBytes code/text/DB flash memory and 128 kBytes extension memory (RAM for Text/...					
I/O 0, 2 Analogue Inputs, 2 analogue inputs, -10...+10VDC, Pt/Ni 1000 or resistance, connector X10.					
I/O 1, 4 Digital In-/Outputs, 4 digital inputs, 1 watchdog relay or relay output, connectors X14 and X18.					
S.IO.RelayOutput	F [1]			Public	S_IO
IO.RelayOutput	F	S.IO.RelayOutput + 0	Relais output 0	Public	S_IO

Mapping table for the status of the relay outputs

Using media mapping or direct access, the relay can be switched on or off similar to any other digital output.

Example FUPLA:

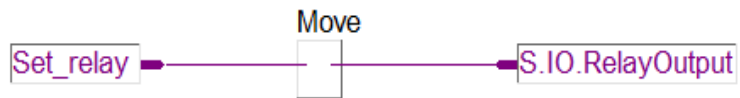

3.10 Watchdog (software)

The hardware watchdog provides maximum safety. For uncritical applications, a software watchdog may be adequate, whereby the processor monitors itself and the CPU is restarted in the event of a faulty function or a loop.

The core of the software watchdog is the AWL command SYSWR K 1000, which is also used in the FBox “Software Watchdog”.

Function

The watchdog function is activated when this is output for the first time. This instruction must then be output a minimum of every 200 ms, otherwise the watchdog will be triggered and the PCD will be restarted.

Example FUPLA FBox:

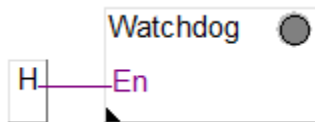

FBox Selector -> System Information -> Software Watchdog

Instruction in AWL Code:

Label	Command	Operand	Comment
	SYSWR	K 1000	; Software Watchdog instruction
		R/K x	; Parameter in accordance with the following table
			; K = constant or R = register followed by a space.
			; x = 0 The software watchdog is deactivated.
			; x = 1 The software watchdog is activated. If the instruction is not repeated within 200 ms, a cold start occurs.
			; x = 2 The software watchdog is activated. If the instruction is not repeated within 200 ms, XOB 0 is called up and then a cold start occurs.

“XOB 0” Call-ups are entered in the PCD history as follows:

- “XOB 0 WDOG START” if XOB 0 was triggered by the Software Watchdog
- “XOB 0 START EXEC” if XOB 0 was triggered by a supply error

3.11 Program download and backup



The download of the user program in the E-Line CPU with Saia PG5® and the backup and restoration of the user program is described in the PG5 Help.

4 RIO (Remote I/O)

4.1 Remote expansions

For remote expansions with inputs and outputs via Ethernet, the PCD3.RIO (Remote I/O) modules are recommended (see also manual 26-789 and 26-892).

For a detailed description of Profibus-RIOs see section 4 of the PCD3 manual 26-789.

4

E-Line CPU PCD1.M22xx-C15 decentralized RIO

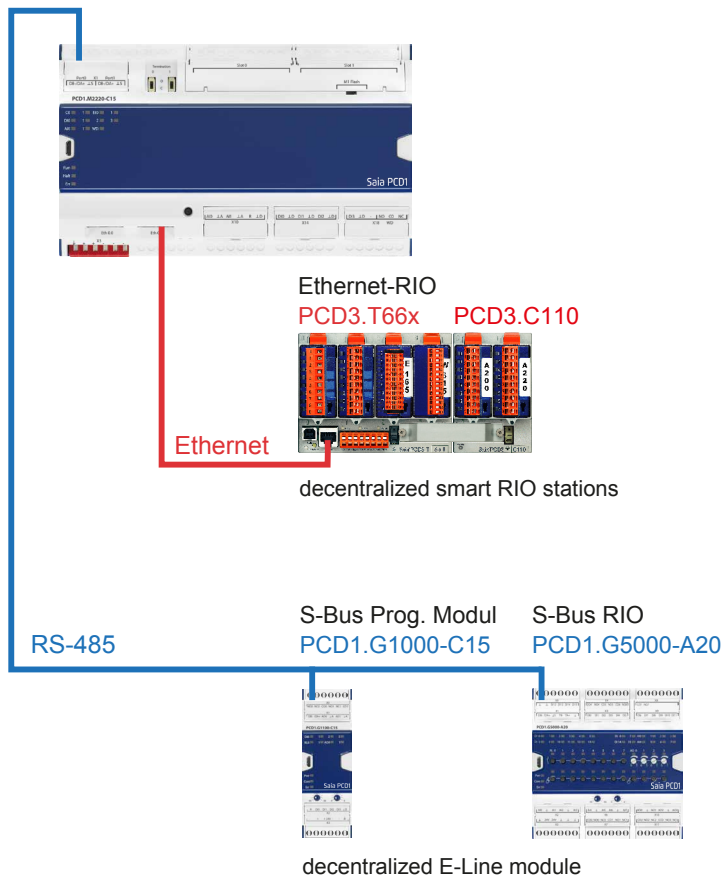

Expansion options of the PCD1.M2220-C15:

- via Ethernet with the PCD3.T66x RIOs
- via Profibus with the PCD3.T76x RIOs
- via RS-485 with the E-Line modules

5 Communication interfaces

The term “communication interface” shall be called “port” for the sake of simplicity in the rest of this manual.

5.1 Using the SBC S-Bus



The SBC S-Bus stands for the proprietary communication protocol of the Saia PCD®. Read more about this in the manual “26-739_DE_Handbuch_SBC-SBus.pdf”.

5

The SBC S-Bus is essentially designed for communication with engineering and debugging tools and to connect the management levels/process control systems. It is not suitable or approved for connecting the field devices of other manufacturers. An open, manufacturer-independent field bus is the purpose here.

5.2 On-board

In our case, the term “On-Board” denotes the CPU boards. For on-board interfaces, for example, this means that they are already supplied on the CPU board or prepared for them.

5.2.1 PGU (USB port) programming interface



Connector: USB Micro-B (device connector)
 Standard USB 1.1 device (slave),
 full speed 12 Mbps,
 with Softconnect

The USB port is only used as a PGU interface. To use the USB interface, the program packet PG5 version 2.1 or later must be installed on the PC.

If the PCD is connected via the USB port with a PC for the first time, the PC operating system (Windows) automatically installs the appropriate PCD USB driver. The PCD is connected via USB using the following setting in the PG5 project folder for the respective device under “Online Settings”:

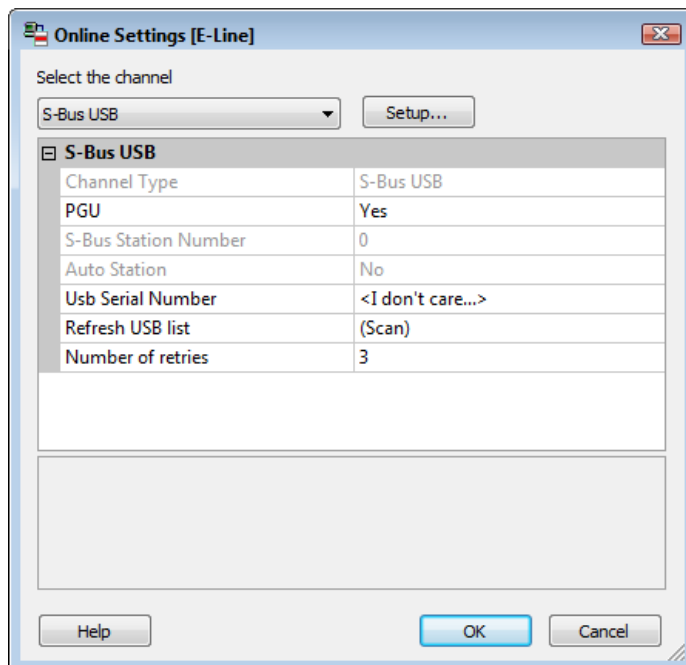

The activation of the “PGU Option” ensures that the PC can be directly connected to the PCD independent of the configured S-Bus address.

5.2.2 Ethernet (Eth0.0/Eth0.1) port #9

For the Ethernet connection, a 10/100 Mbits switch is used that automatically adapts both speeds. Both sockets with the same Ethernet address can be used independently of each other with respect to the speed.

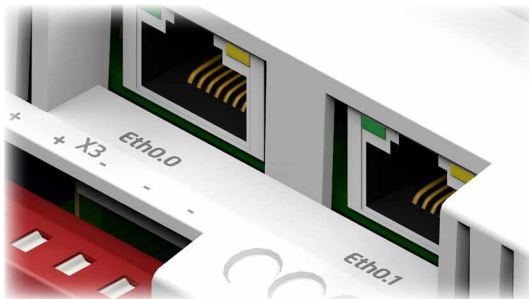

Eth0.0

Eth0.1

Function	2 port switch	
Socket type	RJ45, metal housing, 2 LEDs each	
LED Et0 and Et1 	LED orange	Link (connection) and activity
	LED green	Speed off = 10 Mbits / On = 100 Mbits
Port	9	
Cabling	Standard Ethernet cable (e.g. Cat 5e) uncrossed and crossed are supported.	

5.2.3 RS-485 (port#0+1) electrically isolated (terminal block X1)

Up to two RS-485 connections can be used without additional hardware.

Communication mode S-Bus and Modbus can be realised via Port0 and/or Port1 on terminal block X1.

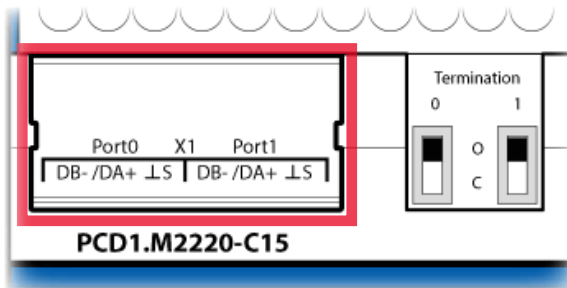

Terminal block X1

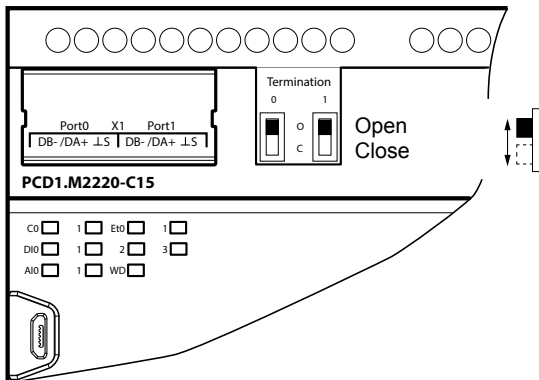
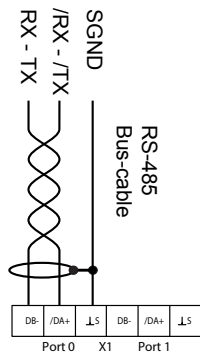

RS-485 connections and terminating resistor switches (termination) for Port0 and Port1

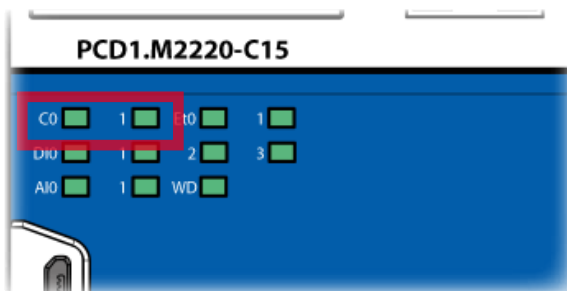

LEDs Port0 and Port1

**“Termination 0” and “Termination 1” switch
(switching the RS-485 terminating resistor on or off)**

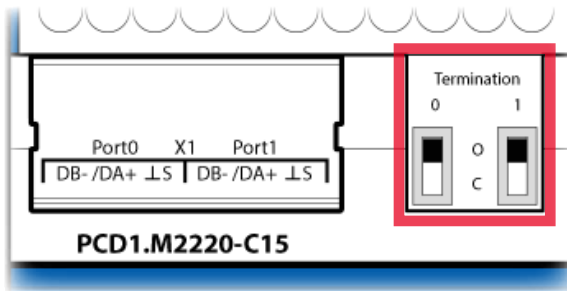

RS-485 terminating resistor switch for Port0 and Port1



With both of the switches mentioned above to the right of terminal block X1, the terminating resistors at both external stations of both S-Bus wires that are isolated from each other are switched on and off.

- The switch must be set to “C” (closed) at both external stations of the RS-485 line.
- The switch must be in position “O” (open) for all other stations.

Schematic diagram of a RS-485 bus with terminating resistances.

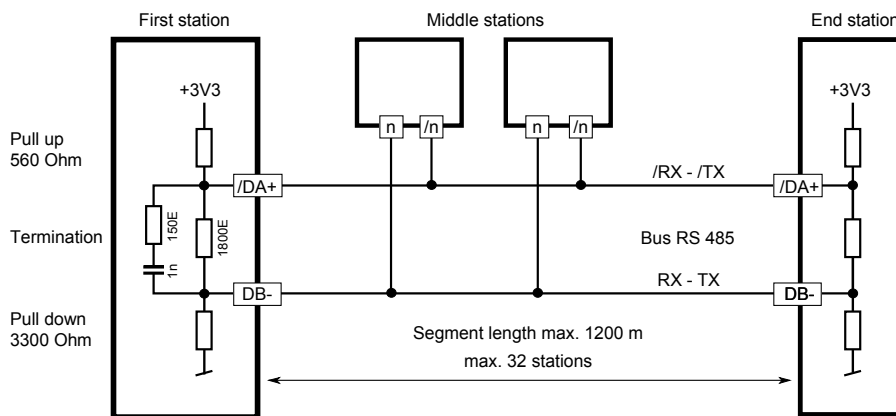

More details can be found in “26-740_DE_Handbuch_RS485-Komponenten Netzwerke”.

5.3 Interfaces using PCD2 plug-in modules PCD2.F2xx



Please note:

The E-Line CPU has no “Slot A” slot for a PCD7.F1xxS interface module!

The PCD1.M2220-C15 can be expanded with a maximum of two PCD2.F2xxx module cards with two fixed interfaces each (carrier card with fixed interface of choice and a socket for PCD7.F1xxS interface modules) on the two free PCD2 module slots (Slot 0 and Slot 1) that can be equipped.

Maximum 6 serial interfaces

(2x on-board and 2x PCD2.F2xxx (each with 2 interfaces))

5

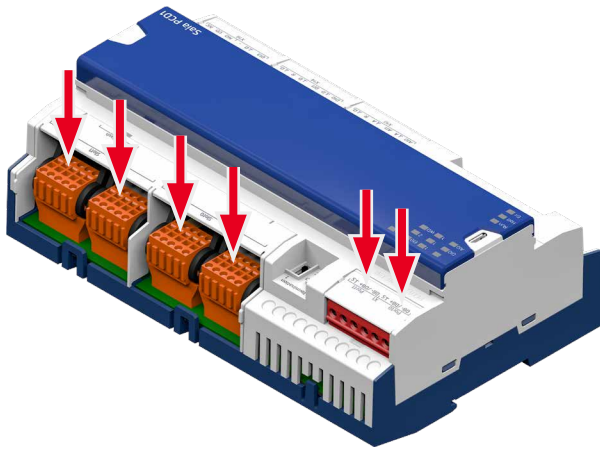

PCD1.M2220-C15 with 2 PCD2.F2xx and possibly a PCD7.F1xxxS

5.3.1 General notes for the plug-in module PCD2.F2xxx

System properties of PCD2.F2xxx modules:

The following points must be noted when using the PCD2.F2xxx interface modules:

- A PCD2.F2xxx module (for 2 interfaces) can be used for each PCD1 system per I/O slot. This means a total of 4 additional interfaces.
- The PCD1.M2220-C15 system has a powerful processor that handles both the application and the serial interfaces. Processing of the interface modules requires the appropriate CPU capacity. To determine the maximum communication capacity for each PCD1.M2220-C15, note the following:

The communication volume is determined by the connected peripheral devices. For example, this applies if a PCD1.M2220-C15 is used as the S-Bus slave station. If the PCD1.M2220-C15 is bombarded with heavy telegram traffic at high baud rates, there is less CPU capacity to handle the actual application. The following rules apply here:

- The use of 6 interfaces with 9.6 kbps requires approx. 50% of the CPU capacity.
- 2 interfaces with 57.6 kbps require approx. 50% of the CPU capacity.
- 2 interfaces with 115 kbps require approx. 60% of the CPU capacity.
- If the PCD1.M2220-C15 is used as a master station, the communication volume and therefore the communication capacity is dependent on the user program in the PCD1.M2220-C15. Theoretically all interfaces with a maximum baud rate of 115 kbps can be operated. The effective data throughput is reduced by the size of the user program and the number of active interfaces. The essential factor is that the connected peripheral devices can work with the selected configuration and communication capacity.

5.3.2 Port addresses for PCD2.F2xx on Slot 0 and/or Slot 1

The slots can be accessed with the following port addresses using communication FBoxes:

Slot 0 with PCD2.F2xxx module

- Port 100 for the 0.0 port
- Port 101 for the 0.1 port
(with PCD7.F1xxx)

Slot 1 with PCD2.F2xxx module

- Port 110 for the 1.0 port
- Port 111 for the 1.1 port
(with PCD7.F1xxx)

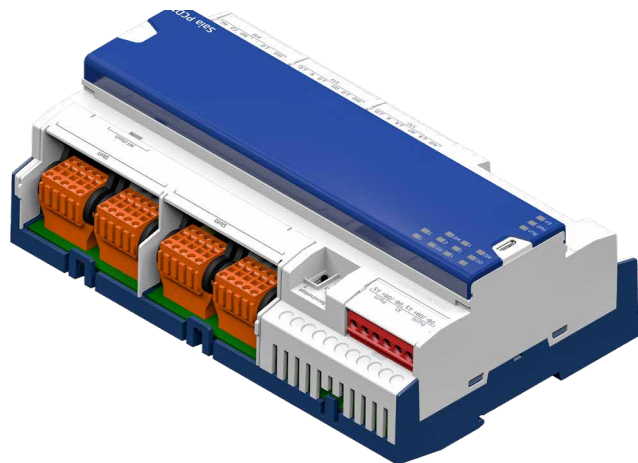

See manual 27-649_GER_Handbuch_PCD2F2xxx.

5.4 Modem communication

Modem PCD2.T8xx

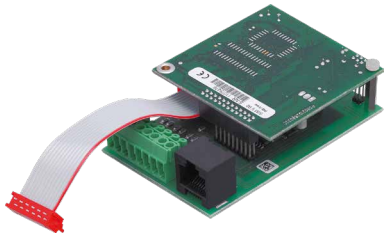

PCD2.T814:
Analogue modem 33.6 kbit/s
(RS-232 and TTL interface)

PCD2.T851:
Digital modem ISDN TA
(RS-232 and TTL interface)



The IO module modem PCD2.T8xx is not supported on the PCD1.M2220-C15.
Please use external modems.

5

6 Inputs and outputs

This chapter describes the function and connection assignment of the inputs and outputs of the PCD1.M2220-C15.

Three options are described where the inputs and outputs can be located. These are:

- On-Board
- as plug-in modules
- on RIOs

6.1 On-board

On-board denotes “mounted on the CPU motherboard”.

For an overview, see the next subchapter 6.1.1

6.1.1 Connection overview

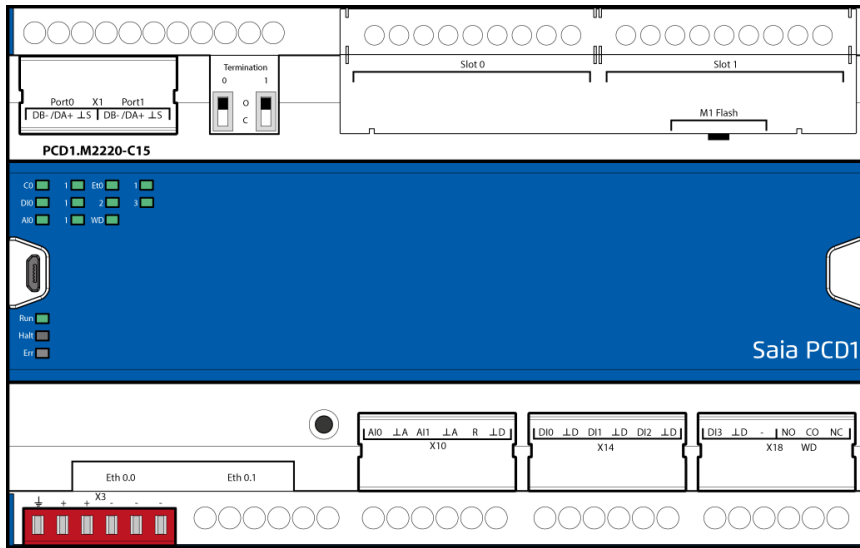

X1	
DB- /DA+	RS-485 Port 0
LS	Signal ground
DB- /DA+	RS-485 Port 1
LS	Signal ground

Slot 0	Slot 1
...	...
Can be equipped with plug-in modules from the PCD2 family.	

X3	
⊥	Earth
+	+24V AC/DC
+	
-	0V AC/DC
-	

X10	
AI0	Analogue input 0
LA	Analogue ground
AI1	Analogue input 1
LA	Analogue ground
R	Source and sink operation (active level resistor)
LD	Digital ground

X14	
DI0	Digital input 0: 24V AC/DC
LD	Digital ground
DI1	Digital input 1: 24V AC/DC
LD	Digital ground
DI2	Digital input 2: 24V AC/DC
LD	Digital ground

X18		
DI3	Digital input 3: 24V AC/DC	
LD	Digital ground	
-	Not assigned	
NO	Watchdog or relay output	Normally open
CO		Centre contact
NC		Normally closed

6.1.2 Digital inputs (terminal block X10, X14, X18)

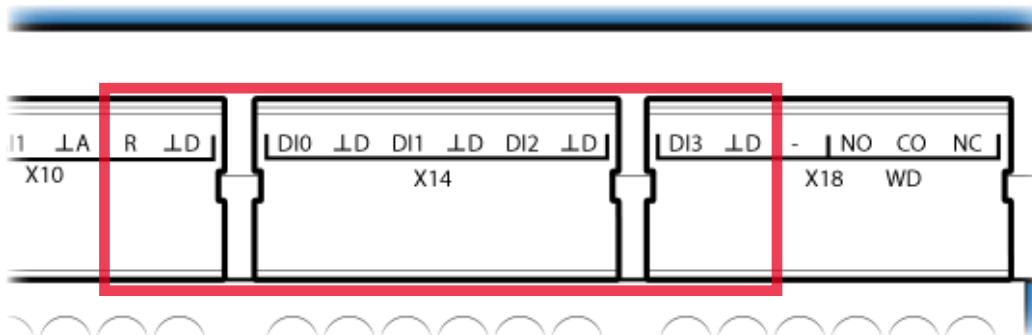

Connections for digital inputs DI0 to DI3. Terminal block X10, X14 and X18

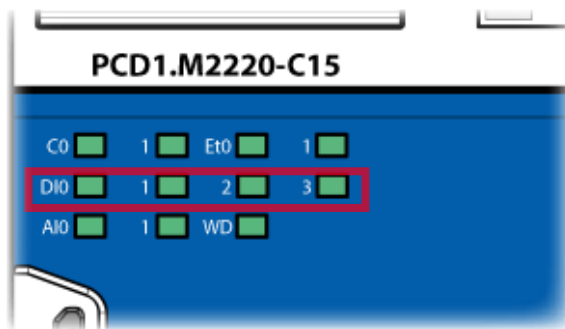

LEDs for the digital inputs DI0 to DI3

Technical data

Number of inputs	4, source/sink operation, electrically connected
Electrically isolated	From supply and other I/O
Input voltage	Typically 24 VAC/VDC (15...30 VDC, 15... 28 VAC)
Input current	Typically 4 mA at 24 VAC/VDC
Input delay	0 ms (AC), 8 ms (DC) (selectable in the Device Configurator)
Switching level	Low: 0... 5 V, High: 15... 30 VDC Low: 0... 5 V, High: 15... 28 VAC
Overvoltage output protection	No
LED	DI0... 3
Terminal technology	Plug-inspring terminals up to 1.5 mm ²

Definition of input signals

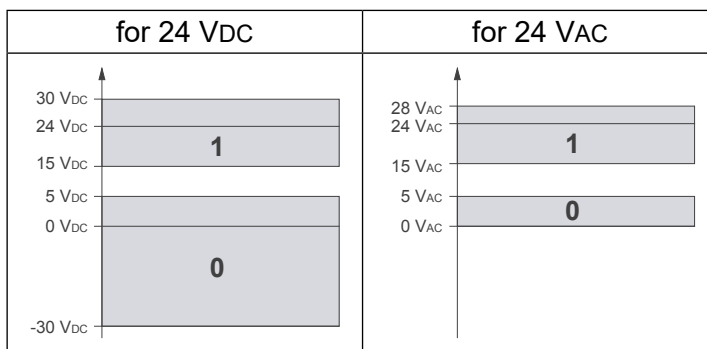

Input switching and terminal designation

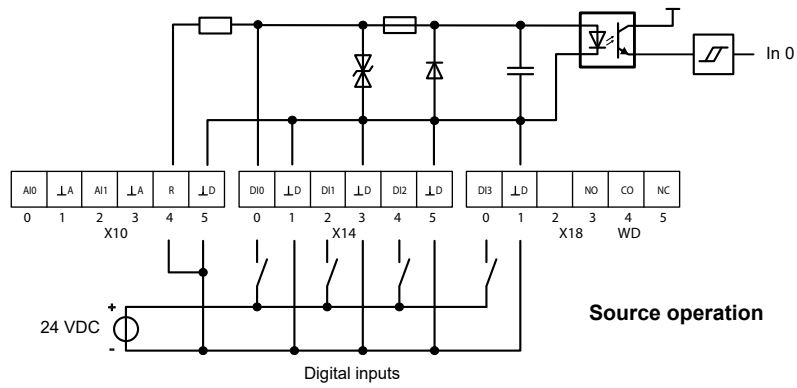

Source operation

DC wiring "source operation" (plus switching)

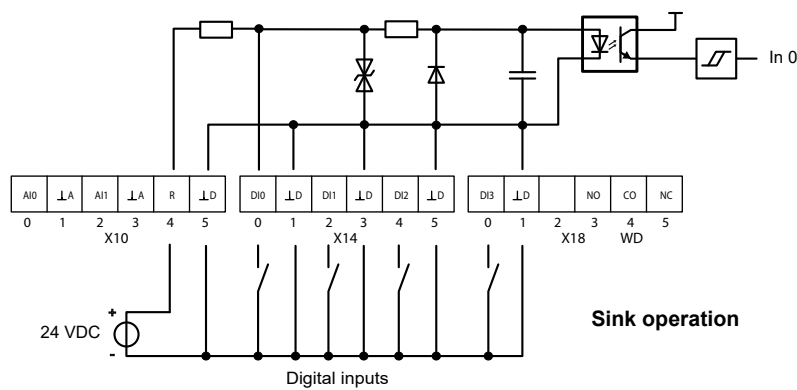

Sink operation

DC wiring "sink operation" (ground switching)

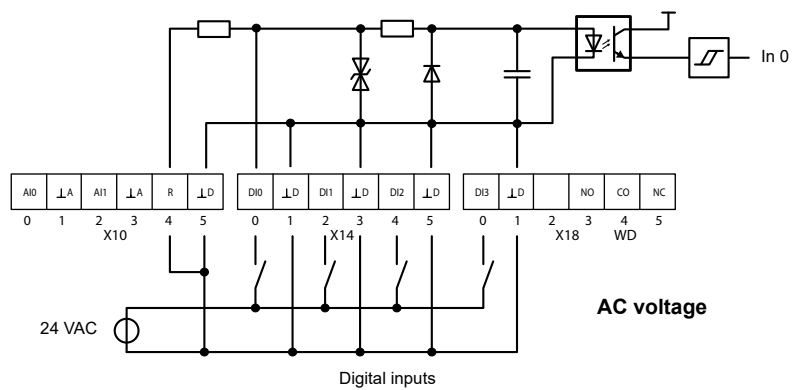

AC voltage

AC voltage wiring

6



To constantly detect a '1', the frequency must be at least 48 Hz for AC voltage!

6.1.3 Analogue inputs (terminal block X10)

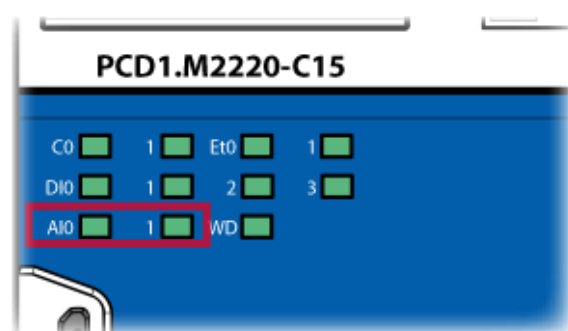
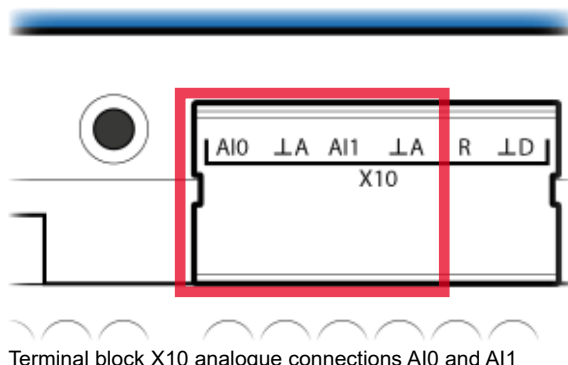

6

Technical data

Number	2 (AI0, AI1)	
Electrically isolated	No	
Connection technology for sensors	2-wire (passive input)	
Measuring principle	One-sided	
LED	AI0, AI1 active for >5% of minimum value	
Terminal technology	Plug-in spring terminals up to 1.5 mm ²	
Signal range and measured values (can be set via the Saia PG5 Device Configurator)	Voltage measurement ... -10V ... +10V Resistance 0 Ω ... 2500 Ω 0 Ω ... 7500 Ω 0 Ω ... 300 kΩ NTC10k 0 Ω ... 300 kΩ NTC20k 0 Ω ... 300 kΩ Pt1000 -50°C ... +400°C Ni1000 -50°C ... +210°C Ni1000 L&S -30°C ... +140°C	
Maximum input voltage	+/- 20V (independent of input configuration) voltages > 15V / < -15V can result in incorrect values at other inputs	
Input delay	Channel update	10 ms (all channels are updated during this time)
	Hardware input filter time constant	Voltage measurement τ = 5 ms resistance τ ≈ 2.2 ms
	Software input filter	Connectible using Saia PG5 Device Configurator (forms the average value of the last 16 values)

Configuration of the analogue input channels:

The selection of the analogue input range is made via the “Device Configurator”.

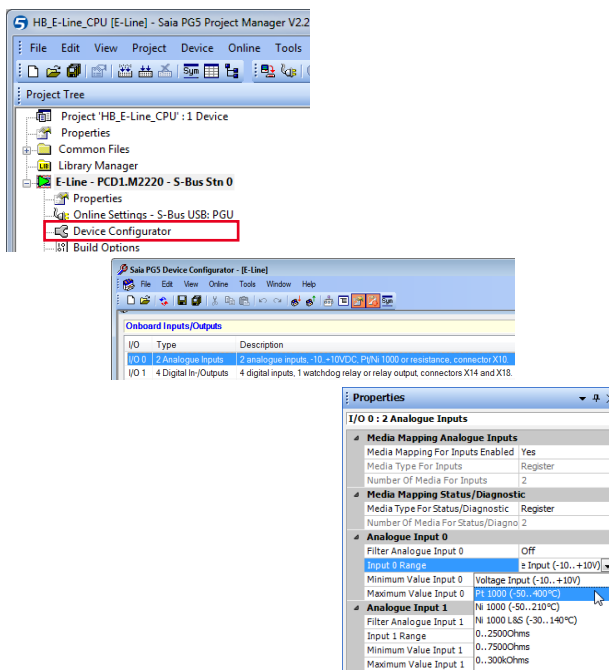

Mode	Resolution [bit]	Resolution [measured value]	Accuracy (at T _{Ambient} = 25°C)	Display
Voltage -10V ...+10V	12 + sign	2.44 mV (linear) $R_{IN} = 220\text{ k}\Omega$	0.3% of the measured value +/- 10mV	-10000... 10000 (standard) or user scaling
Resistance 0... 2500 Ω	12	0.50 ... 0.80 Ω <i>Measured current: 1.0 ... 1.3 mA</i>	0.3% of the measured value +/- 3 Ω	0... 25000
0... 7500 Ω	12	0 ... 3000 Ω : 1 ... 2 Ω 3000 .. 7500 Ω : 2 ... 4 Ω <i>Measured current: 0.6 ... 1.3 mA</i>	0.3% of the measured value +/- 8 Ω 0.3% of the measured value +/- 15 Ω	0... 7500
0... 300 k Ω	12	0 ... 15 k Ω : 1 ... 10 Ω 15 ... 40 k Ω : 10 ... 40 Ω 40 ... 70 k Ω : 80 ... 200 Ω 70 ... 100 k Ω : 200 ... 400 Ω 100 ... 300 k Ω : 0.4 ... 3.5 k Ω <i>Measured current: 30 μA ... 1.3 mA</i>	1.0% of the measured value +/- 80 Ω 2.0% of the measured value +/- 320 Ω 5.0% of the measured value +/- 400 Ω 8.5% of the measured value +/- 1600 Ω >8.5%	0... 30000
NTC10k ^[1]	12	-40 .. +120°C: 0.25 .. 0.15°C -10 ... +80°C: 0.05 .. 0.06°C +5 ... +60°C: < 0.04°C	< -20°C: > +/- 2.0°C -20... +120°C: +/- 2.0°C -10... +80°C: +/- 1.0°C +5... +60°C: +/- 0.5°C	-400... 1200 ^[1]
NTC20k ^[1]	12	-20 .. +150°C: 0.15 .. 0.30°C -5 ... +120°C: 0.07 .. 0.13°C +5 ... +95°C: 0.05 .. 0.06°C +14 ... +75°C: < 0.04°C	< -10°C: > +/- 4.0°C -10... +150°C: +/- 4.0°C -5... +120°C: +/- 2.0°C +5... +95°C: +/- 1.0°C +15... +75°C: +/- 0.5°C	-200... 1500 ^[1]
Pt 1000	12	-50 .. +400°C: 0.15 .. 0.25°C <i>Measured current: 1.0 ... 1.3 mA</i>	0.3% of the measured value +/- 0.5°C	-500... 4000
Ni 1000	12	-50 .. +210°C: 0.09 .. 0.11°C <i>Measured current: 1.0 ... 1.3 mA</i>	0.3% of the measured value +/- 0.5°C	-500... 2100
Ni 1000 L&S	12	-30 .. +140°C: 0.12 .. 0.15°C <i>Measured current: 1.0 ... 1.3 mA</i>	0.3% of the measured value +/- 0.5°C	-300... 1400

[1] These temperature curves are not standardised. They differ depending on the manufacturer of the NTC. The temperatures can be represented with a characteristic curve file (saidbde, available from Saia-PCD Support) and the FBox “Conversion DB n Points”.



Prefigured in the delivery state to -10... +10V (12 bit + sign).

Programming

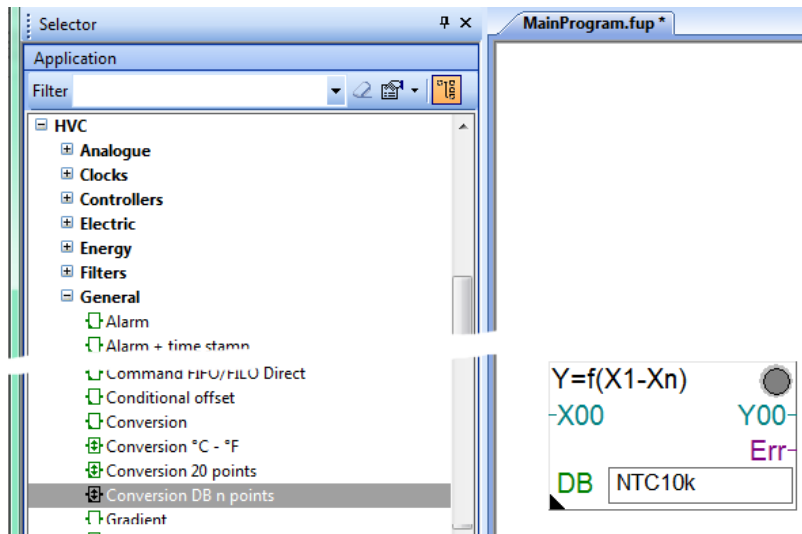

6

Definition for range, over range, under range and status flag:

Temperature inputs:

Type	min./max. Status flag	Range values
Pt 1000 (-50... 400°C)	-500 / 4000	Limits -500... 4000
Ni 1000 (-50... 210°C)	-500 / 2100	Limits -500... 2100
Ni 1000 L&S (-30... 140°C)	-300 / 1400	Limits -300... 1400
-10 ... + 10V	-12 / + 12	Limits -10100... 10100
0 ... 2500 Ω	0 / 25500	Limits 0... 25500
0 ... 7500 Ω	0 / 7650	Limits 0... 7650
0 ... 300 kΩ	0 / 30600	Limits 0... 30600

Each time the min./max. values are reached, the min./max. status flag is set.

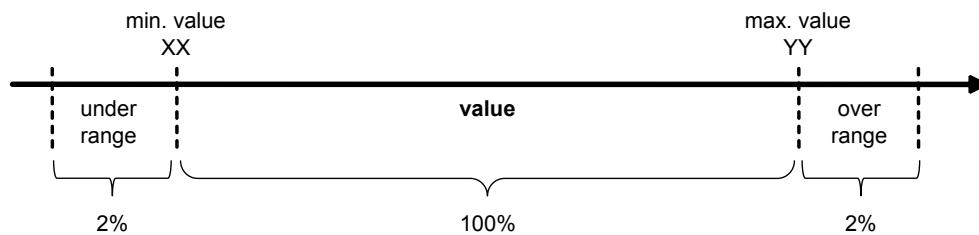

The status flag remains set until the status has been read.

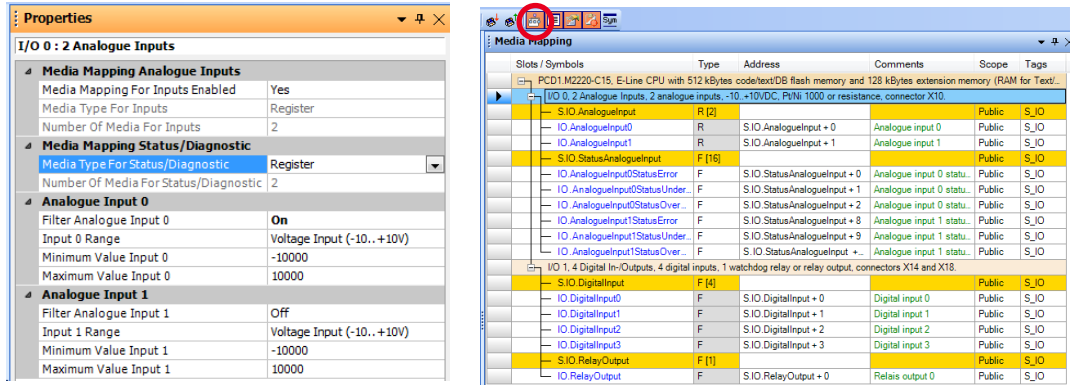

PG5 Device Configurator for PCD1.M2220-C15 > Properties > Media Mapping

6

With media mapping, the status flag at the end of each COB is read. This means that the status flag at the end of each COB is reset.

For direct access, the status flag is reset as soon as the user program reads the status flag.

Connection diagram:

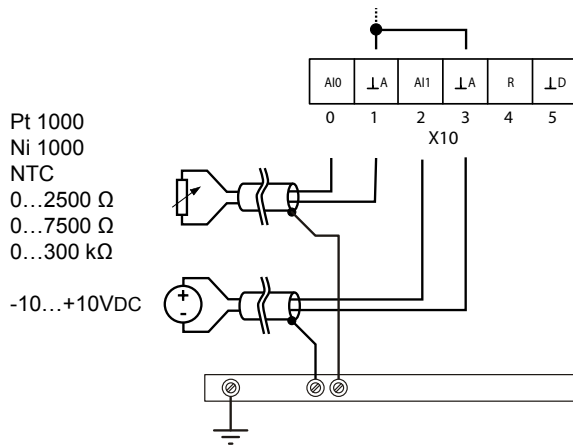

6.1.4 Digital output

The watchdog relay is available as a digital user output if it is not used for monitoring.

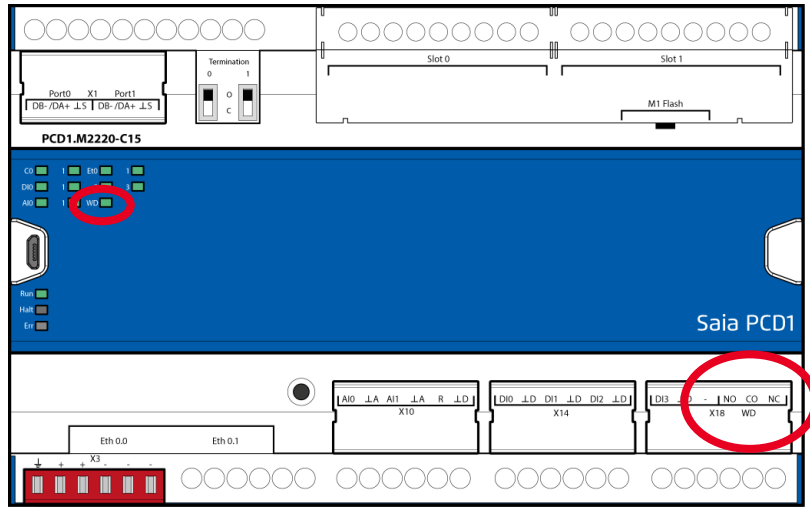

6

Technical data

Number of outputs	1 × relay switching contact
Function	Watchdog function or user output (selectable)
Max. voltage	48VAC or VDC
Switching capacity	1A (with DC switch-on voltage, a freewheeling diode should be connected in parallel to the load)

Connection assignment for watchdog function

Watchdog-Relais
Power "dangerous" outputs

PCD1.M2220-C15

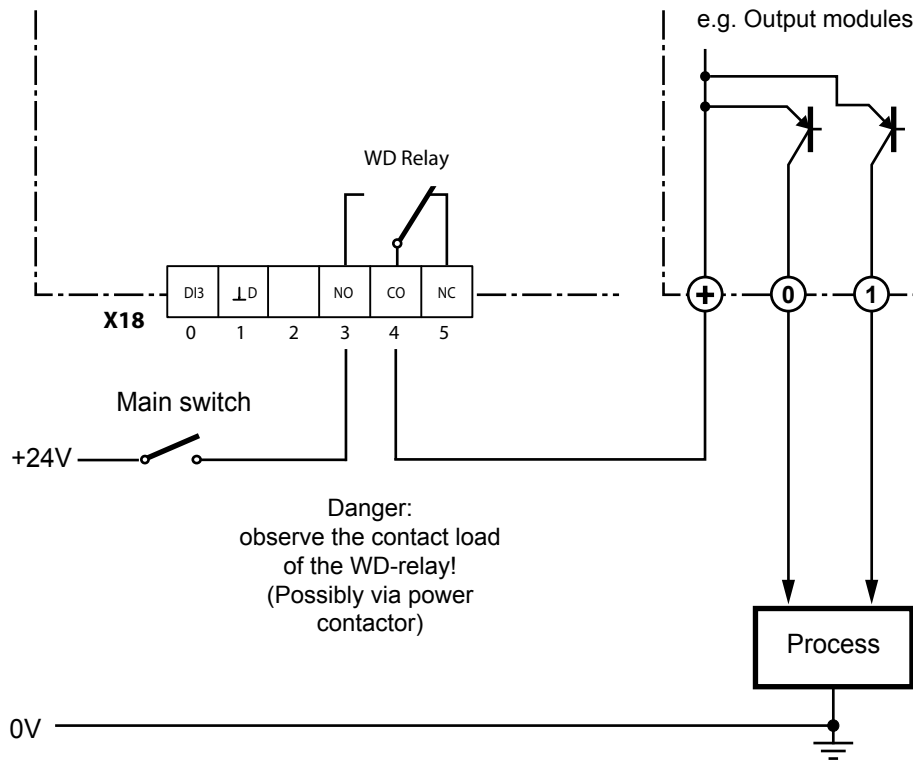

6



Configuration and description, see "3.9.1 ... as a watchdog function"

Connection assignment for relay output

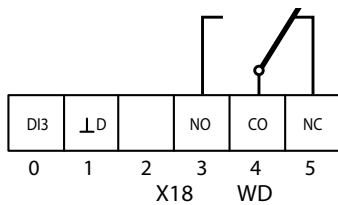

Configuration and description, see "3.9.2 ... as a relay output"

6.2 I/O plug-in modules for Slot 0 and Slot 1

I/O modules from the PCD2 family are used as I/O modules.

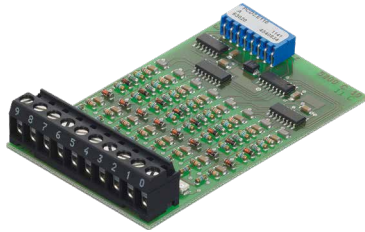

PCD2.E110

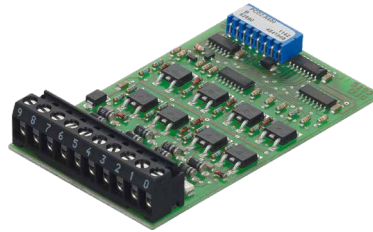

PCD2.A400

etc.

The descriptions of the IO modules are included in the document
“27-600 GERxx Manual IO Modules”

6



I/O modules and I/O terminal blocks may only be removed or inserted when the Saia PCD® is in a de-energised state.
The external voltage supply of the modules +24V must also be switched off.

7 System cables and adapters

7.1 System cables with I/O module connections for PCD

A range of preconfigured cables is available to prevent potential errors and save time. The module plug is already mounted at one end of the cable, so only this side has to be plugged in. Depending on the design, the other end of the cable has ribbon connectors for the terminal adapters or the relay interface, or individual 0.5 mm² or 0.25 mm² wires that are numbered and colour-coded.



7



Cables with different connection technologies are described in the manual “System cables and adapters” document 26-792.

8 Configuration (PG5 device configurator or device configuration)

The “Device Configurator” window (standard view)

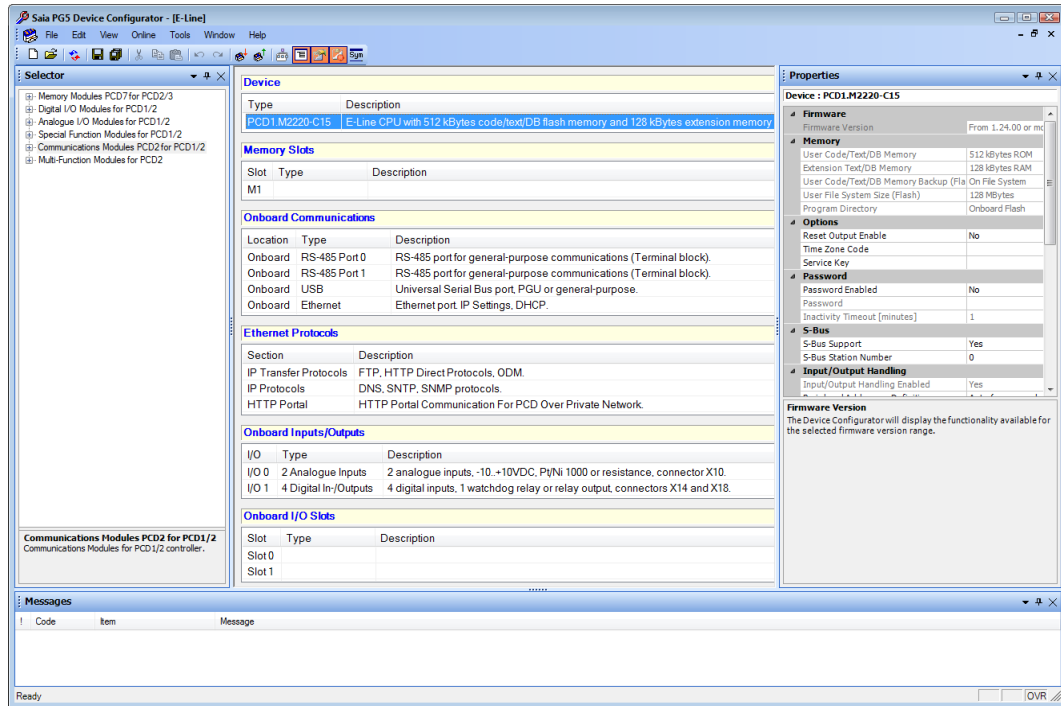

8

8.1 Requirement

The following description assumes that the user is familiar with the PG5 software.



Information on PG5 software, programming, tools etc. is included in the manual “26-732_DE_Benutzerhandbuch_PG5”



Manuals are never as up-to-date as the help pages in the respective tool of the PG5 packet.

8.2 General

This chapter describes how the Saia PG5® Device Configurator is used.

The Device Configurator defines:

- cyclic media mapping to enable a link between peripheral I/O module values and the device resources (e. g. PCD flags and register).
- direct access to programming instructions to read or transfer values from the peripheral module.



The I/O handling is always activated for the PCD1.M2220-C15 via direct access, there is no bit access command. The minimum access range is “byte”. It is therefore recommended to use media mapping to read or write all the I/O channels.

For further details, see the help text for the Device Configurator.

8.3 Device Configurator

8.3.1 Execution

Use the Device Configurator to set up hardware configuration, protocol devices and I/O handling.

Double-click “Device Configurator” in the project directory tree to start it.

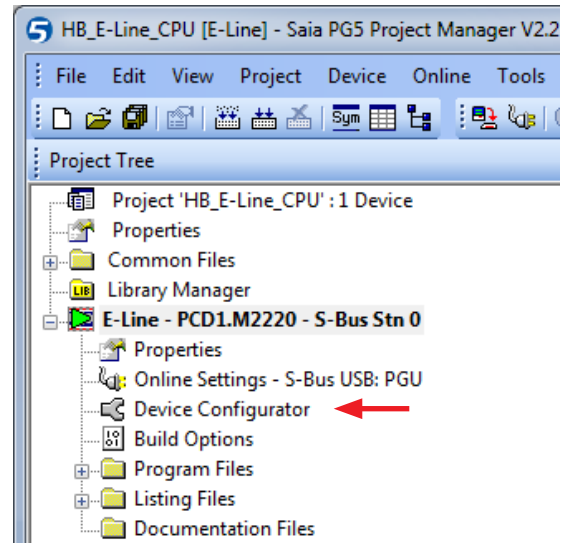

8

8.3.2 Help

Support for the Device Configurator can be found under the “Help” menu → “Help Topics”:

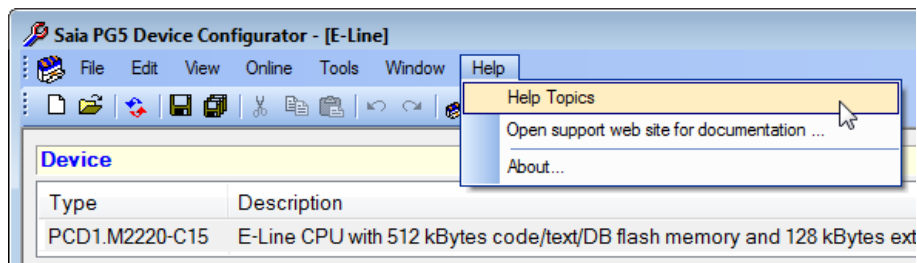

Click on one of the help topics:

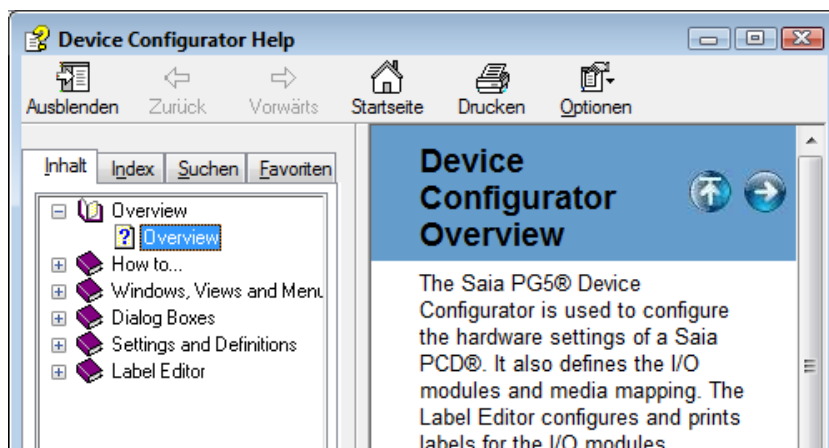

8.3.3 Media mapping view

Media mapping denotes the software assignment of digital and analogue I/O electronics to flags and registers using a table.

Example of a media mapping view

Slots / Symbols	Type	Address	Comments	Scope	Tags
PCD1.M2220-C15, E-Line CPU with 512 kBytes code/text/DB flash memory and 128 kBytes extension memory (RAM for Text/...					
I/O 0, 2 Analogue Inputs, 2 analogue inputs, -10...+10VDC, Pt/Ni 1000 or resistance, connector X10.					
S.IO.AnalogueInput	R [2]			Public	S_IO
IO.AnalogueInput0	R	S.IO.AnalogueInput + 0	Analogue input 0	Public	S_IO
IO.AnalogueInput1	R	S.IO.AnalogueInput + 1	Analogue input 1	Public	S_IO
S.IO.StatusAnalogueInput	R [2]			Public	S_IO
IO.StatusAnalogueInput0	R	S.IO.StatusAnalogueInput + 0	Status analogue input 0	Public	S_IO
IO.StatusAnalogueInput1	R	S.IO.StatusAnalogueInput + 1	Status analogue input 1	Public	S_IO

To consider the respective media mapping of the respective resources, you can open the relevant window in three ways:

8

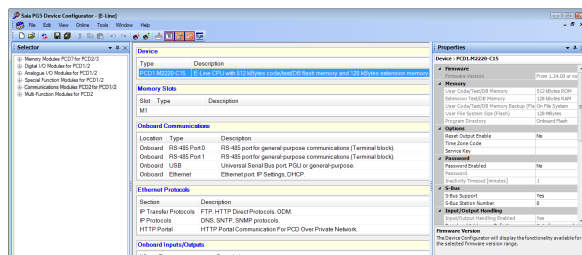

or

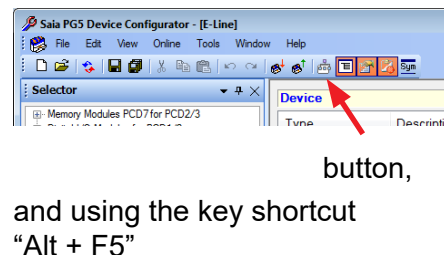

button,

and using the key shortcut "Alt + F5"

8.4 Digital inputs on-board

In the PG5 Device Configurator for PCD1.M2220-C15 > under...

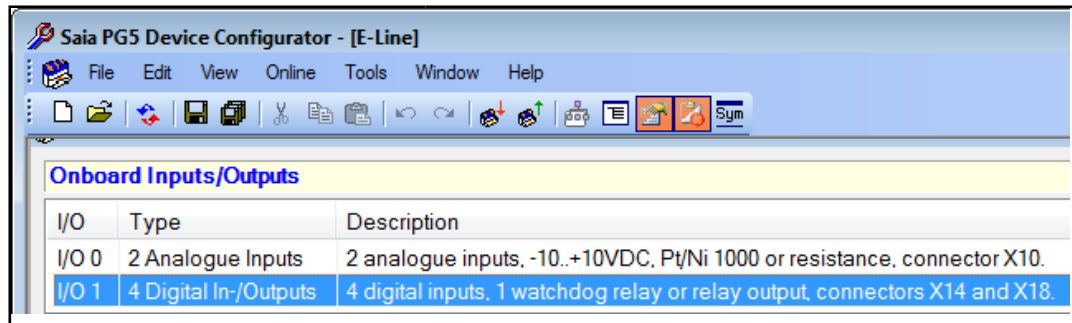

Properties overview

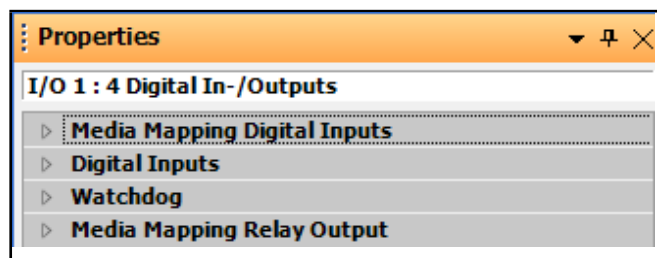

8

Media mapping yes/no

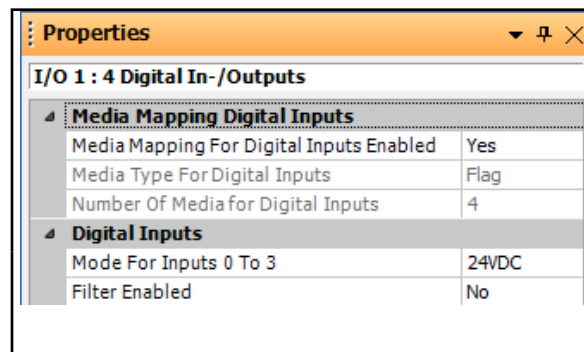

Specify VDC or VAC inputs.
Filter for DC: no = 0 ms or yes = 8 ms

mapping table for digital inputs

Slots / Symbols	Type	Address	Comments	Scope	Tags
PCD1.M2220-C15, E-Line CPU with 512 kBytes code/text/DB flash memory and 128 kBytes extension memory (RAM for Text/...					
I/O 0, 2 Analogue Inputs, 2 analogue inputs, -10..+10VDC, Pt/Ni 1000 or resistance, connector X10.					
I/O 1, 4 Digital In-/Outputs, 4 digital inputs, 1 watchdog relay or relay output, connectors X14 and X18.					
S.IO.DigitalInput	F [4]			Public	S_IO
IO.DigitalInput0	F	S.IO.DigitalInput + 0	Digital input 0	Public	S_IO
IO.DigitalInput1	F	S.IO.DigitalInput + 1	Digital input 1	Public	S_IO
IO.DigitalInput2	F	S.IO.DigitalInput + 2	Digital input 2	Public	S_IO
IO.DigitalInput3	F	S.IO.DigitalInput + 3	Digital input 3	Public	S_IO

8.5 Analogue inputs on-board

I/O	Type	Description
I/O 0	2 Analogue Inputs	2 analogue inputs, -10..+10VDC, Pt/Ni 1000 or resistance, connector X10.
I/O 1	4 Digital In-/Outputs	4 digital inputs, 1 watchdog relay or relay output, connectors X14 and X18.

Properties

Properties

I/O 0 : 2 Analogue Inputs

- Media Mapping Analogue Inputs
- Media Mapping Status/Diagnostic
- Analogue Input 0
- Analogue Input 1

8

Mapping device for values, status or diagnosis

Properties

I/O 0 : 2 Analogue Inputs

- Media Mapping Analogue Inputs**
 - Media Mapping For Inputs Enabled: Yes
 - Media Type For Inputs: Register
 - Number Of Media For Inputs: 2
- Media Mapping Status/Diagnostic**
 - Media Type For Status/Diagnostic: Register
 - Number Of Media For Status/Diagnostic: 2
- Analogue Input 0**
 - Filter Analogue Input 0: Off
 - Input 0 Range: Voltage Input
 - Minimum Value Input 0: -10000
 - Maximum Value Input 0: 10000
- Analogue Input 1**
 - Filter Analogue Input 1: Off
 - Input 1 Range: Voltage Input
 - Minimum Value Input 1: -10000
 - Maximum Value Input 1: 10000

Channel device and scaling information



Filter: Average value from the last 16 values.

Mapping table for analogue inputs

Media Mapping						
Slots / Symbols	Type	Address	Comments	Scope	Tags	
PCD1.M2220-C15, E-Line CPU with 512 kBytes code/text/DB flash memory and 128 kBytes extension memory (RAM for Text/...						
I/O 0, 2 Analogue Inputs, 2 analogue inputs, -10...+10VDC, Pt/Ni 1000 or resistance, connector X10.						
— S.IO.AnalogueInput	R [2]			Public	S_IO	
— IO.AnalogueInput0	R	S.IO.AnalogueInput + 0	Analogue input 0	Public	S_IO	
— IO.AnalogueInput1	R	S.IO.AnalogueInput + 1	Analogue input 1	Public	S_IO	

Mapping table for the status of the analogue inputs

Media Mapping						
Slots / Symbols	Type	Address	Comments	Scope	Tags	
PCD1.M2220-C15, E-Line CPU with 512 kBytes code/text/DB flash memory and 128 kBytes extension memory (RAM for Text/...						
I/O 0, 2 Analogue Inputs, 2 analogue inputs, -10...+10VDC, Pt/Ni 1000 or resistance, connector X10.						
— S.IO.StatusAnalogueInput	R [2]			Public	S_IO	
— IO.StatusAnalogueInput0	R	S.IO.StatusAnalogueInput + 0	Status analogue input 0	Public	S_IO	
— IO.StatusAnalogueInput1	R	S.IO.StatusAnalogueInput + 1	Status analogue input 1	Public	S_IO	

8.6 Special function

8.6.1 Watchdog relay for monitoring or as relay output

A relay is installed in the PCD1.M2220-C15 that operates as a monitoring relay (watchdog) as standard. Its function is activated by the FBox of the same name in the user program.

Alternatively, the relay can be used as an output (changeover contact) that is controlled using flags.

For a description of the functions and configuration, see

3.9 Watchdog (relay)...

“3.9.1 ... as a watchdog function”

“3.9.2 ... as a relay output”

8

Connection assignment, see

“6.1.4 Digital output” > “Connection assignment for the watchdog function”

> “Connection assignment for the relay output”

9 Maintenance

9.1 Maintenance-free





PCD1.M2220-C15 controllers are maintenance-free.

PCD1-CPU's do not contain parts that can be replaced by the user. If hardware problems arise, please return the components to Saia-Burgess Controls AG (see the chapter Appendix for the address).

A Appendix

A.1 Symbols

A.1.1 Note:

	In the operating instructions, this symbol indicates further information in these instructions or in other instructions or technical documents. A direct link to these documents is generally not provided.
	Instructions with this character must always be complied with.

A.1.2 Connection descriptions

Symbol	Description	Function
⊥	GND	ground
⊥D	DGND	digital ground
⊥A	AGND	analogue ground
⊥S	SGND	signal ground
⊥		earth
a, b, ...		alphanumeric index by different grounds

A

A.2 Definition of serial interfaces

A.2.1 RS-485

Signals to RS-485

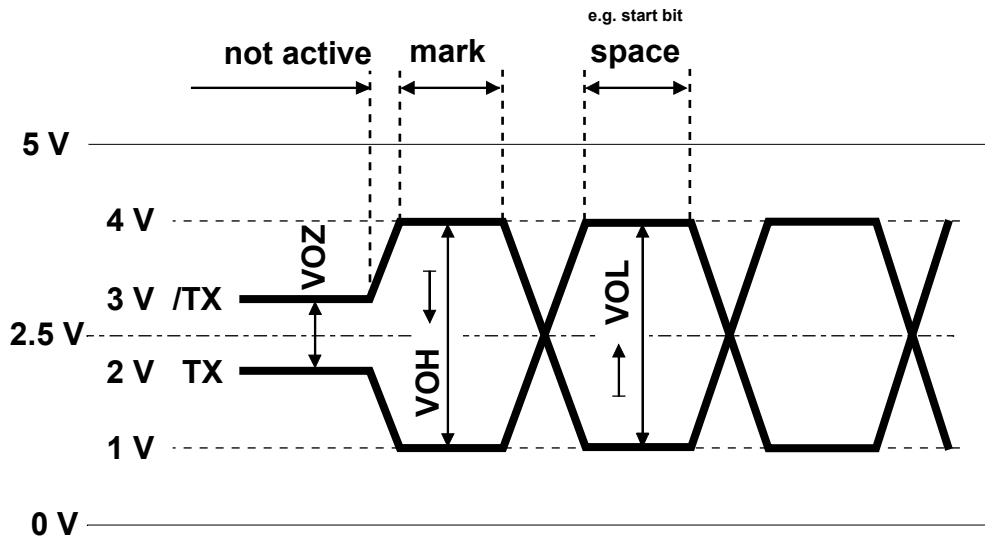

VOZ = 0.9V min.

VOH = 1.5V min. (with load) ... 3.6V max. (without load)

VOL = -1.5V min. (with load) ... -3.6V max. (without load)

Signal type	Logical status	Polarity
Data signal	0 (empty) 1 (character)	RX-TX positive on /RX-/TX /RX-/TX positive on RX-TX



Not all manufacturers use the same connection configuration, so users may have to cross the data lines



To guarantee an error-free operation of a RS-485 network, the network should be terminated at both ends. Cables and terminating resistors should be selected in accordance with the manual 26-740 "Installation components for RS-485 networks".

A.3 Installation regulations and relay contacts

A.3.1 Installation regulations for switching extra-low voltage

For safety reasons, max. voltages of 50V may be switched on this module.

The safety standard relating to the air and leakage current distances between adjacent channels is not stated for this module for higher voltages (50...250V).

It should be noted that all connections to the relay contacts of the module... A250 must be connected on the same circuit, i.e. only 1 phase for each module is permitted. The individual load circuits can however be secured individually again.

A.3.2 Installation regulations for switching low voltage

For safety reasons, the extra-low voltage (up to 50V) and low voltage (50...250V) may not be connected to the same module.

If a module from Saia PCD® Systems is connected to low voltage (50... 250V), components that are approved for low voltage use must be used for all elements that are electrically connected to this system.



When using low voltage, all connections to the relay contacts of the module ...A200 must be connected on the same circuit, i.e. only 1 phase for each module is permitted over 1 shared fuse. The individual load circuits can however be secured individually again.

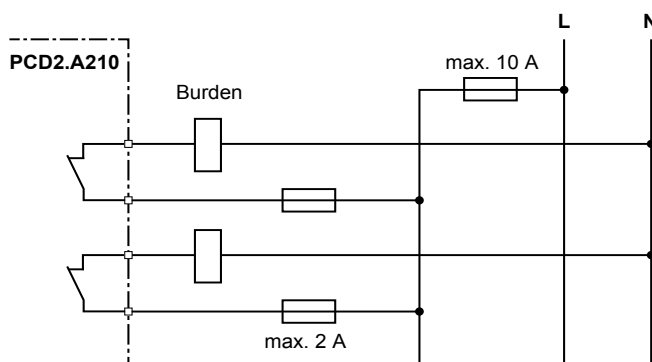
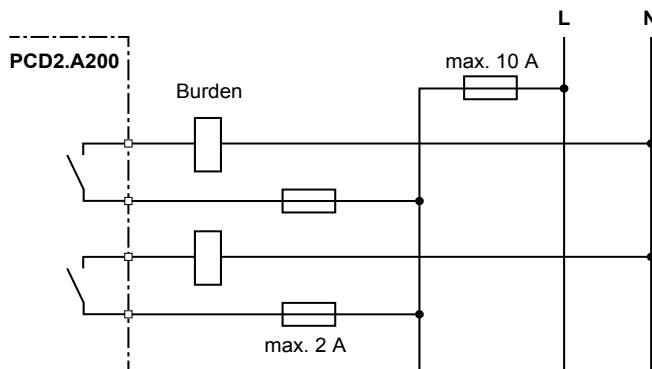

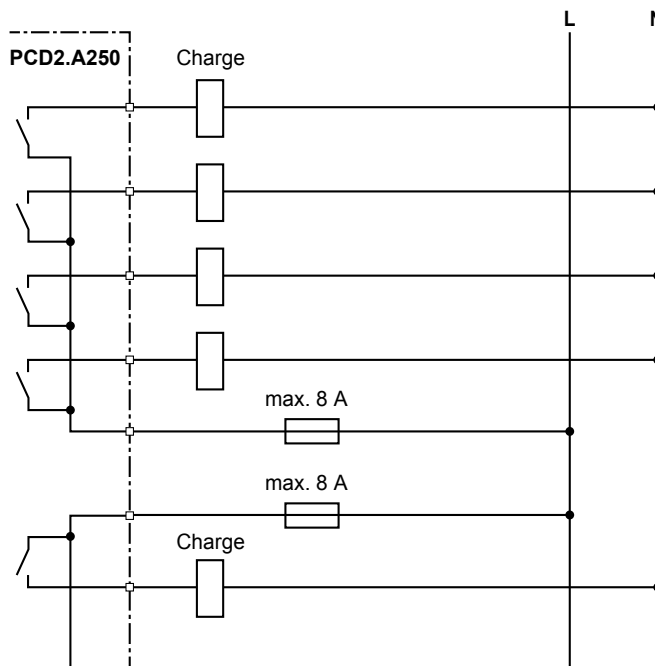
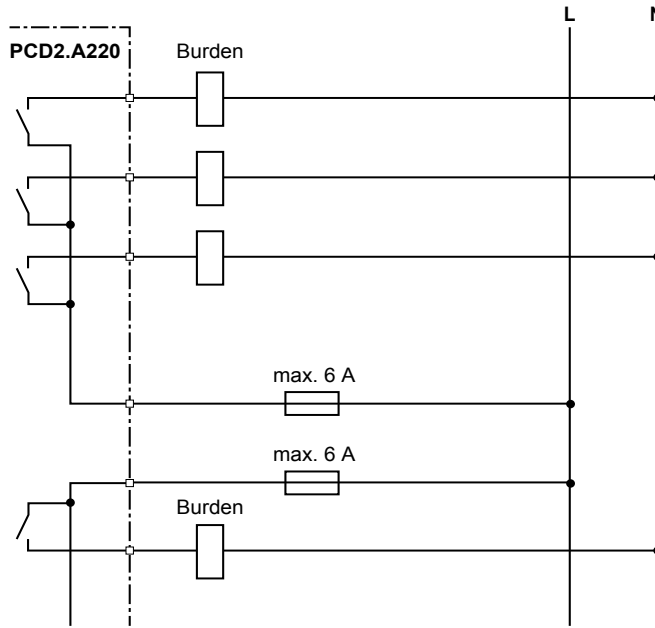

A.3.3 Switching inductive loads

Due to the physical properties of the inductance, noiseless shutdown of the inductance is not possible. These interferences must be minimised as much as possible. Regardless of whether the Saia PCD® is immune to these interferences, other devices may still be impaired.

It should also be noted that, as part of EU standard harmonisation, the EMC standards have been valid since 1996 (EMC Directive 89/336/EC). For this reason, two principles can be observed:

- THE SUPPRESSION OF INDUCTIVE LOADS IS ABSOLUTELY NECESSARY!
- INTERFERENCE SHOULD BE ELIMINATED AT THE INTERFERENCE SOURCE IF POSSIBLE!

The relay contacts on the existing module are wired. It is nevertheless recommended to install a suppressor on the load.

(Often available as standard components for standardised gates and valves).

When switching DC voltage, it is highly recommended to install a freewheeling diode over the load. This is also the case even if theoretically a resistive load is switched. There is always an inductive share in practice (connection cable, resistor coil, etc.). Please note that the shutdown time is extended here.

(T_a approx. $L/RL * \sqrt{RL * IL/0.7}$).

The transistor output modules are recommended for DC voltage.

A.3.4 Specifications of the relay manufacturer about the dimensioning of the RC elements

Contact protection circuits:

The purpose of the contact protection circuits is the suppression of the switching arcs ("switching sparks") and thus achieving a longer service life of the contact pieces. Each protection circuit may exhibit advantages and disadvantages. For arc quenching using RC elements, see the figure opposite.

When shutting down load circuits with inductive components (e.g. relay coils and magnet windings), an overvoltage (self-induction voltage) can arise which may be many times higher than the operating voltage and jeopardise the isolation on the load circuit due to the current interruption at the switching contacts. The initial sparks that arise from this lead to rapid wear on the relay contacts. For this reason, the contact protection circuit is particularly important for inductive load circuits. The values for the RC combination can also be determined from the diagram opposite, however the overvoltage (e.g. to be measured with an oscilloscope) arising from the current interruption for the voltage U is to be applied. The current must be calculated based on this voltage and the known resistance at which this was measured.

Only anti-interference capacitors in accordance with VDE 0565 T1 class X2 may be used in suppressors. These capacitors have a high switching capability and are designed for particularly high switching overvoltages. Direct operation on the mains voltage is also possible.

The resistors used must withstand high voltages (pulse strength). Voltage flashovers can arise on the production-related coil cut particularly for low-resistance values. Fixed carbon resistors are therefore used for suppressors in particular. Enamelled wire resistors, however, or cement resistors with a large coil pitch are also suitable.

Dimensioning aid:

The value for C results directly from the current to be switched. The value for the resistance R is calculated by drawing a line through the corresponding points of the I and U curve and the resistance is read at the point of intersection with the R curve.

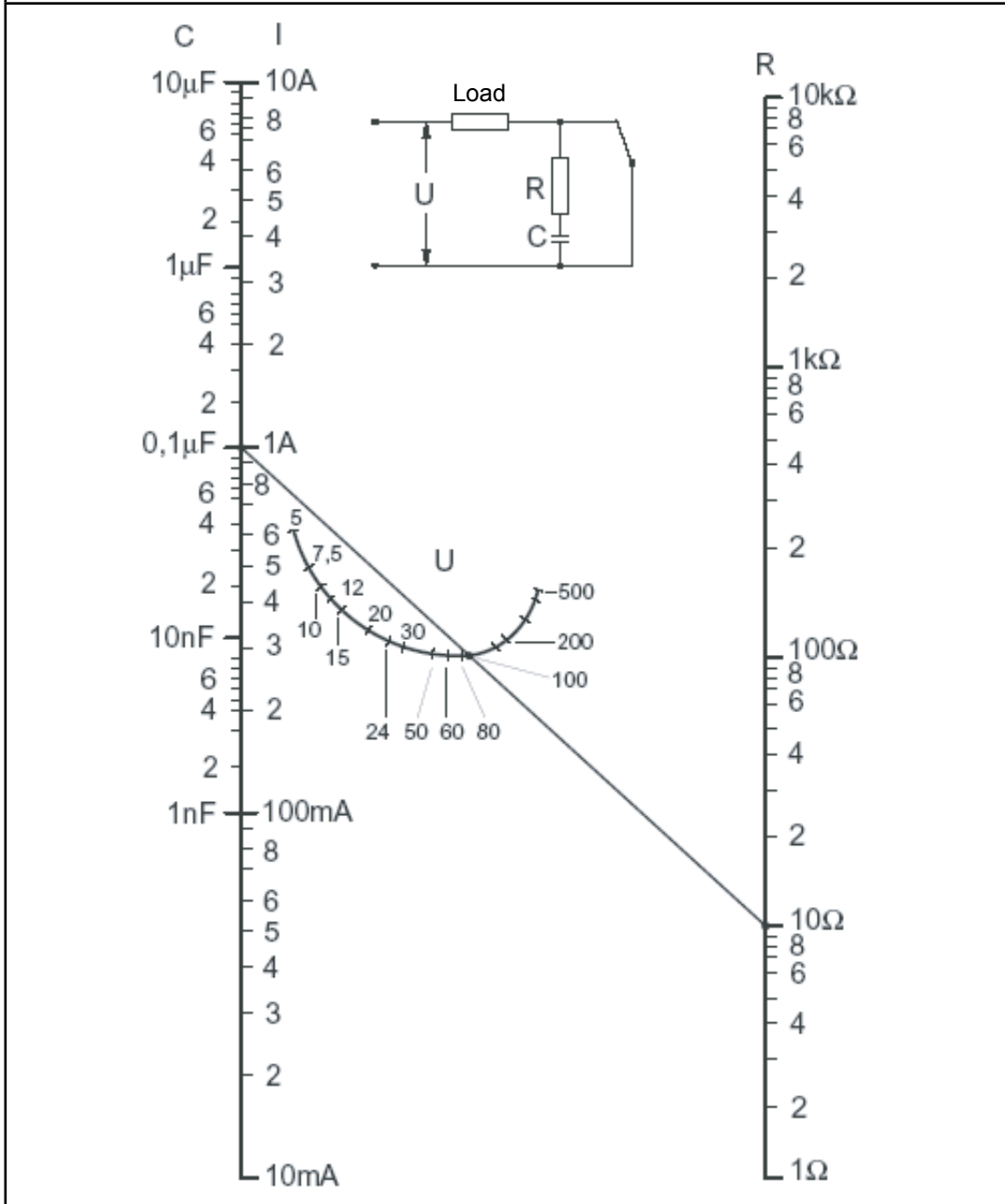

Example:

U = 100V I = 1A

C is therefore 0.1 μF

R = 10 Ω (point of intersection with R-scale)

A.4 Abbreviations

Ni	Element: Nickel (temperature sensors made of nickel) Temperature coefficient $\alpha = 6.0 \cdot 10^{-3} \text{ [K}^{-1}\text{]}$
NTC	Thermistor: Temperature sensors with negative temperature coefficient
Pt	Element: Platinum (temperature sensors made of platinum) Temperature coefficient $\alpha = 3.92 \cdot 10^{-3} \text{ [K}^{-1}\text{]}$
PTC	PTC resistor: Temperature sensors with positive temperature coefficient

A.5 Glossary

AWL	Statement list (programme code line for line)
Backup	Data backup on second data carrier.
Basic address	First numeric address of the IO module slot.
Buffer battery	Retention of the memory content and continuation of the clock after the power supply has been switched off
Builder	Combines different work steps to load a programme if it is OK in the PCD.
Compiler	A compiler is a program that compiles the source text of a program in a string that can be understood by the target computer.
CPU	Central Processing Unit Here the main housing with central unit is designed for the Saia PCD® family.
Device	Device → controller (part of a project in the PG5® Project Manager).
Download	Fig. "DnLd" → Save data in PCD
Element	Here, the inputs and outputs, flag, register, counter, timer, etc. are designed for the Saia PCD® family.
Flash memory	Digital, non-volatile memory. It retains its data without any current.
FRAM	Digital, ferroelectric, non-volatile memory. It retains its data without any current.
IL	Instruction list (AWL programme code line for line)
Linker	After the compiler has done its work, the linker merges the individual data for a programme.
LIO (Local Input Output)	Inputs/outputs on the CPU board (on-board).
Media	This indicates inputs/outputs, flag, register, etc. in the PCD family.
Media mapping	Media mapping is the software assignment of digital and analogue I/O electronics to flags and registers using a list.
Module	Carrier cards for input/output electronics with suitable connection technology.
Module holder	This specifies CPU, LIO or RIO devices that can hold IO modules.
Motherboard	Main board (CPU)
NT	New technology → subsequent generation of the first PCD generation.
On-Board	Denotes as much as permanently installed "on the CPU motherboard".
Parse	A parser is a program which, in computer engineering, is responsible for the decomposition and conversion of any input (text, e.g. AWL) into a format useful for further processing.
PGU	Programmable Unit
PLC	Process Logic Controller
Port	Interface description
PWM	PWM stands for Pulse Width Modulation. Pulse width modulation works with a constant pulse rate and a constant pulse amplitude, only the pulse width is variable. Because the pulse rate is constant, but the pulse width changes, the pulse duty factor changes. With a PWM output, it is possible to output analog values without expensive A/D converters.
RAM	Random Access Memory → digital, volatile RAM of the computer. Retains data without a power supply.

Resources	Resources → Inputs/outputs, flag, register, counter, timer, etc.
Restore	Load saved data from the data carrier.
RIO	Remote Input Output → Inputs/outputs on module carriers that can be accessed by the CPU via bus lines.
ROM	Read only memory → digital ROM, retains data without a power supply.
SD card	Secure Digital Memory Card → digital memory card, retains data without a power supply.
Slot	Slot for memory IO modules.
SPM	Saia PG5® Project Manager, main programme of the Saia PG5® software packet.
SuperCap	Electronic component (capacitor) that can supply power for a short time. Retention of the memory content and clock function after switching off the power supply.
Terminated	Electrical reflections at the line ends are prevented using termination (e.g. with terminating resistors).
x, xx or xxx	“x” in the product description stands for a number 0... 9. In the following case, an additional two-digit number, i.e. PCD1.M2220-C15 = e.g. PCD1.M2220-C15.

A.6 Contact

Saia-Burgess Controls AG

Bahnhofstrasse 18
3280 Murten, Switzerland

Telephone Headquarters..... +41 26 580 30 00

Telephone SBC Support +41 26 580 31 00

Fax..... +41 26 580 34 99

E-mail Support: support@saia-pcd.com

Support website: www.sbc-support.com

SBC website: www.saia-pcd.com

International agencies &

SBC subsidiaries: www.saia-pcd.com/contact

Postal address for customers to return purchases in Switzerland:

Saia-Burgess Controls AG

After Sales Service
Bahnhofstrasse 18
3280 Murten, Switzerland

A