

PCD3.W605

Analog output module, 6 channels, 10 bit, 0 ... 10 V, galvanic isolation to the CPU

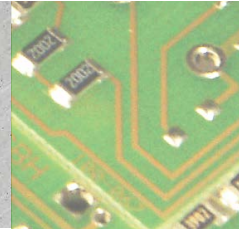

Fast output module with electrical isolation from the CPU for universal use with 6 channels each with 0 ... 10 V voltage and 10 bit resolution.

Use of a fast on-board micro controller allows decoupling and relief of the CPU regarding intensive computing tasks, such as scaling and filtering of signal data.



PCD3.W605

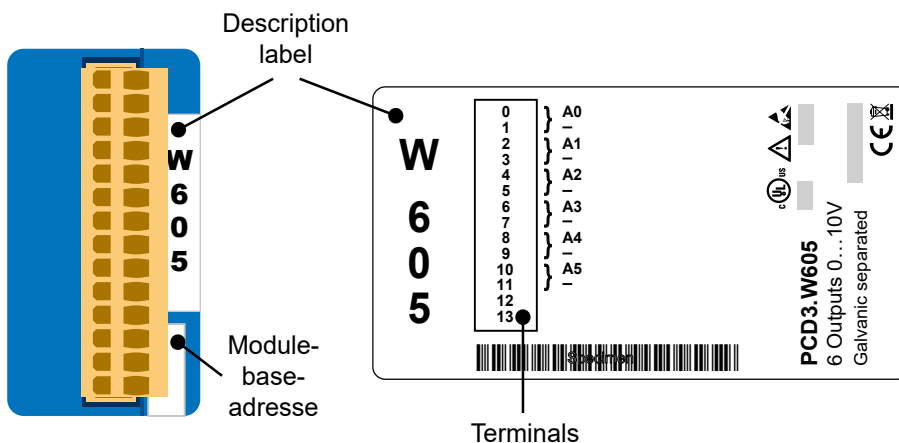

Technical data	
Number of outputs (channels)	6
Signal range	0 ... 10 V
Resolution (digital representation)	10 bits (0 ... 1023)
Resolution	10 mV
Galvanic separation	500 V, electrical isolation of outputs to CPU, channels themselves not separated
Short circuit protection	yes (permanent)
Time constant of output filter	typ. 1 ms
Load resistance	>3 kΩ
Cut off frequency	300 Hz
Accuracy at 25 °C)	±0.4 %
Temperature error (over temperature range 0 ... +55 °C)	±0.25 %, 100 ppm/K oder 0.01 %/K
Internal current consumption (from +5 V bus)	max. 110 mA (typ. 80 mA)
Internal current consumption (from V+ bus)	0 mA
EMC protection, according to standards	ENV 50 141, EN 55 022, EN 61000-4-2, EN 61000-4-4, EN 61000-4-5
Terminals	Pluggable 14-pole spring terminal block type E (4 405 4998 0) for Ø up to 1.5 mm ²

Indicators and connections

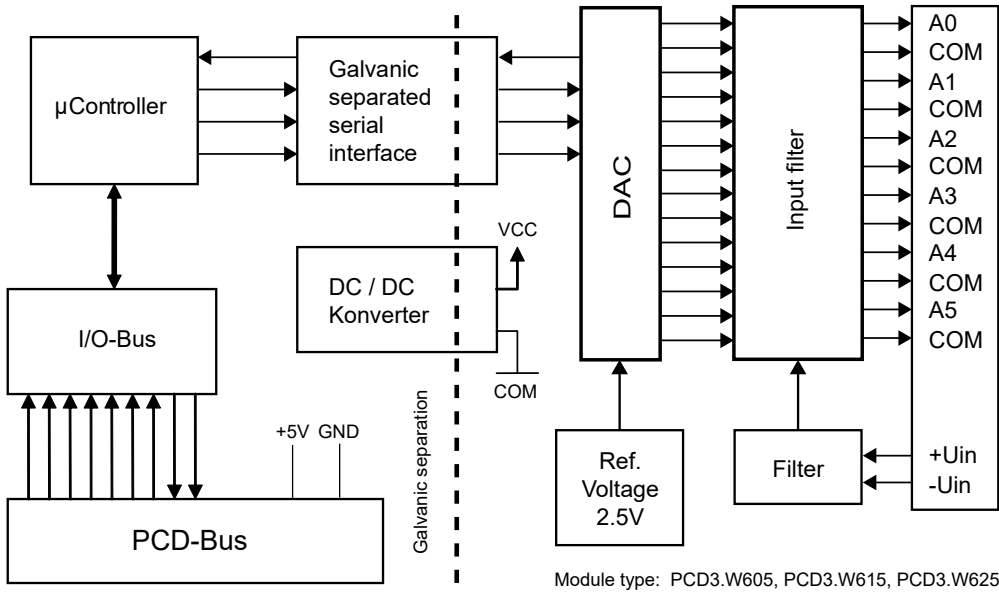

Block diagram



-  Galvanic separation of outputs to CPU, channels themselves not separated.
-  E/A-Module und E/A-Klemmenblöcke dürfen nur im spannungslosen Zustand der Modulträger gezogen oder gesteckt werden. Die externe Spannungsversorgung der Module + 24 V muss dabei ausgeschaltet sein.

Principle diagram of analog outputs

Output for 0 ... 10 V

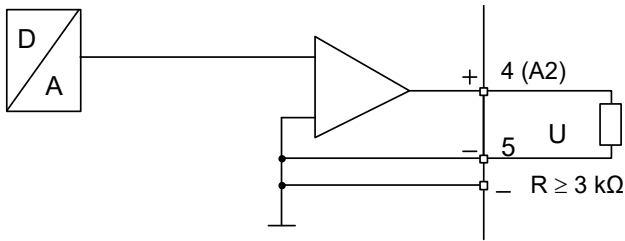

Connection concept (example)

The input signals are connected directly to the 14-pin terminal block. In order to couple as little interference as possible to the module via the lines, the connection should be made according to the principle explained below.

Connection for 0 ... 10 V

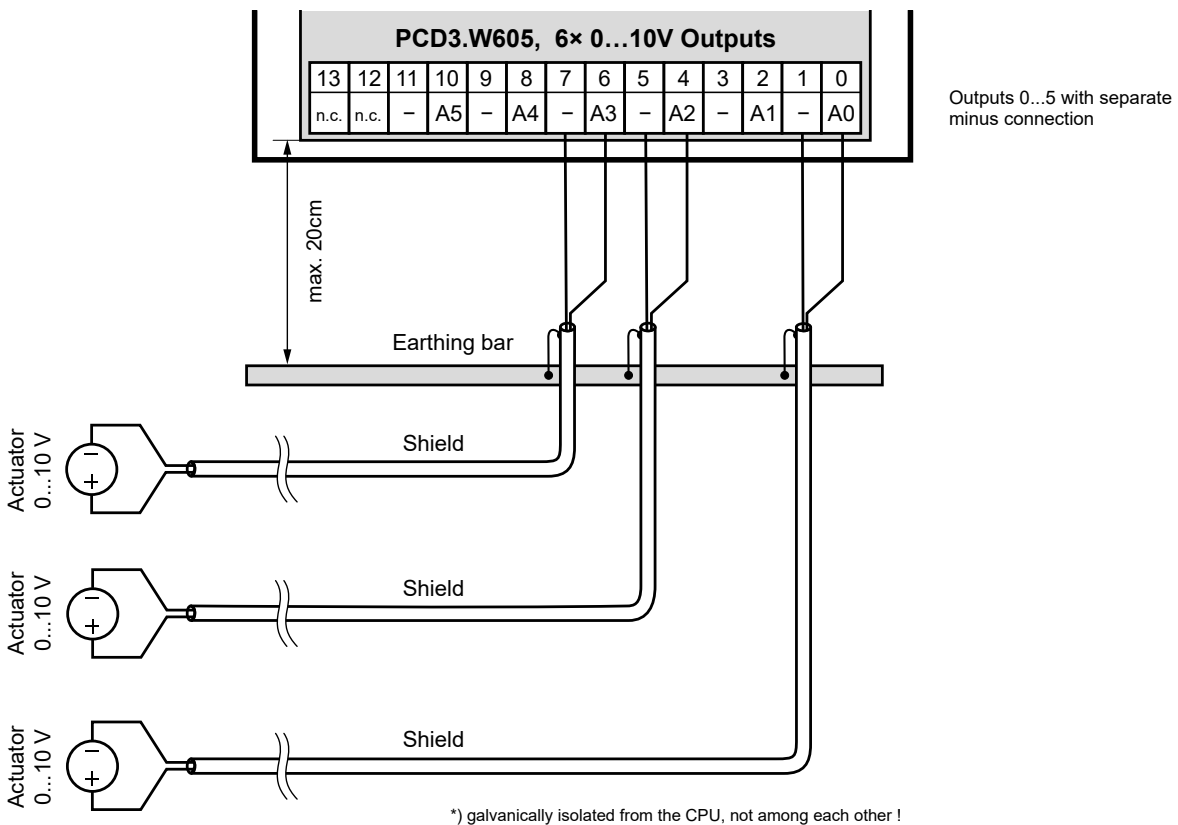

Notes on the output range

Balancing the offset and the amplification is done for the PCD3.W605 digitally by the μC . As there is no potentiometer, the output range has been slightly enlarged to cover maximum values even in the worst case.

Typical output range (without component tolerances):

-0.26 V ... +10.36 V (instead 0 ... +10 V)

This range is broken down on a 10 bit scale (1024 steps), as before.

The result is the following LSB resolution: 1 LSB = 10.38 μV

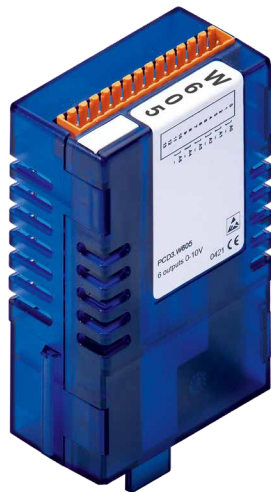

PCD3.W605



4 405 4998 0

Ordering information			
Type	Short description	Description	Weight
PCD3.W605	6 outputs 10 bit, electrically isolated, 0... 10 V	Analogue output module with galvanic isolation, 6 channels, 10 bits, 0... 10 V, connector type E (4 405 4998 0) included	80 g

Ordering information Accessories			
Type	Short description	Description	Weight
4 405 4998 0	Plug-in, E	Plug-in I/O spring terminal block, 14-pole up to 1.5 mm ² , labelled 0 to 13	13 g

**ATTENTION**

These devices must only be installed by a professional electrician, otherwise there is the risk of fire or the risk of an electric shock.

**WARNING**

Product is not intended to be used in safety critical applications, using it in safety critical applications is unsafe.

**WARNING - SAFETY**

The unit is not suitable for the explosion-proof areas and the areas of use excluded in EN 61010 Part 1.

**WARNING - SAFETY**

Check compliance with nominal voltage before commissioning the device (see type label). Check that connection cables are free from damage and that, when wiring up the device, they are not connected to voltage. Do not use a damaged device !

**NOTE**

In order to avoid moisture in the device due to condensate build-up, acclimatise the device at room temperature for about half an hour before connecting.

**CLEANING**

The device can be cleaned in dead state with a dry cloth or cloth soaked in soap solution. Do not use caustic or solvent-containing substances for cleaning.

**MAINTENANCE**

These devices are maintenance-free.
If damaged during, no repairs should be undertaken by the user.

**GUARANTEE**

Opening the module invalidates the guarantee.



Observe this instructions (data sheet) and keep them in a safe place.
Pass on the instructions (data sheet) to any future user.

**WEEE Directive 2012/19/EC Waste Electrical and Electronic Equipment directive**

The product should not be disposed of with other household waste. Check for the nearest authorized collection centers or authorized recyclers. The correct disposal of end-of-life equipment will help prevent potential negative consequences for the environment and human health.



EAC Mark of Conformity for Machinery Exports to Russia, Kazakhstan or Belarus.

Sales and Service

For application assistance, current specifications, pricing, or name of the nearest Authorized Distributor, contact one of the offices below.

ASIA PACIFIC

Honeywell Process Solutions,
(TAC) hfs-tac-support@honeywell.com

Australia

Honeywell Limited
Phone: +(61) 7-3846 1255
FAX: +(61) 7-3840 6481
Toll Free 1300-36-39-36
Toll Free Fax:
1300-36-04-70

China – PRC - Shanghai

Honeywell China Inc.
Phone: (86-21) 5257-4568
Fax: (86-21) 6237-2826

Singapore

Honeywell Pte Ltd.
Phone: +(65) 6580 3278
Fax: +(65) 6445-3033

South Korea

Honeywell Korea Co Ltd
Phone: +(822) 799 6114
Fax: +(822) 792 9015

EMEA

Honeywell Process Solutions,
Phone: +80012026455 or
+44 (0)1344 656000

Email: (Sales)
FP-Sales-Apps@Honeywell.com
or
(TAC) hfs-tac-support@honeywell.com

AMERICA'S

Honeywell Process Solutions,
Phone: (TAC) 1-800-423-9883 or
215/641-3610
(Sales) 1-800-343-0228

Email: (Sales)
FP-Sales-Apps@Honeywell.com
or
(TAC) hfs-tac-support@honeywell.com

WARRANTY / REMEDY

Honeywell warrants goods of its manufacture as being free of defective materials and faulty workmanship. Contact your local sales office for warranty information. If warranted goods are returned to Honeywell during the period of coverage, Honeywell will repair or replace without charge those items it finds defective. The foregoing is Buyer's sole remedy and is **in lieu of all other warranties, expressed or implied, including those of merchantability and fitness for a particular purpose.** Specifications may change without notice. The information we supply is believed to be accurate and reliable as of this printing. However, we assume no responsibility for its use. While we provide application assistance personally, through our literature and the Honeywell web site, it is up to the customer to determine the suitability of the product in the application.

Specifications are subject to change without notice.

For more information

Learn more about ControlEdge PCD, visit our website
www.honeywellprocess.com/ControlEdgePCD or
contact your Honeywell account manager.

Honeywell Process Solutions

2101 CityWest Blvd, Houston TX 77042
Honeywell House, Skimped Hill Lane

Bracknell, Berkshire, England RG12 1EB UK
Building #1, 555 Huanke Road,

Zhangjiang Hi-Tech Industrial Park,
Pudong New Area, Shanghai 201203

©2020 Honeywell International Inc.

Document No. 51-52-03-93
Rev. 4.0
July 2020

Honeywell