

SBC System catalogue 2022 | 2023

Electronic instrumentation, control and automation
technology for machines, facilities and real estate



Contents

A

Products

A1	Automation stations	7
A2	HMI Visualization and operating	85
A3	Room controllers	101
A4	Consumption data capture	117
A5	Accessories for automation technology	137

B

Basic systems

B1	SBC Software	153
B2	Communication & Interaction	187
B3	SBC S-Web: Visualisation, Trending, Alarming	217
B4	Room control	237

C

Appendix

C1	Status: Product launch and availability	247
C2	Abbreviations	251
C3	Type listing	253

This catalogue presents the current product range for the automation of technical infrastructure. It includes facilities for energy production and distribution, water supply, telecommunications, transport networks and HVAC facilities in buildings.

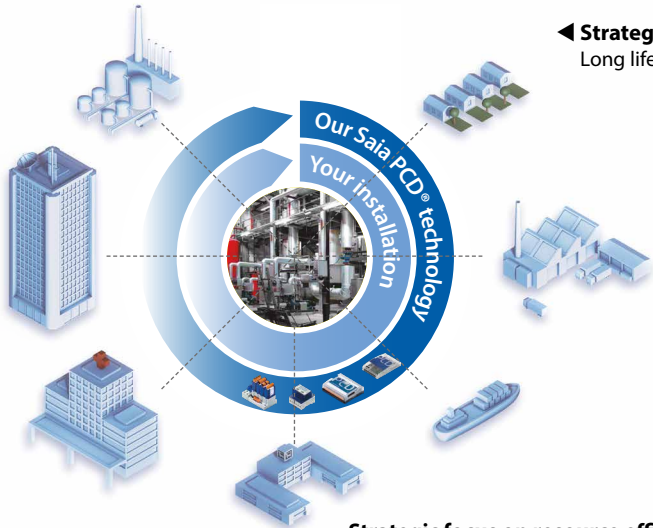

◀ **Strategic focus on primary systems with SBC technology**
Long lifecycle, adaptable, expandable

This catalogue does not cover all the products supplied by Saia Burgess Controls. An aware choice based on relevance was made for as many of our customers as possible.

This resulted in the following focus topics:

- ▶ Instrumentation, control and automation (ICA) technology of primary installations
- ▶ Increased efficiency when using natural resources
- ▶ Technical integration and automation of buildings

▶ **Strategic focus on resource efficiency**

Record, display and control the consumption of electricity, water, gas, heating, etc. with SBC S-Monitoring Systems. Suitable for use everywhere where technology has to be easily and reliably integrated into operations but is to remain flexible and expandable – from residential homes to industrial facilities.

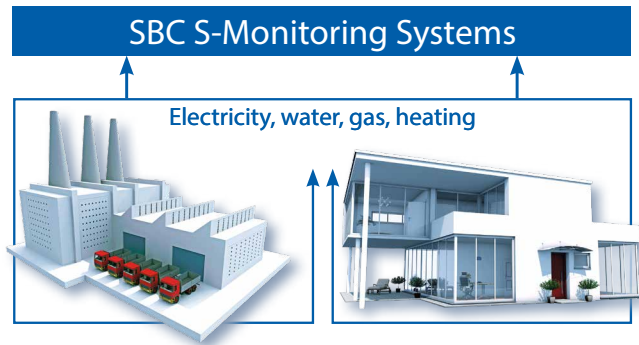

Our catalogue does not feature products with a lifecycle likely to end in a few years' time. We no longer recommend these "end of life" products when planning new projects. They will therefore no longer be listed in the manual. A list of all the available SBC products can only be found in the current price list. Here you will also find products which are specially designed for the automation of industrial production machines

You invest, operate, manage...

The catalogue provides an introduction on how to understand and be able to assess for yourself the qualities and properties of the ICA/automation technology you have integrated and/or planned. You can see which technical capabilities exist for operating infrastructure objects more cost-effectively and with less effort. You can recognize how you can avoid dependencies which are disadvantageous to your business. You can find products "Made for Lean Automation Technology" which are designed to give you more peace of mind.

You plan, advise, calculate...

You can find the technical basis for consulting, engineering and invitations to tenders. You can recognize how Saia PCD technology can help you to achieve maximum flexibility in project implementation and the following optimization phase. Maximum flexibility helps you to deal with the 2 basic constants of the project business better and more easily. These include:

- a) You are lacking important information and requirements in the planning phase.
- b) The actual construction design deviates from your plan. Despite this, everything should be finished on time and within budget.

You install, implement and provide service...

Here you can find the general technical principles for mounting and cabling SBC device technology. You can understand how applications are created with SBC S-Engineering software tools and how they can be changed in the lifecycle. You can recognize which device, which software tools and application modules are suited to an invitation to tender or project description.

How can the SBC System Catalogue help you?



Shared objectives

Being able to understand and assess products and their integration into systems is essential. Knowing what objectives they were created to achieve helps accomplish this. These objectives should largely be identical to those of operators, planners and integrators of ICA systems.

Shared objectives bring everyone together – just as the shared methods and values of the companies involved make collaboration easier and ensure success. The following two pages provide a short overview of this.

Technical cornerstones

In order to achieve the shared objectives of operators and owners of automation systems, we need a suitable stable technical foundation. This foundation comprises 4 basic properties which are common to all Saia PCD controllers.

- 1 Modularity in hardware and function enables high flexibility and adaptability at any time during the lifecycle of 15...20 years.
- 2 Maximum portability: The project's application software can be ported over all device classes and device generations throughout the lifecycle; even by the owner/operator alone.
- 3 Complete openness in communication. All device functions and data can be seen from the outside and used. Complete openness also in licensing the SBC software tools, because SBC software tools are available to anyone.
- 4 Standard technology only: The ICA functions of Saia PCD devices are implemented using standardized technology that is in common use and is recognized around the world (web + IT). We do not use proprietary technologies. Saia PCD S-Bus is the exception. We need this in order to get right into the core of the Saia PCD devices, e.g. debugging.

Bus technology usable with Saia PCD control devices
Other protocols can also be implemented later as a PLC program

 BACnet

Modbus

LONWORKS[®]
Networks

Profibus

M-Bus

DALI

KNX

enOcean[®]

MP-BUS[®]
MP-BUS COMPATIBLE





About us ...



Control systems

Saia-Burgess Controls AG, or SBC, is based in a bilingual (German and French) part of western Switzerland – the locality which is home to companies with a global reputation and to leading schools and universities in the field of technology. Saia Burgess Controls is a wholly-owned subsidiary of Honeywell International Inc. and operates according to the “bottom up” principle: the needs of the grassroots are defined and integrated into the development and manufacturing process. The company has developed and marketed electronic components and

measurement and control systems since 1950. The products are distinguished by an extremely long service life. They are used in heating, ventilation and climate control, energy management and water systems. A further important pillar of the company is OEM production. SBC products are always fit for purpose and are guarantors of technological progress.

Our mission

Development, production and sale of industrial-grade electronic components and systems for control/automation engineering.



In the early days, Saia Burgess Controls manufactured mainly electronic timers. The spectrum of use extended from house installations to machine technology.

At the end of the seventies, Saia Burgess Controls became a pioneer in the field of programmable logic controllers (PLCs), known and used long-term under the Saia® brand name. In parallel with the component business, Saia Burgess Controls grew to become a supplier of measurement and control technology systems.

The year 2006 saw the start of the product line for fully integrated bus compatible electronic energy meters.



In the same year, Saia Burgess Controls launched the world's first completely web-based touch-panel for automation.

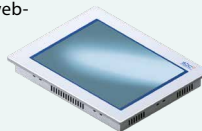

In 2010, with the complete redesign of the Saia PCD1, the smallest device series joined the Saia PCD3 and Saia PCD2 in being fully modernised. The 3rd generation of Saia PCD control devices is now complete. This is characterised by the following equation:

Saia PCD® = PLC + IT + Web
Seamless integration of world renowned open technologies for web and IT on freely programmable, industrial electronics with the same quality and life cycle as the robust, industrial PLC.

Value and culture of a PLC company

When they use our products customers gain value added in the form of sustainable earnings. For this reason, we develop products with a long life cycle of problem-free, reliable operation. Installed products can be adapted to changing needs at any time. Investments made by the customer are lasting and not constantly subject to incompatibilities or forced and unwanted innovations. This is why we develop PLC-based technology, with its sustained customer benefit and ease of upgrade. For more than 50 years, our company has remained true to these values.

Since application settings all too often fail to behave in accordance with the standards, we have made Saia PCD1, 2, 3 control technology more robust against interference than the CE standard requires. We set high standards for ourselves. This gives our customers greater security and peace of mind



Alongside the strict IEC 61131-2 PLC hardware standard, Saia PCD control technology also meets the stringent requirements of various testing authorities for marine engineering.



IEC EN 61131-2

This standard defines in 150 pages how electronic items should be developed and produced to satisfy PLC quality requirements. It ensures, among other things, that service is possible even without specialists. Look out for the extension “-2”. Many suppliers work only to PLC standard 61131-3. But that standard only defines the programming method type, regardless of the hardware/design quality. In addition, standard 61131-3 does not specify the portability of application software from one device series to another, nor from one hardware version to the next.



From bid phase to production and far beyond: All in-house



Product Development

Software, firmware and hardware developed in-house

Guaranteed product life cycle and compatibility for over 15 years

Faster and more reliable production of custom orders



Production

Two modern SMD lines with 560 feeder positions

Effective mounting capacity of 80,000 components per hour

Selective soldering machine for processing densely populated, critical boards

ICT, AOI and boundary scan test methods



Assembly

Production and assembly based on the "lean" principle

Direct final assembly in work cells downstream of the SMD line, no intermediate storage

A machine-assembled board becomes a finished product ready for dispatch, including packaging and documentation.



Logistics

▶ 75,000 order items

▶ 12,000 packages

▶ 1,000 sales items kept in stock

▶ Delivery reliability: >96%

▶ Delivery time:
80% of items within 48 hours



Training and Support

The aim is to achieve a high level of autonomy and efficiency for our customers.

Product support and training centres at every sales support location

Practical basic and advanced training facilities at the factory in Switzerland

View of lifecycle for Saia PCD® control equipment

Introduction phase
3-5 years

Product care phase
>10 years

Service phase
>5 years

18 years Saia PCD control device lifecycle < 25 years

Changeover phase

Program-compatible subsequent generation

Control and measurement electronics should have the same life cycle as the installation plant technology. During this cycle the technology must remain adaptable and expandable at all times; it should therefore be modular and in PLC quality.



The compatibility and free portability of system/machine software is safeguarded over an entire product generation of 18 to 25 years. This can only be achieved if we develop all the engineering software ourselves, and systematically use "interpreted program code". This approach requires rather more hardware resources, but allows user software to be portable across several controller generations.

Our customer base

The spread of our customers is a distinctive feature of our company.

More than 50% of our corporate turnover is achieved with "small" system integrators, who carry out infrastructure automation projects. At the other end

of the scale, we also develop and manufacture products for well-known international companies in electrical automation. Midway between the two are the production machine builders. Many of these supply HeaVAC and "energy" machines for infrastructure. In process

technology, Saia PCD controllers are found in machines for stoneworking, textiles, printing, assembly, etc. In the case of machine controllers, we have no specific industry focus but rather a customer focus. Target customers are manufacturers of production machines who value an economical and innovative controller technology that offers them ample room for their own added value and product differentiation. We provide our customers with individual adaptations to achieve maximum efficiency for their needs.

Customer support

We consider service to be an integral part of the sale price. As a result, our customers experience success and delight when using our products. For us, satisfaction is not an option or an "accessory", but part of the basic product. As a system manufacturer, our support expertise goes far beyond one single device. Our products are components and systems.

Lean automation support

The greatest benefits are achieved with minimum operating costs if the requirements profile of the user/operator is implemented as perfectly as possible in automation solutions. This profile only becomes clear in long-term operation and when there is good knowledge of the individual application. For this reason, people who implement and maintain the operational automation/ICA solution should be as close to the application as possible. SBC support is thus fully focused on achieving maximum autonomy and independence with high efficiency for system integrators, systems builders and operators. Saia Burgess Controls does not deal with the realization and maintenance of installed, fully operational automation/ICA solutions. A device manufacturer simply does not have the strategic starting position to be the best here.

Quality and performance of SBC support

The quality and performance of our support determines our success. We regularly have independent institutes assess our customers' satisfaction with the support service. The results of the survey are checked for credibility by authorities such as the German company TÜV Süd before publication.



Breakdown of sales Saia Burgess Controls :
 For us, revenue from service is of virtually no significance. We derive no profit from operator/owner problems and costs over the life cycle. SBC support is free of charge, because every device delivered includes support when needed.

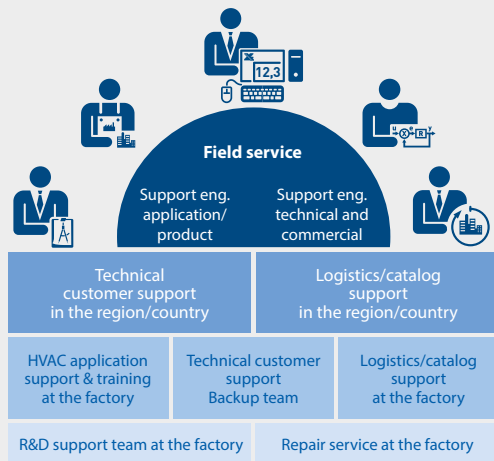

Support structure for SBC components and systems

Mission: The logistics support ensures that products from the factory can be delivered within a week to each (industrialized) place on earth.

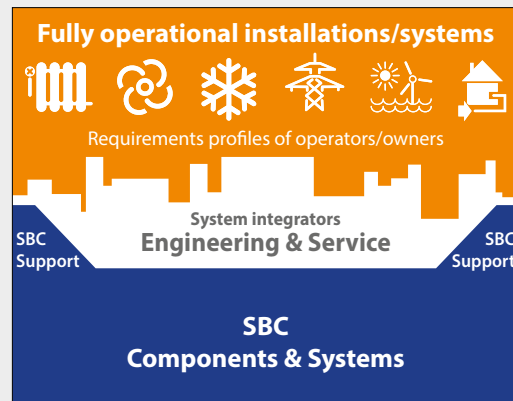

Our value contribution on the way to an installed and optimized ICA solution.

SBC support structure

The satisfaction and economic success of the operator/user when using SBC technology is influenced by many groups of people. For this reason, SBC support specifically supports everyone involved in the planning, implementation and operation of facility installations. Support engineers are available to the customer for advice and assistance. The field service support engineers are assigned to a support center in the country/region. Their employees are available to all interested parties by phone, e-mail and NetMeeting. Where the scope and type of local resources is not sufficient, there is a further factory support level in the background. Large training facilities for HeaVAC technology are also provided here. Online help is available 24 hours a day, 7 days a week at www.sbc-support.com.

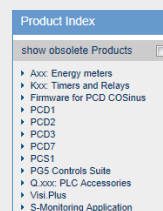

www.sbc-support.com

Online help is available 24/7.

A

Products

A1	Automation stations	7
A1.1	System description	8
A1.2	PCD3 – modular cartridge construction	19
A1.3	Standby System	37
A1.4	PCD2 – modular, expandable, compact CPU	45
A1.5	PCD1 – modular, expandable, compact CPU	59
A1.6	PCD1 E-Line – compact design for electrical distributors	69

A2	HMI Visualization and operating	85
A3	HMI Visualization and operating	101
A4	Consumption data acquisition	117
A5	Cabinet components	137

A1 Automation stations

Programmable for measuring, regulation and control devices. Modular series consisting of industrial quality CPU, I/O and communication modules with a service life that will last for decades.

The application software can be simply and reliably adapted and expanded throughout its service life. It can be used for all device series (Saia PCD1, 2 and 3).

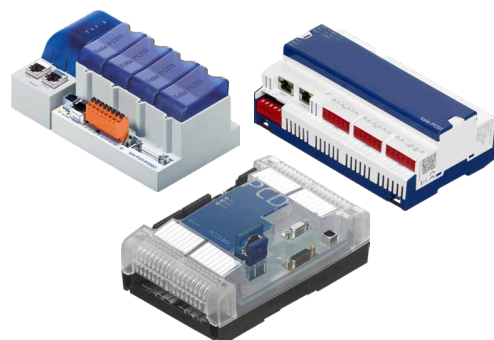

1.1 Basic system properties

Presentation of the Saia PCD COSinus control operating system – hardware structure – program execution – memory system and service capability.



Page 8

1.2 PCD3 – modular cartridge construction

Up to 1023 I/Os – up to 13 simultaneously operated communication interfaces.

- ▶ Saia PCD3.Mxx6x as high power CPU
- ▶ Saia PCD3.M5xxx as standard control device
- ▶ Saia PCD3.T66x remote I/O stations
- ▶ Saia PCD3.M3xxx as the most compact base unit
- ▶ Saia PCD3.M2 with dedicated I/O level and function



19

1.3 Standby System

Standby system for highly available automation solutions.

- ▶ PCD3.M6880 standby controller
- ▶ PCD3.T668 smart RIO for standby system



37

1.4 PCD2 – modular technology with a compact design

External dimensions independent of the type and number of the integrated hardware modules. Expandable system up to 1023 I/Os – up to 15 simultaneously operated communication interfaces.



45

1.5 PCD1 – modular, expandable, compact CPU

18 basic I/Os which can be expanded to max. 50 I/Os with 2 optional I/O modules – up to 8 simultaneously operated communication interfaces.



59

1.6 PCD1 E-Line – compact design for electrical distributors

E-Line product line for specific applications in very confined spaces.

- ▶ Programmable I/O modules
- ▶ I/O modules
- ▶ Communication modules and gateways



69

1.1 Saia PCD® System description

PLC + (Web + IT) = Saia PCD®

Saia PCDs combine PLC functionality with innovative web and IT technology in an industrial quality system. The basic equation Saia PCD® = PLC + (web + IT) means that the conventional automation pyramid is becoming an open, transparent structure.

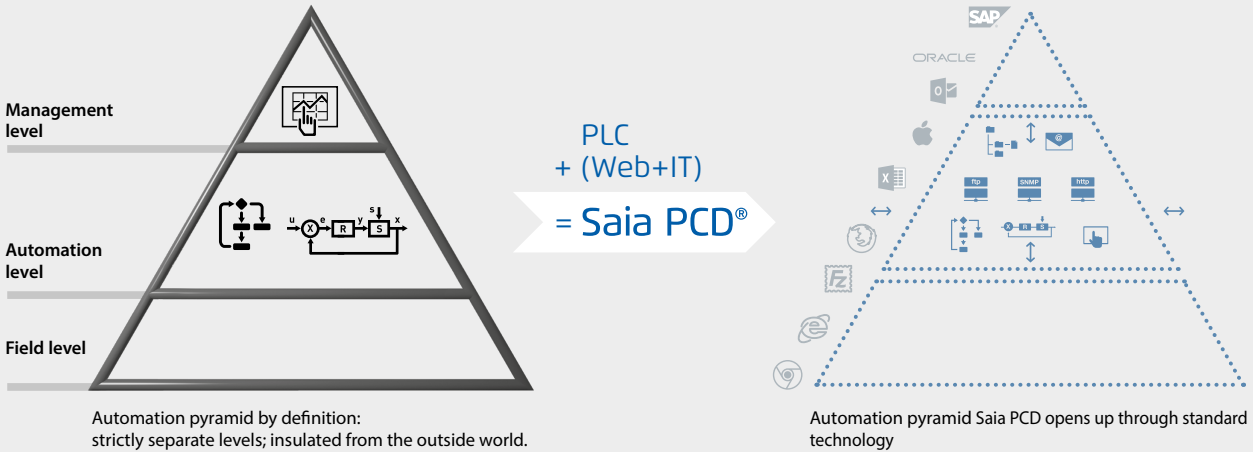

The Saia PCD system with its open technology stands for total transparency, combinability and openness. This applies between all the levels of the automation pyramid, the automation world and the actual operating environment of the user. To achieve this, all Saia PCD control and regulation devices generally include comprehensive web + IT functions. These functions do not require additional hardware and form an integral part of every device. Machines and systems can therefore be very easily integrated into the existing IT infrastructure.

The service life of Saia PCD®: Compatibility and portability guaranteed for all device types across generations.

We develop our products to provide customers with direct added value that enables them to generate sustainable revenue. This requires products with a long service life and flawless and reliable operation. Previously installed products must always be able to adapt to changing needs. Existing investments should not always be made obsolete by unwanted, forced innovations and incompatibilities. This is why we attach such great importance to PLC-based technology with its sustained customer benefit and ease of upgrade. Our company has remained true to these values for over 50 years. Moreover, we only use components that comply with industrial standards and which have a service life of at least 20 years.

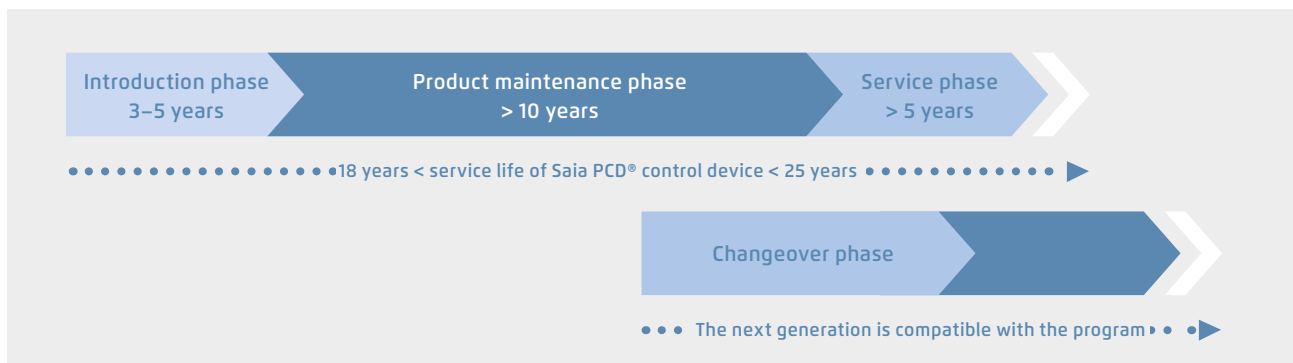

▲ Service life planning of Saia PCD® control devices. Enables maximum profitability of your investment in expertise and systems. Long service life without expensive reinvestment and no high service costs.



Standards

Saia PCD controllers comply with the IEC EN 61131-2 standard in terms of design and production quality. This standard defines in 150 pages how electronic items should be developed and produced to meet PLC quality standards. All the important topics for the applications are covered: From the environmental conditions (temperature, humidity, vibration), to functionality (fluctuations in the power supply, interruptions) and electromagnetic compliance depending on the area of application.

As application settings often fail to behave in accordance with the standards, our SBC control technology is more robust against interference than required by the CE standard. The majority of Saia PCDs are also approved for maritime applications, where increased demands are made on the devices.

The quality and robustness of the Saia PCD control technology is also evident in MTBF values, in the rates of returns from the field and in the feedback from our regular customer satisfaction surveys. See page 18 for more information on this topic.

Basic configuration of the Saia PCD® CPU modules

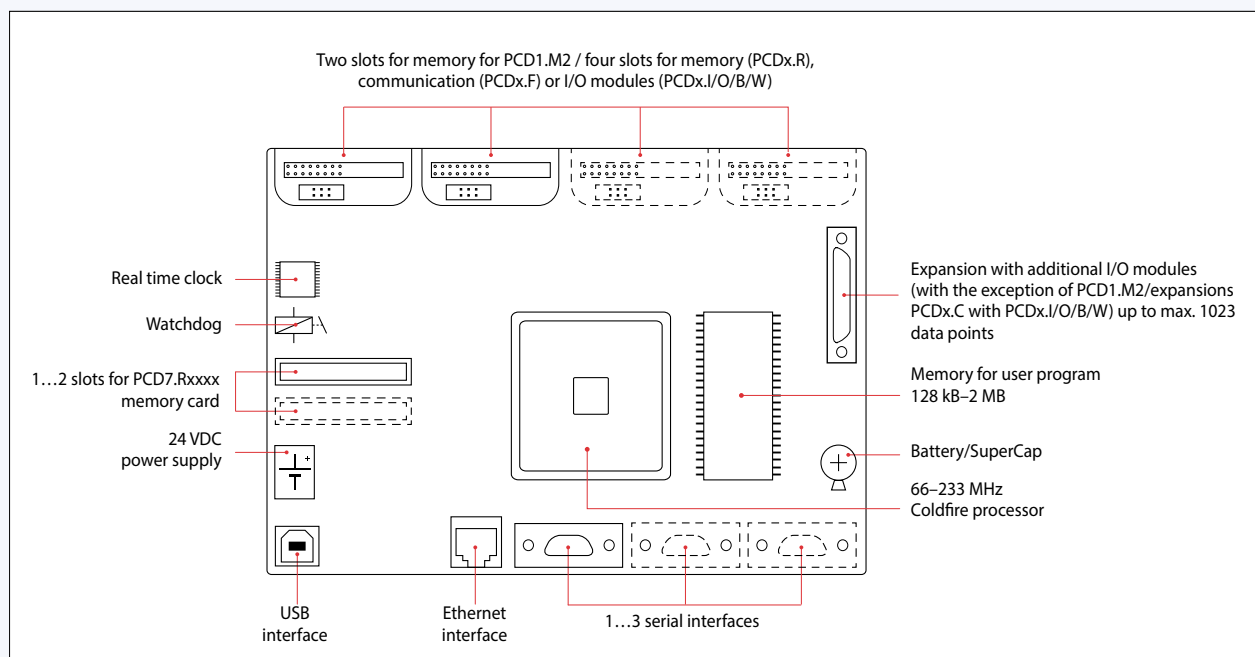

▲ Overview of the core elements of a Saia PCD controller

Saia PCD® hardware:

Common properties

- ▶ USB interface for configuration, programming and commissioning
- ▶ Ethernet interface with all the important web/IT protocols, including those for PG5 communication
- ▶ At least one onboard serial interface (Saia PCD3.M5/6: 3x)
- ▶ 24 VDC power supply
- ▶ Data remanence through battery and/or SuperCap
- ▶ Watchdog and fast interrupt inputs on the main CPU
- ▶ Slots for intelligent communication or memory modules
- ▶ Can be expanded in a modular way (except for Saia PCD1.M) up to 1023 data points

Saia PCD® COSinus – Control Operating System

We developed the core of the Saia PCD operating systems between 2001 and 2003 as part of a European cooperation project with Philips and Nokia. We then expanded the core and focused on an operating system for advanced, industry-quality measuring, control and regulation devices. A dedicated operating system for ICA technology – a control operating system (COS). Developed in-house and with all aspects fully covered.

Saia PCD COSinus connects user programs and various hardware

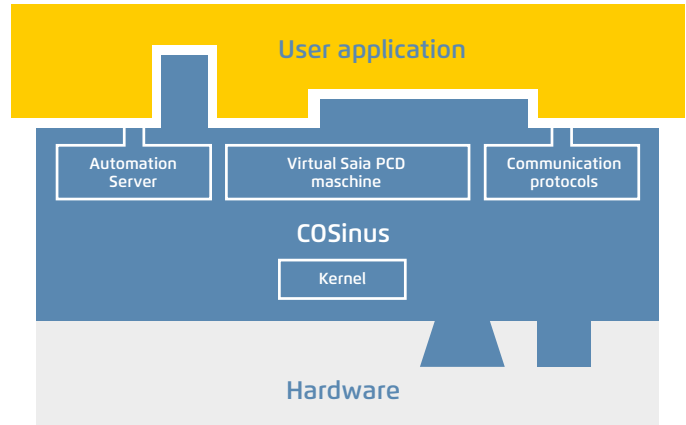

The main components of Saia PCD® COSinus

- 1 Multi-tasking kernel:** Abstracts the hardware, incl. I/Os and communication interfaces, provides basic multi-tasking functionality on which the program processing of Saia PCD programming is also based.
- 2 Virtual Saia PCD machine:** This is the logic machine that executes the PG5 programs. The virtual Saia PCD code is interpreted and guarantees that programs are always executed in a consistent manner on different PCD controllers. The three hubs of the PG5 application program are the following:
 - ▶ **Media:** Memory of the virtual PCD machine such as registers, flags, meters, etc.
 - ▶ **Program execution:** Program and organisation blocks, text, monitoring, error processing, memory management, etc.
 - ▶ **System functions:** Access to the hardware, I/Os, interfaces and drivers
- 3 Automation Server:** The Automation Server includes widely used web/IT technologies and ensures data exchange between users and automation solutions with no proprietary hardware or software required.
- 4 Communication protocols:** Various field and automation protocols such as BACnet®, Lon, Profibus, Modbus, DALI, M-Bus, and many others.

Why COSinus?

The control operating system (COS) ensures that customers' application software will always operate on all platforms, is portable across device generations and expandable over several decades. Hardware and the Windows® programming tools may change, but the customer will not have to modify the application code. The hardware, software tool and application software can be compared to the sides of a triangle. If hardware and/or software changes, the angles must adjust for the application software to remain unchanged. We expanded the abbreviation COS to the name COSinus due to the trigonometric relationships in triangles.

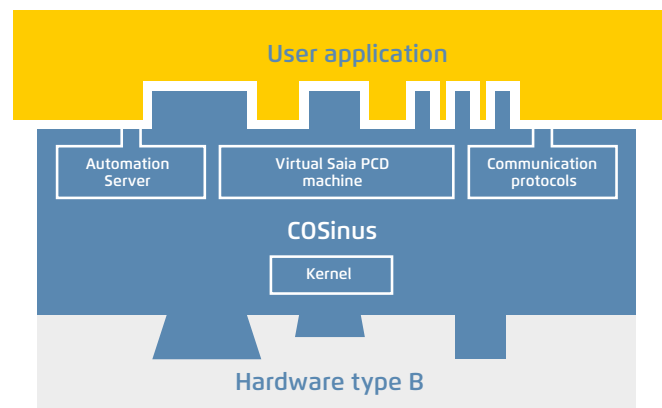
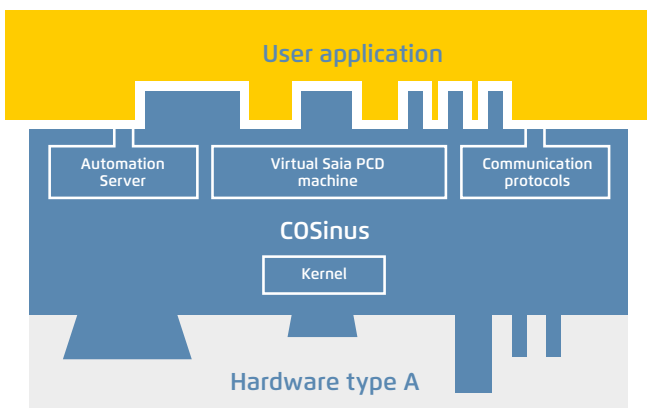

▲ The COSinus operating system always provides the application with the same infrastructure, regardless of the underlying hardware and processor. The key to this is the Saia virtual machine. It ensures that an application program created with PG5 works on all PCDs across generations.

Execution of the user program

The user program consists of one or more organisation blocks that are executed by the PCD Interpreter. Each user program has at least one cyclical organisation block, COB, the COB0.

The PCDs are mono-processor systems. Saia PCD 1, 2, 3 control and regulation devices have a main processor that processes all the tasks. The user program has a special role here and is processed as a core task. In addition to the user program, any communication tasks and server functions (web, FTP) are processed. The CPU capacity is allocated accordingly. The cycle time for the user program not only depends on the length of the program itself, but also on the simultaneous additional load.

Examples:

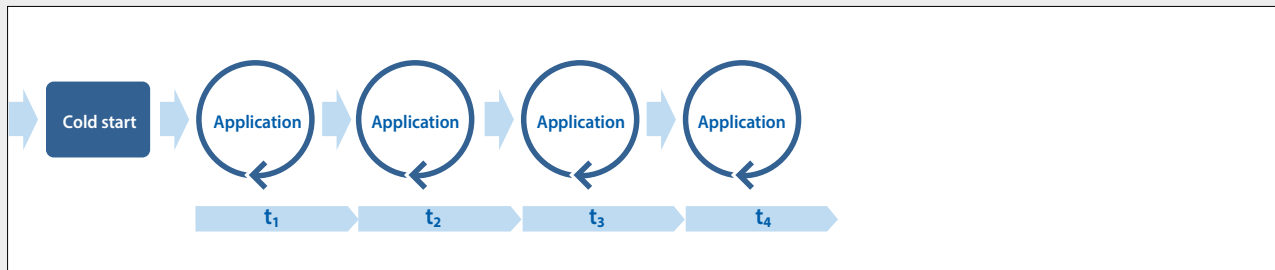

▲ Cycle time with no additional communication

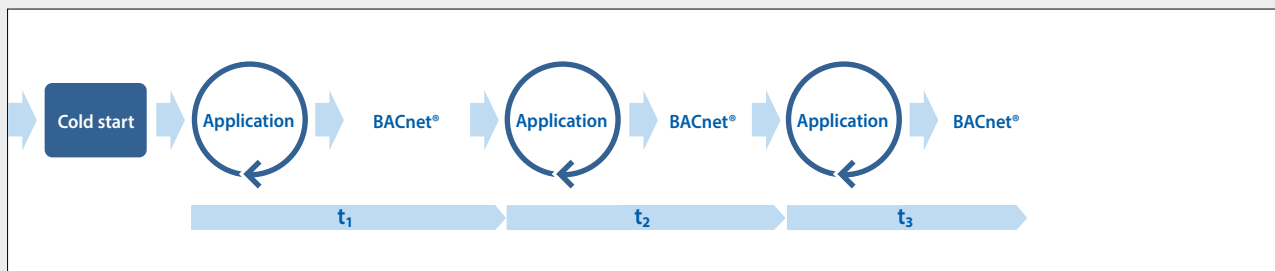

▲ Cycle time with BACnet® communication

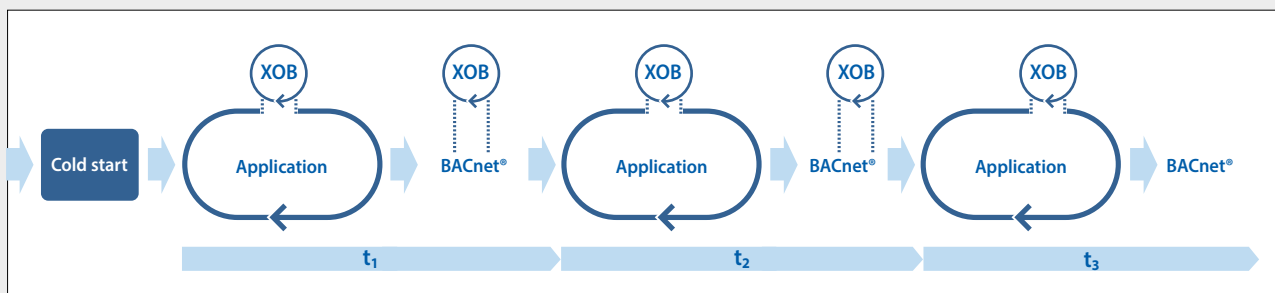

▲ Cycle time with BACnet® communication and interrupt (XOB)

The more communication takes place, the longer the cycle time (t_n), which may result in variations in the cycle time. If this variation in the cycle time is not required, for example because regulation must take place in a fixed time period and ideally without jitters, make sure that this part of the program is executed in an XOB. The priority of the XOBs is higher than that of the COBs and higher than many other operating system tasks. The above example shows that a periodic XOB interrupts the cyclic program and the execution of the BACnet® task.

! The COSinus operating system ensures that all tasks are processed. An intelligent load balance must be maintained between the user program and communication. This actually occurs in planning practice. It is only problematic if the contractor uses a lower performing Saia PCD CPU than planned to save money or is "saving" on CPUs by concentrating tasks on one CPU.

The main XOBs and their priority levels

Priority 4

- ▶ XOB 0: Network out

Priority 3

- ▶ XOB 7: System overload – displayed if the interrupt XOB queue is overflowing
- ▶ XOB 13: Error flag – displayed in the event of communication or calculation errors or an invalid instruction

Priority 2

- ▶ XOB 16: Cold start
- ▶ XOBs 14, 15: Periodic XOBs
- ▶ XOBs 20...25: Interrupts

Priority 1

- ▶ XOB 2: Battery failure
- ▶ XOB 10: Nesting depth exceeded when PB/FBs are displayed
- ▶ XOB 12: Index register overflow

Data types and program blocks*

Register (32 bit) 16,384
 Flags (1 bit): 16,384

Timers (31 bit) and meters (31 bit): 1600
 (Partitioning configurable)

Cyclical organisation blocks COB: 0...31
 "Exception" organisation blocks (XOB): 0...31

Program blocks (PB): 1000
 Function blocks (FB): 2000
 Text/data blocks DB: 8192
 Sequential blocks (SB): 96

You can find a full list in the PG5 help section.

* This information is dependent on the hardware and the COSinus version.

Saia PCD® Opcode

Saia PG5® generates a platform-independent opcode that is interpreted by the Saia PCD. As a result, the same program runs on different platforms. This also enables the user program to be updated with a flash card as the operating system of the Saia PCD performs the necessary actions to copy and execute the program from the flash card to the memory.

Code that is generated (= compiled) and optimised for the specific platform will of course run faster. This compiler is not integrated into the PC tool (Saia PG5®). Saia PCD COSinus knows how this code should be implemented into the relevant hardware most effectively. The program is compiled when it is loaded into the Saia PCD.

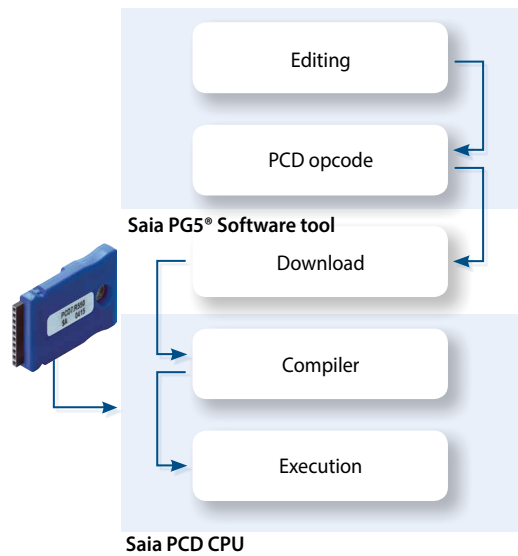

Automation server

The Automation Server is part of the COSinus operating system. It includes widespread web/IT technologies and ensures data exchange between users and automation solutions with no proprietary hardware or software required.

Specifically adjusted automation functions and objects form the relevant counterpart in the controller application. The web/IT functions can therefore be optimally and seamlessly integrated into the automation device and used efficiently.

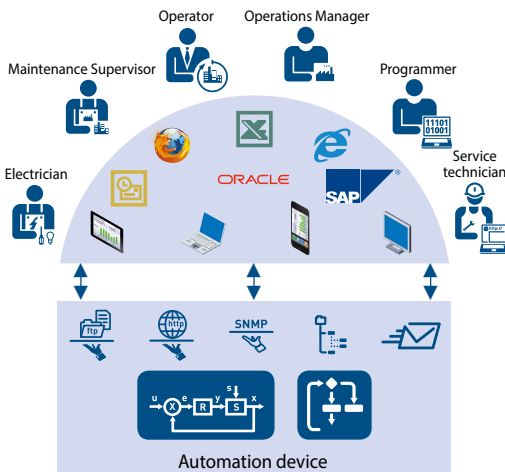

▲ Target group-oriented data output

Automation Server components



Web server:

The system and process are visualised in the form of web pages and can be requested from the web server via browsers such as Internet Explorer, Firefox, etc.



File system:

Process data, records, etc. are stored in easy-to-access files. Standard formats make it easy to process them further, e.g. with Microsoft Excel



FTP server

Load files into the automation device over the network using FTP, or export files from it.



Email:

Critical system statuses, alarms and log data can be sent by email.



SNMP:

Messages and alarms are transmitted in accordance with IT standards. Access to automation data using the IT management system.

... SNTP, DHCP, DNS ...

Memory management in the Saia PCD® systems

A user program may contain various data types. This includes data that is relevant for a fast regulation process and data records that must be collected over a long period or saved permanently. All these data types have different requirements in terms of hardware. For example, a regulation-relevant process requires a fast memory to calculate and provide current values. However, historical data records require sufficient remanent mass memory to cover a long period of time.

If a user program function is placed in PG5, various memory areas are required in the system. These areas can basically be divided into 3 groups. The parameter group controls the behaviour of the FBox that is processed in the user program. Defined statuses of the parameters result in responses in the FBox. Using the example of the HDLog function, the log data of the associated parameters is written to the file system in an Excel-compatible file format. Various templates are provided in the Web Editor to visualise this file in the web application.

These can be easily connected to the FBox using a range of parameters. As the visualisa-

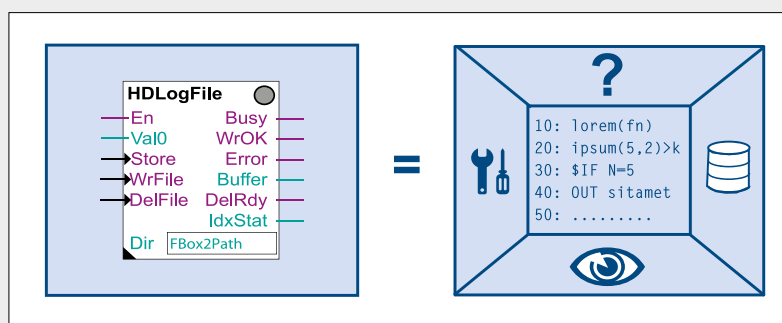

▲ Saia PG5® FBox shown as an object in the Saia PG5® Fupla engineering environment. To the right you can see which functions belong to the object.

tion pages only change when the Saia PG5® project is created, these are stored in the file system.

Memory areas of the Saia PCD® systems

A distinction is made between two key memory areas.

The user memory, which ensures fast access for reading and writing, contains time-critical content such as media and the program code executed by the CPU. However, this memory is not a programmable read-only memory (PROM) and is buffered by a battery.

The flash memory, on the other hand, permanently saves data and provides space for historical data records or data that will not change during the operation of the system. The backup of the user application can be stored in a file system, which means that the processing of the program is guaranteed.

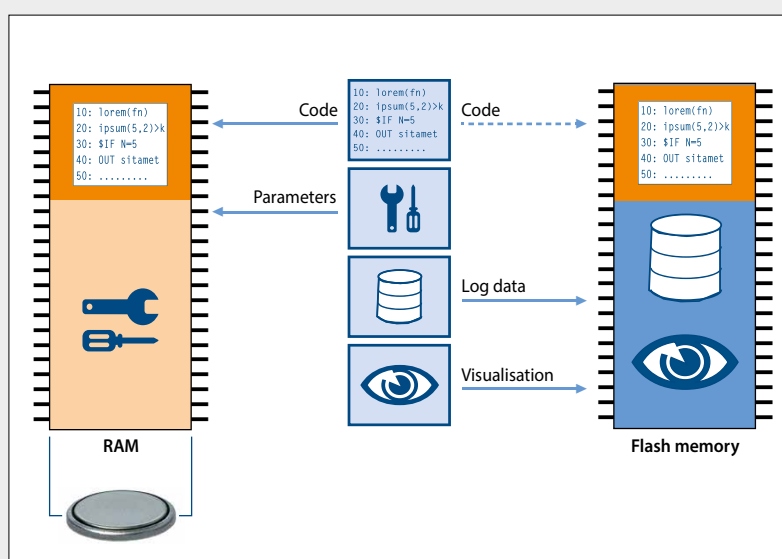

▲ This is how the functions of a memory area belonging to the Saia PG5® FBox are mapped.

Memory management of the Saia PCD® systems with COSinus operating system

Automation devices with integrated µSD card

The automation devices Saia PCD3 Plus, Saia PCD1.M2 and the programmable panel are provided with an onboard µSD flash card. When loading a user application with Saia PG5®, all the necessary files in the internal flash memory are stored on the µSD card. If the operating voltage is connected to the automation device and there is no executable program in the user memory, COSinus attempts to load a valid program from the µSD card on startup.



Automation devices with no integrated onboard flash

In the case of automation devices with no integrated µSD card and which are equipped with the COSinus system, the user application is copied direct to the user memory from Saia PG5®. If no valid program is detected in the user program when the controller is started up, a search is executed for a backup program in the onboard flash or an optional memory module.

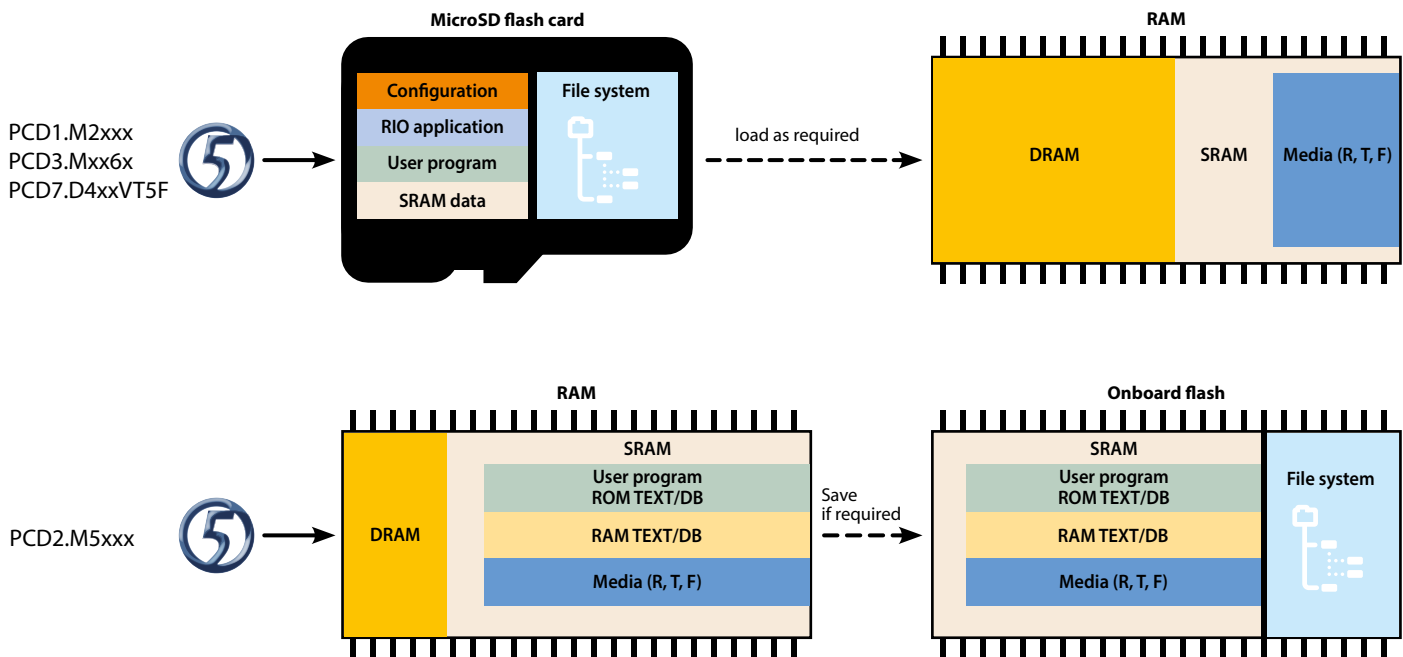

▲ Loading of the user program from Saia PG5® onto Saia PCD automation devices and allocation of different data between the storage media.

Memory expansion and resources of the Saia PCD® systems

Memory allocation of PCD1.M2xx0

RAM

- ▶ User program: 512 kByte ... 1 MByte
- ▶ DB/text: 128 kByte ... 1 MByte

Flash memory

- ▶ File system 8 ... 128 Mbytes (maximum of 900 ... 2,500 files or 225 ... 625 directories)

Flash memory expansions

- ▶ 1 expansion module

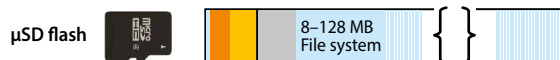

Memory allocation of PCD3.Mxx6x

RAM

- ▶ User program: 2 Mbyte
- ▶ DB/text: 1 Mbyte

Flash memory

- ▶ File system 128 Mbytes (maximum of 2,500 files or 625 directories)

Flash memory expansions

- ▶ 4 expansion modules



Memory allocation of PCD2.M5xx0

RAM

- ▶ User program and DB/text 1024 kbytes

Flash memory

- ▶ Backup memory 1024 kbytes

Flash memory expansions

- ▶ 4 expansion modules

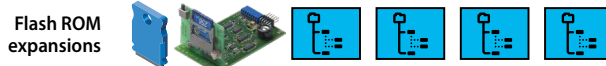

The system backup – entire automation project



The application's system backup contains all the vital information and data that must be available to process the application. This enables users to easily and securely reset the controller to a saved and known state.

With the system backup function of the Saia PCD COSinus operating system, it is also possible to fully duplicate a system and copy it to an identical piece of hardware with no additional adjustments required (copy/paste).

The system backup can be created in the office on a Saia PCD memory module using an automation device of identical construction. Any technician (without training, a manual or software tools) can then perform a system restore or a system update direct on site should any changes be applied – totally within the meaning of lean automation.



Creating a system backup

A system backup can also be created by the licence-free Saia PG5® software tool "Online Configurator".

The system can be backed up either on the internal flash memory module or on an optional memory module Saia PCD7.Rxxx.



Using a system backup

No dedicated software tools are required to restore a system backup. This only requires an optional Saia PCD7.Rxxx memory module that contains a system backup for the target controller.

Press and hold the run/stop button for 3 seconds to restore the application contained in the backup memory module. The COSinus operating system automatically looks for a system backup of the application in all the storage media connected to the automation device.

If a valid system backup of the operating system is found, it is "automatically" loaded into the user memory. The automation device restarts.



▲ Memory media for external backups

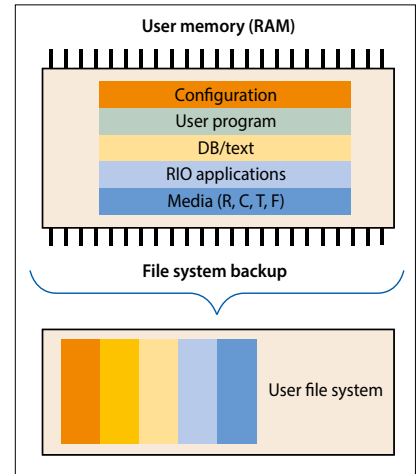

▲ Content of a system backup created on an external module with a file system

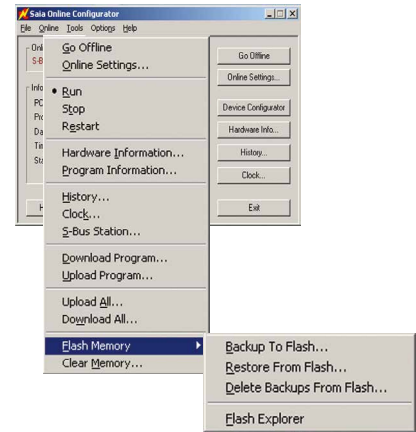

▲ Creation of a system backup with the Online Configurator

Expansion options of the user file system

Saia PCD systems can be expanded by at least 1 to a maximum of 4 external memory modules that contain a user system. An external file system is ideal as a backup for the entire user application and enables users to save trend data, alarms and event lists, as well as log files defined by the user. An external file system may contain up to 900 files or 225 directories.

PCD3.R600

Module holder for SD flash memory cards with 512 and 1024 MB



PCD7.R-SD512 / PCD7.R-SD1024

SD flash memory cards with 512 MB / 1024 MB

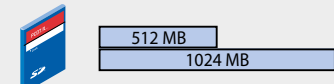

PCD7.R610 with PCD7.R-MSD1024

Basic module with Micro SD flash card with 1024 MB

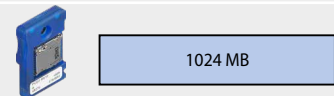

PCD7.R562 BACnet®

128 MB for file system and firmware expansion for BACnet® configuration files with BACnet® applications



Can third-party local I/Os be connected via S-Bus?

In the manual we have excluded these for the Saia PCD controllers. SBC S-Bus is a proprietary protocol that is essentially designed for communication with engineering and debugging tools, to connect the management level or process control systems and for PCD to PCD communication. It is not suitable or approved for the connection of local I/Os from different manufacturers. I/Os from third-party manufacturers should be integrated professionally and safely using one of the many manufacturer-independent field bus systems.

Can the Saia PCD controllers connect direct to the Internet?

When Saia PCD controllers are connected direct to the Internet, they are also a potential target of cyber attacks. Appropriate protective measures must always be taken to guarantee secure operation. PCD controllers include simple, integrated protection features. However, secure operation on the Internet is only ensured if external routers are used with a firewall and encrypted VPN connections. For more information, please refer to our support site: <http://sbc.do/Me4r-LqwE>

How do I connect a third-party device to the PCD if the protocol is not supported in the PCD firmware and there is not a corresponding FBox library either?

One of the greatest strengths of the Saia PCD is that, in addition to the numerous "off the shelf" communication protocols available, users themselves can implement any protocol required in the user program. This is possible via a serial interface and also via Ethernet. You can find PG5 example programs on our support site on this topic.

What is the difference between centralised and decentralised I/Os?

When remote I/Os are accessed, a communications task always has to run. This task interrupts the processing of the actual ICA task, thus extending the cycle time (page 11). If cycle time is important and critical, it is more efficient to use central I/Os.

How many central I/Os per Saia PCD®?

The I/O capacity of a Saia PCD automation station depends on the maximum number of pluggable I/O modules, i.e. 64 modules for the Saia PCD2 and Saia PCD3 series. Each module requires 16 bits. This gives a maximum of 1024 binary signals overall. Each Saia PCD CPU in this system catalogue can read all 1024 binary signals in under 10 msec and make them available to the user program logic. For calculation purposes, assume a value of 0.01 msec per binary I/O and 0.03 msec per analogue value.

In practice, the number of I/Os is limited by the cycle time required for the user program (see explanation page 11). If the Saia PG5® IL Editor is used to write a resource-efficient user program in text form, the 64 I/O slots of the Saia PCD automation station will be fully usable. The cycle time will certainly be well below 100 msec.

If the graphic software engineering tool Saia PG5® Fupla and prefabricated system templates (Saia PG5® DDC Suite) are used to create the application software, then only half the 64 possible I/O modules should be equipped for a cycle time of <100 msec. Additional communication and data processing tasks will further increase cycle time.

In the case of fully graphic software engineering for control-intensive applications combined with additional tasks (e.g., BACnet®, gateway, management functions), it is inadvisable to use more than 300 I/Os per automation station.

How does communication influence the application cycle time?

If the PCD is set as the server (master station), it has little or no control over its partner stations. Should these partner stations send large amounts of data simultaneously, the PCD MUST receive them. The receiving/processing of these data packages will take priority over the application cycle time. The cycle time may consequently be increased depending on the workload. The PCD processing time may be significantly increased if several partner stations send large volumes of data simultaneously.

The impact will be minimal if the PCD is set as client (slave station).

The figures below are based on a PCD3.M5340 with a program cycle time of 100 ms, excluding additional communication.

Web server Displaying a page on a micro browser panel or PC does not have a major impact. Loading a large file such as a Java applet or an offline trend during the transfer can increase cycle time by 40...50%. The same applies when large files are transferred via FTP.

S-Bus or Modbus communication via Ethernet: Each partner station running under full load increases the cycle time by approx. 8%.

Serial S-Bus: Each slave-type communication at 38.4 kbit/s increases the cycle time by 5% (port #2). In the case of PCDx.F2xx modules, the increase is approx. 17%.

At 115 Kbits the cycle time is approximately 20% higher. **Modbus RTU:** A client at 115 kbit/s increases the cycle time by about 11% (port #2). In the case of PCDx.F2xx modules, the increase is approx. 45%.

What exactly does MTBF mean? Where can I find the MTBF values for Saia PCD® controllers?

MTBF stands for Mean Time Between Failures. The time referred to is the period of operation between two consecutive failures of a unit (module, device or system). The higher the MTBF value, the more "reliable" the device. On average, a device with a MTBF of 100 hours will fail more often than a similar device with a MTBF of 1,000 hours. The MTBF value can be calculated in purely mathematical terms or based on empirical values.

Please bear in mind that the MTBF value of the overall installation depends on the values of the individual switch cabinet components.

An overview of the MTBF values of the PCD controllers is included on our [support site](#).

The return rate is of greater relevance in practice. We analyse all the devices that return from the field. The return rates of the current PCD controllers during the warranty period (30 months) are as follows:

- ▶ PCD2.M5xxx: 0.94%
- ▶ PCD3.M5xxx: 0.99%
- ▶ PCD3.M3xxx: 1.14%

What part of the memory will be lost if the battery fails, and how does the PDC react?

In theory, the user memory of the PCD, which contains the content of the media such as registers, counters, meters, flags, and the writeable part of the DB and text elements, will be lost in the event of a failure of the power supply with a battery that is also weak or defective. We now have to distinguish between two different types of PCDs.

Controllers equipped with an internal micro SD card store the user program and associated initial values of the media in a system partition. Should the user memory be lost with no backup, the data will be reloaded into the user memory and the program will be processed again with the parameters that were defined at the time of the download in PG5.

Controllers with no internal file system require a backup containing the user program and associated media. This backup can be created using PG5 when downloading the application. As a general rule, there should be a backup of the PCD of the last download of an application to an external file system of the PCD to restore the program and media content in the event of an empty memory.

If a backup of the application of a PCD is available and the content of the user memory is not feasible, the application will be restored from the point at which the backup was created.

1.2 PCD3 – modular cartridge construction

1.2.1 Overview of fully programmable controllers Saia PCD3 device series

Design of the Saia PCD3 series

Page 20

Description of the basic structure and general features of the modular Saia PCD3 series

Saia PCD3.Mxxxx controllers

Base units with 4 slots for I/O modules

- ▶ PCD3.Mxx60 High Power CPU
- ▶ PCD3.M3x60 Minimum Basic CPU

Up to 5 integrated communication interfaces that can be expanded by up to 13 communication interfaces using plug-in modules. Integrated Automation Server in all CPUs.



22

Saia PCD3.Txxx remote I/O stations RIOs

Remote peripheral nodes

- ▶ PCD3.T66x Smart Ethernet RIO



34

Saia PCD3.Cxxx module holder for I/O expansion

Module holder for I/O modules

- ▶ PCD3.C100 4 I/O slots
- ▶ PCD3.C110 2 I/O slots
- ▶ PCD3.C200 4 I/O slots with 24 VDC power supply

Expandable up to 1023 I/Os



21

Saia PCD3 input/output modules in cassette design

Modules with various functions with plug-in terminals

- ▶ PCD3.Axxx Digital output modules
- ▶ PCD3.Bxxx Combined digital input/output modules
- ▶ PCD3.Exxx Digital input modules
- ▶ PCD3.Wxxx Analogue input/output modules



26

Saia PCD3 interface modules

Plug-in modules to expand the communication interfaces
(up to 4 modules or 8 interfaces)

- ▶ PCD3.F1xx 1 serial interface RS-232, RS-422/485
- ▶ PCD3.F2xx 2 serial interfaces RS-232, RS-422/RS-485 BACnet® MSTP, DALI, M-Bus, Belimo MP-Bus

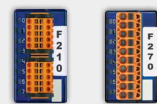

30

Saia PCD3 memory modules

Plug-in memory modules for data and program backup

- ▶ PCD3.R5xx Flash memory module for slots 0...3
- ▶ PCD3.R6xx Basic module for SD flash card for slots 0...3
- ▶ PCD7.R-SD SD Flash cards for PCD3.R6xx
- ▶ PCD7.R5xx Flash memory module for slots M1 and M2
- ▶ PCD7.R610 Basic module for micro SD flash card
- ▶ PCD7.R-MSD Micro SD flash cards for PCD7.R610



31

Consumables and accessories for Saia PCD3 controllers

Batteries, terminals, system cables, labelling accessories...



33

Design of Saia PCD3 controllers

The CPU has been incorporated into the back panel of the device, unlike comparable systems. Its capacity can be increased individually with plug-in communication modules and/or intelligent I/O modules. These have a direct, very fast bus connection to the CPU.



PCD3.Mxxxx base unit

Base unit with CPU and 4 slots for I/O modules, communication or other specific modules (e.g. PCD3.Hxxx counter modules)

Device design

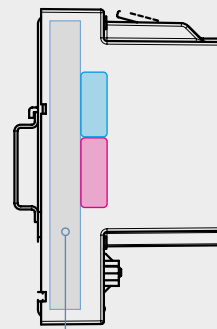
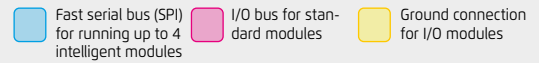
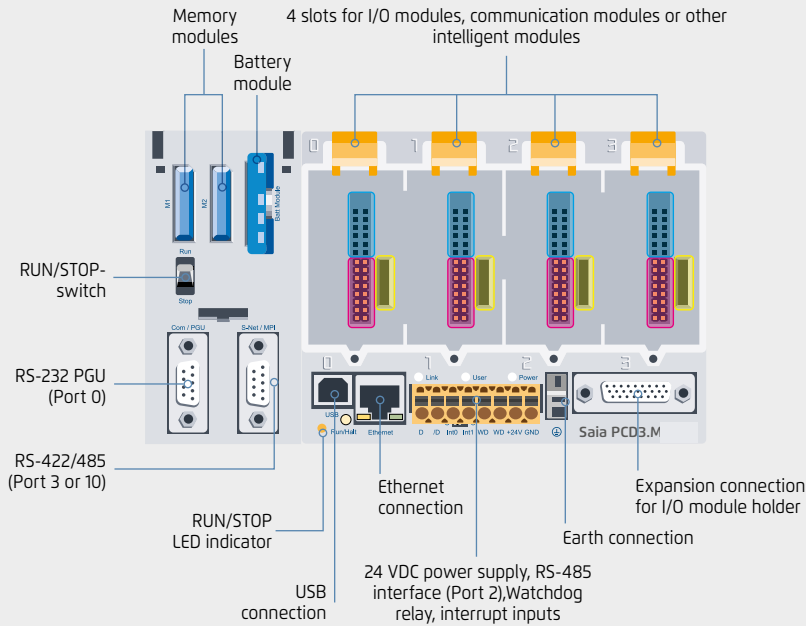

The CPU is incorporated into the back panel. An additional 4 I/O modules can therefore be inserted into the same area.

With the left expansion, the Standard (PCD3.M5/M6xxx) and High Power (PCD3.Mxx60) CPU types have slots for a battery holder module with LED indicators, a run/stop switch, two slots for flash memory modules and two additional communication interfaces. The LED indicators on the battery module display the status of the CPU and battery and any errors in the application. The battery also protects the data in the event of an interruption to the power supply. It can be replaced during operation while under power. The configuration, programs and data can be transferred from one controller to another using the plug-in flash memory modules. No programming tool is required for this.

Dimensions

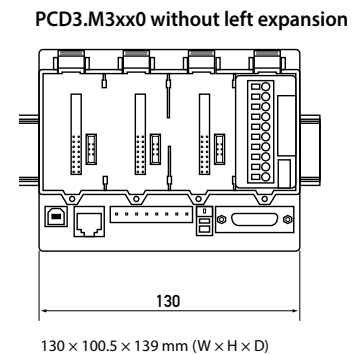
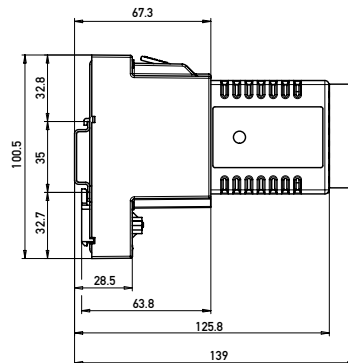
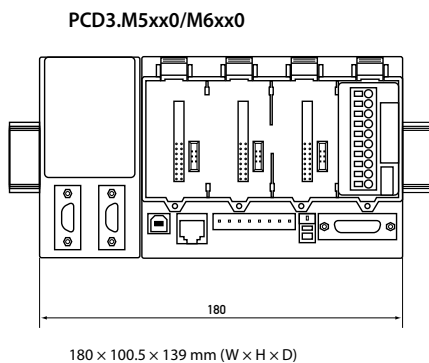

▲ Standard and High Power CPU with slots for battery and memory modules, run/stop switch and additional interfaces

▲ Minimum Basic CPU without battery module. PCD3.Rxxx memory modules are plugged into an I/O slot.

Saia PCD3.Cxxx module holder

I/O expansion module holders are available in either a 2- or 4-slot version. This enables users to expand the PCD3 controllers to a max. 64 I/O modules or a max. 1023 I/Os.

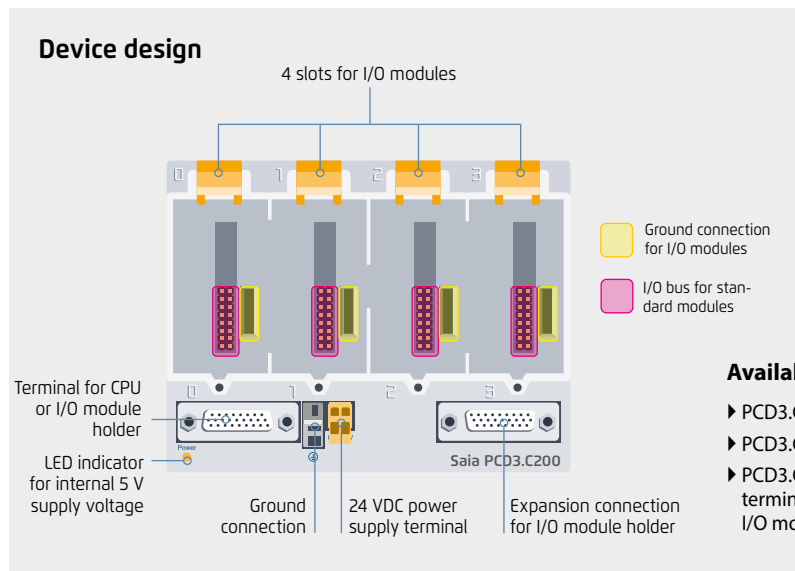

All standard I/O modules can be used in the expansion module holders. Communication modules or other intelligent modules can only be used in the slots of the Basic CPU.

Available types

- ▶ PCD3.C100 Expansion module holder with 4 I/O slots
- ▶ PCD3.C110 Expansion module holder with 2 I/O slots
- ▶ PCD3.C200 Expansion module holder with 4 I/O slots and terminal connectors for 24 VDC power supply for all connected I/O modules, plus any downstream PCD3.C1xx module holders

PCD3.C100/200 with 4 I/O slots

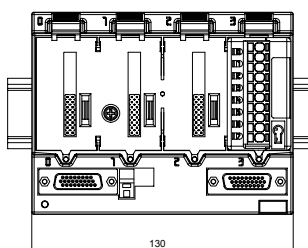

PCD3.C110 with 2 I/O slots

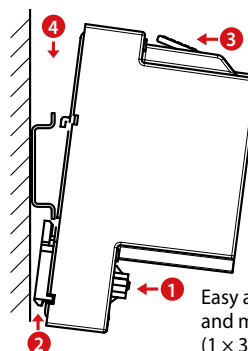
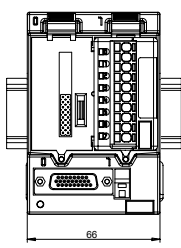

Easy assembly of the CPUs and module holders on DIN rail (1 x 35 mm)

System expansion up to 1023 I/O

Single- and multiple-row mounting of the module holders

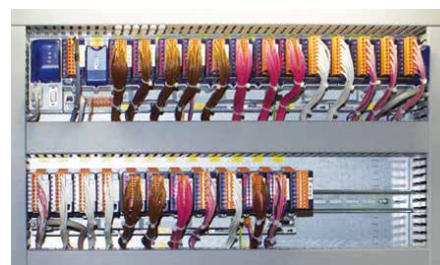
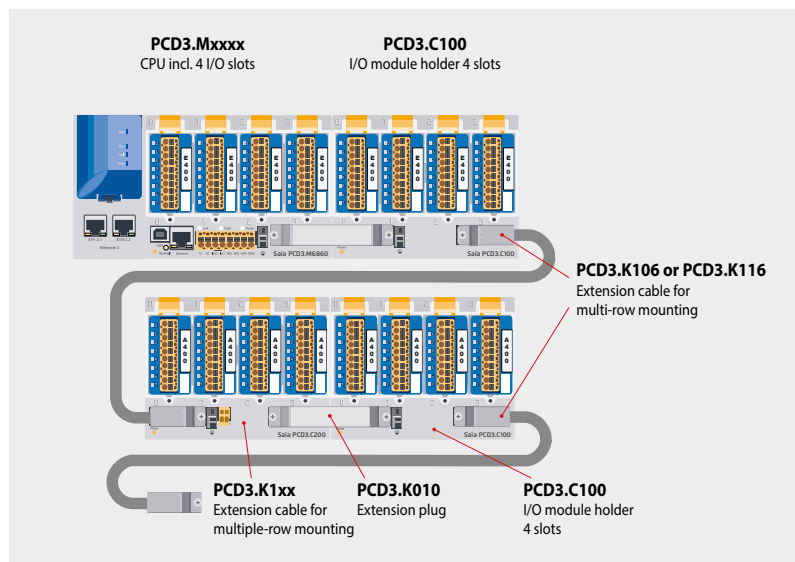

PCD3 in multiple-row mounting in the switch cabinet

Extension plug and cables

- ▶ PCD3.K010 Extension plug
- ▶ PCD3.K106 Extension cable 0.7 m
- ▶ PCD3.K116 Extension cable 1.2 m

Saia PCD3.Mxx60 controllers

High-performance CPU for any requirement

The fast processor and increased system resources provide the High Power CPU with sufficient power reserves to process the most demanding control and communication tasks.



System properties

- ▶ Up to 1023 inputs/outputs
Can be expanded remotely with RIO PCD3.T66x
- ▶ Up to 13 communication interfaces
- ▶ Onboard USB and Ethernet interface
- ▶ 2 Ethernet interfaces (PCD3.M6860 only)
- ▶ Fast program processing (0.1 μ s for bit operations)
- ▶ Large onboard memory for programs (2 MB) and data (128 MB file system)
- ▶ Memory with SD flash cards can be expanded up to 4 GB
- ▶ Automation Server for integration in Web/IT systems



Types

- ▶ **PCD3.M5360** CPU basic module with Ethernet TCP/IP, 2 MB of program memory
- ▶ **PCD3.M5560** CPU basic module with Ethernet TCP/IP, 2 MB of program memory, Profibus-DP-Slave
- ▶ **PCD3.M6860** CPU basic module with 2 Ethernet TCP/IP, 2 MB of program memory

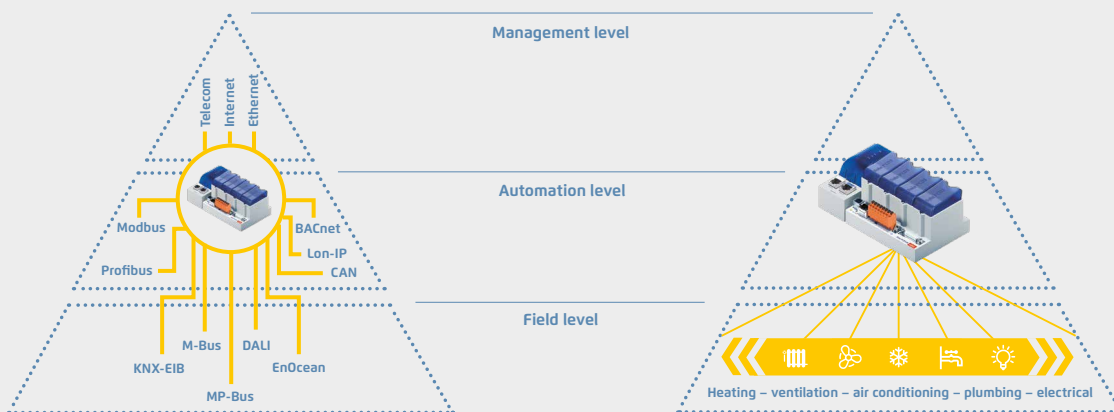

The Saia PCD3 Power CPU has sufficient system resources to operate up to 13 communication interfaces in the same device. Even the most demanding tasks, such as simultaneous communication via BACnet® and Lon IP, are handled reliably.

The generous memory resources (4 GB) of the new PCD3 Power CPU enable users to record/monitor, archive and control the data and statuses of all plants in the Saia PCD, even with no computer equipment and control system software. Applications for the various plants (HVAC) can be created easily using the graphic PG5 engineering tool and application-specific software libraries.

Saia PCD3.Mxx60 controllers

High-performance CPU

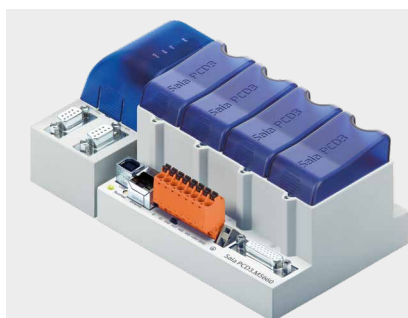

I/O	1023
File system	up to 4.2 GByte
Program	2 MByte
CPU Speed Basic Power	0.1/0.3 μ s bit/word

Technical Data	PCD3.M5360	PCD3.M5560	PCD3.M6860
	Power	Power DP Slave	Power 2 \times Ethernet
Number of inputs/outputs or I/O module slots	1023		
I/O expansion connection for PCD3.Cxxx module holder	Yes		
Processing time [μ s]	bit operation	0.1...0.8 μ s	
	word operation	0.3 μ s	
Real-time clock (RTC)	Yes		

Onboard memory

Program memory, DB/text (flash)	2 MB
User memory, DB/text (RAM)	1 MB
Flash memory (S-RIO, configuration and backup)	128 MB
User flash file system (INTFLASH)	128 MB
Data backup	1...3 years with lithium battery

Onboard interfaces

USB 1.1	Yes		
Ethernet 10/100 Mbps, full-duplex, auto-sensing/auto-crossing	Yes		2 \times
RS-232 on D-Sub connector (PGU/Port 0)	up to 115 kbits		No
RS-485 on terminal block (Port 2) or RS-485 Profibus-DP Slave, Profi S-Net on terminal block (Port 2)	up to 115 kbits up to 187.5 kbits	up to 115 kbits No	
RS-485 on D-Sub connector (Port 3)* or Profibus-DP Slave, Profi S-Net on D-Sub connector (Port 10)*	Up to 115 kbits ¹⁾ No	Up to 115 kbits ²⁾ Up to 1.5 Mbits ²⁾	No No

* can be used as an alternative

¹⁾ electrically connected

²⁾ electrically isolated

Options

The data memory can be expanded to 4 GB with flash memory modules (with file system).

Optional data interfaces

I/O slot 0	PCD3.F1xx modules for RS-232, RS-422, RS-485 and Belimo MP-Bus
I/O slot 0...3 up to 4 modules or 8 interfaces:	PCD3.F2xx modules for RS-232, RS-422, RS-485, BACnet [®] MS/TP, Belimo MP-Bus, DALI and M-Bus

General specifications

Supply voltage (in accordance with EN/IEC 61131-2)	24 VDC, -20/+25% max. incl. 5% ripple or 19 VAC \pm 15% two-way rectified (18 VDC)
Power consumption	typically 15 W for 64 I/Os
Capacity 5 V/+V (24 V) internal	max. 600 mA/100 mA

Saia PCD3.M3xx0 controllers

The base CPU for simple applications

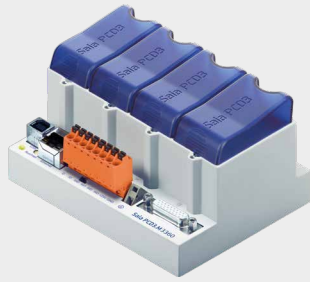

I/O	1023
File system	Up to 4 GB
Program	512 kByte
CPU Speed	0.3/0.9 μ s
CPU Speed Basic Power	0.1/0.3 μ s Bit/Word



Types

- ▶ PCD3.M3160 CPU basic module with Ethernet TCP/IP, 64 I/Os, 512 kByte of program memory
- ▶ PCD3.M3360 CPU basic module with Ethernet TCP/IP, 1023 I/Os, 512 kByte of program memory

Technical Data	PCD3.M3160	PCD3.M3360
	Basic Power	Basic Power
Number of inputs/outputs or I/O module slots	64	1023
I/O expansion connection for PCD3.Cxxx module holder	No	Yes
Processing times [μ s]	0.1...0.8 μ s 0.3 μ s	
Real-time clock (RTC)	Yes	

Onboard memory

Main memory (RAM) for program and DB/text	No
Program memory, DB/text (FLASH)	512 kByte
Working memory, DB/text (RAM)	128 kByte
Flash memory (S-RIO, configuration and backup)	128 MByte
User flash file system (INTFLASH)	128 MByte
Data backup	4 hours with SuperCap

Onboard interfaces

USB 1.1	Yes
Ethernet 10/100 Mbits, full-duplex, auto-sensing/auto-crossing	Yes
RS-485 on terminal block (Port 2) or RS-485 Profibus-DP Slave, Profi-S-Net on terminal block (Port 2)	up to 115 kbits up to 187.5 kbits

Options

The data memory can be expanded to 4 GB with flash memory modules (with file system).

Optional data interfaces

I/O slot 0	PCD3.F1xx modules for RS-232, RS-422, RS-485 and Belimo MP-Bus
I/O slot 0...3 - up to 4 modules or 8 interfaces:	PCD3.F2xx modules for RS-232, RS-422, RS-485, BACnet® MS/TP, Belimo MP-Bus, DALI and M-Bus

General specifications

Supply voltage (in accordance with EN/IEC 61131-2)	24 VDC, -20/+25% max. incl. 5% ripple or 19 VAC \pm 15% two-way rectified (18 VDC)
Power consumption	typically 15 W for 64 I/Os
Capacity 5 V/+V (24 V) internal	max. 600 mA/100 mA

Saia PCD3 input and output modules in cassette design

The functions of the Saia PCD3 can be expanded as required using a wide range of plug-in I/O modules and can be adapted to specific requirements. This not only ensures that a project can be implemented quickly, but also provides the option of expanding or modifying the system at any time.

System properties

- ▶ Numerous variants available
- ▶ Slot direct in the Saia PCD3 basic CPU or in the module holder
- ▶ Full integration in the Saia PCD3 housing
- ▶ Stable cartridge construction
- ▶ Connection to the I/O level via plug-in spring terminal blocks or ribbon cables and adapters
- ▶ I/O terminal blocks are supplied as standard
- ▶ No tools required for replacing modules

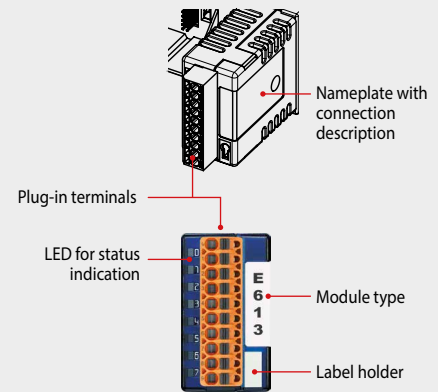

Insertion of I/O modules

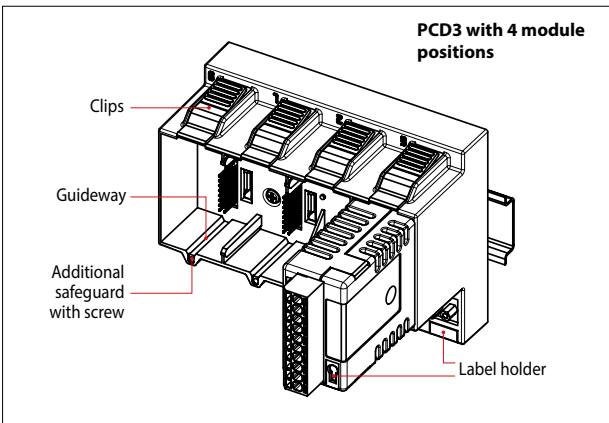

▲ Simple exchange of I/O modules

Over 50 modules available with different functionalities

Types

- ▶ PCD3.Axxx Digital output modules
- ▶ PCD3.Bxxx Combined digital input/output modules
- ▶ PCD3.Exxx Digital input modules
- ▶ PCD3.Fxxx Communication modules
- ▶ PCD3.Hxxx Fast counter modules
- ▶ PCD3.Rxxx Memory modules
- ▶ PCD3.Wxxx Analogue input/output modules

Connecting plugs/terminals

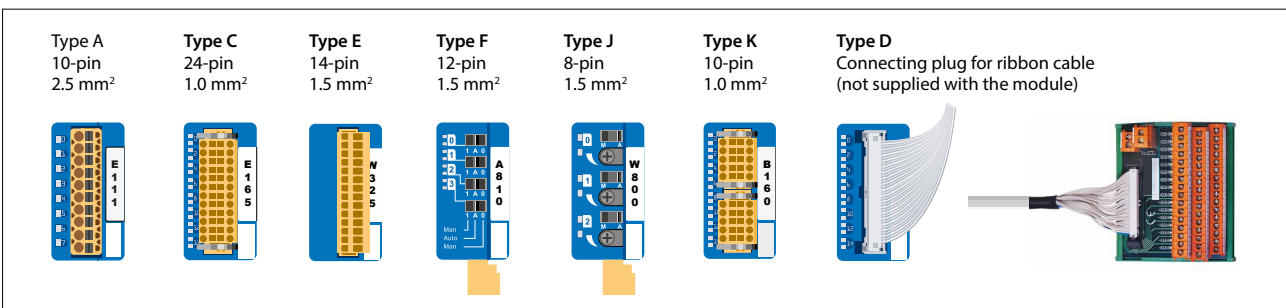

▲ Spare terminals, ribbon connectors with system cables and separate terminals are ordered as accessories (see pages 33 and 150).

Saia PCD3 digital input and output modules

The digital I/O modules can be easily plugged into the Saia PCD3 Basis CPU or an appropriate module holder. In addition to inputs for various voltage levels, digital outputs are provided with both transistor construction and as mechanical relays. This means that electrical isolation from the switching electrical circuit can be achieved easily and reliably.

Digital input modules

Type	Number of inputs	Input voltage	Output switching capacity		Input delay	Electrical isolation	Internal current draw		I/O connector type ³⁾
			DC	AC			5 V-Bus ¹⁾ + V-Bus ²⁾	V-Bus ²⁾	
PCD3.E110	8	15...30 VDC	---	---	8 ms	---	24 mA	---	A
PCD3.E111	8	15...30 VDC	---	---	0.2 ms	---	24 mA	---	A
PCD3.E160	16	15...30 VDC	---	---	8 ms	---	10 mA	---	D
PCD3.E161	16	15...30 VDC	---	---	0.2 ms	---	10 mA	---	D
PCD3.E165	16	15...30 VDC	---	---	8 ms	---	10 mA	---	C
PCD3.E166	16	15...30 VDC	---	---	0.2 ms	---	10 mA	---	C
PCD3.E610	8	15...30 VDC	---	---	10 ms	●	24 mA	---	A

Digital output modules

Type	Number of outputs	Input voltage	Output switching capacity		Input delay	Electrical isolation	Internal current draw		I/O connector type ³⁾
			DC	AC			5 V-Bus ¹⁾ + V-Bus ²⁾	V-Bus ²⁾	
PCD3.A200	4, relay (make)*	---	2 A/50 VDC	2 A/250 VAC	---	●	15 mA	---	A
PCD3.A210	4, relay (break)*	---	2 A/50 VDC	2 A/250 VAC	---	●	15 mA	---	A
PCD3.A220	6, relay (make)	---	2 A/50 VDC	2 A/250 VAC	---	●	20 mA	---	A
PCD3.A251	8, relay (6 changeover + 2 make)	---	2 A/50 VDC	2 A/48 VAC	---	●	25 mA	---	C
PCD3.A300	6, transistor	---	2 A/10...32 VDC	---	---	---	20 mA	---	A
PCD3.A400	8, transistor	---	0.5 A/5...32 VDC	---	---	---	25 mA	---	A
PCD3.A410	8, transistor	---	0.5 A/5...32 VDC	---	---	●	24 mA	---	A
PCD3.A460	16, transistor	---	0.5 A/10...32 VDC	---	---	---	10 mA	---	D
PCD3.A465	16, transistor	---	0.5 A/10...32 VDC	---	---	---	10 mA	---	C
PCD3.A810	4, relay	---	2 A/50 VDC	5 A/250 VAC	---	●	55 mA	---	F
Manual operation	(2 changeover + 2 make)	---	2 A/50 VDC	6 A/250 VAC	---	●	---	---	F

* with contact protection

Digital input/output modules

Type	Number of I/Os	Input voltage	Output switching capacity		Input delay	Electrical isolation	Internal current draw		I/O connector type ³⁾
			DC	AC			5 V-Bus ¹⁾ + V-Bus ²⁾	V-Bus ²⁾	
PCD3.B100	2 In + 2 Out + 4 selectable In or Out	I: 15...32 VDC	0.5 A/5...32 VDC	---	8 ms	---	25 mA	---	A
PCD3.B160	16 I/O (configurable)	I: 24 VDC	0.25 A/18...30 VDC	---	8 ms or 0.2 ms	---	120 mA	---	2x K

Fast counter modules

Type	Number of counters	Inputs per counter	Outputs per counter	Counting range	Selectable digital filter	Current draw 5 V-Bus ¹⁾ + V-Bus ²⁾		I/O connector type ³⁾
						5 V-Bus ¹⁾	V-Bus ²⁾	
PCD3.H112	2	2 Inp. + 1 configurable Inp.	1 CCO	0...16 777 215 (24 Bit)	10 kHz...150 kHz	50 mA	4 mA	K
PCD3.H114	4	2 Inp. + 1 configurable Inp.	1 CCO	0...16 777 215 (24 Bit)	10 kHz...150 kHz	50 mA	4 mA	2x K

Overview of the internal bus capacity of the module holders

Capacity	PCD3.Mxx60	PCD3.Txxx	PCD3.C200
¹⁾ Internal 5V	600 mA	600 mA	1500 mA
²⁾ Internal +V (24 V)	100 mA	100 mA	200 mA

The electrical requirement of the internal +5V and +V bus for the I/O modules is calculated in the PG5 2.0 Device Configurator.

³⁾ Plug-in terminal blocks are included with I/O modules.

Spare terminals, ribbon connectors with system cables and separate terminals are ordered as accessories (see pages 33 and 150).

Saia PCD3 analogue input and output modules

The numerous analogue modules allow complex control tasks or measurements to be performed. The resolution is between 8 and 16 bits, depending on the speed of the AD converter. The digitised values can be further processed direct in the project in the Saia PCD3. The large number of different modules means that suitable modules are available for almost any requirement.

Analogue input modules

Type	Total Channels	Signal ranges/description	Resolution	Electrical isolation	Internal current draw		I/O connector type ³⁾
					5 V-Bus ¹⁾ + V-Bus ²⁾		
PCD3.W200	8 In	0...+10 V	10 Bit	---	8 mA	5 mA	A
PCD3.W210	8 In	0...20 mA ⁴⁾	10 Bit		8 mA	5 mA	A
PCD3.W220	8 In	Pt1000: -50°C...400°C/Ni1000: -50°C...+200°C	10 Bit		8 mA	16 mA	A
PCD3.W300	8 In	0...+10 V	12 Bit	---	8 mA	5 mA	A
PCD3.W310	8 In	0...20 mA ⁴⁾	12 Bit		8 mA	5 mA	A
PCD3.W340	8 In	0...+10 V/0...20 mA ⁴⁾ Pt1000: -50°C...400°C/Ni1000: -50°C...+200°C	12 Bit		8 mA	20 mA	A
PCD3.W350	8 In	Pt1000: -50°C...+600°C/Ni1000: -50°C...+250°C	12 Bit	---	8 mA	30 mA	A
PCD3.W360	8 In	Pt1000: -50°C...+150°C	12 Bit		8 mA	20 mA	A
PCD3.W380	8 In	-10 V...+10 V, -20 mA...+20 mA, Pt/Ni1000, Ni1000 L&S, NTC10k/NTC20k (configuration using software)	13 Bit		25 mA	25 mA	2x K
PCD3.W305	7 In	0...+10 V	12 Bit	•	60 mA	0 mA	E
PCD3.W315	7 In	0...20 mA ⁴⁾	12 Bit	•	60 mA	0 mA	E
PCD3.W325	7 In	-10 V...+10 V	12 Bit	•	60 mA	0 mA	E
PCD3.W745	4 In	Temperature module for TC type J, K and 4-wire Pt/Ni 100/1000	16 Bit	•	200 mA	0 mA	⁶⁾

Analogue output modules

Type	Number of channels	Signal ranges/description	Resolution	Electrical isolation	Internal current draw		I/O connector type ³⁾
					5 V-Bus ¹⁾ + V-Bus ²⁾		
PCD3.W400	4 Out	0...+10 V	8 Bit	---	1 mA	30 mA	A
PCD3.W410	4 Out	0...+10 V/0...20 mA/4...20 mA jumper-selectable	8 Bit		1 mA	30 mA	A
PCD3.W600	4 Out	0...+10 V	12 Bit	---	4 mA	20 mA	A
PCD3.W610	4 Out	0...+10 V/-10 V...+10 V/0...20 mA/4...20 mA jumper-selectable	12 Bit		110 mA	0 mA	A
PCD3.W605	6 Out	0...+10 V	10 Bit	•	110 mA	0 mA	E
PCD3.W615	4 Out	0...20 mA/4...20 mA parameters can be set	10 Bit	•	55 mA	0 mA	E
PCD3.W625	6 Out	-10 V...+10 V	10 Bit	•	110 mA	0 mA	E
PCD3.W800	4 Out, 3 of which are manually operated	0...+10 V, short circuit-protected	10 Bit	---	55 mA	35 mA ⁵⁾	J

Analogue input/output modules

Type	Number of channels	Signal ranges/description	Resolution	Electrical isolation	Internal current draw		I/O connector type ³⁾
					5 V-Bus ¹⁾ + V-Bus ²⁾		
PCD3.W525	4 In + 2 Out	In: 0...10 V, 0(4)...20 mA, Pt1000, Pt500 or Ni1000 (selectable via DIP switch) Out: 0...10 V or 0(4)...20 mA (selectable via software)	In: 14 Bit Out: 12 Bit	•	40 mA	0 mA	I

Manual control modules

PCD3.A810
Relay outputs,
2 changeover and
2 make



PCD3.W800
4 analogue outputs
(3 of these operable)



Overview of the internal bus capacity of the module holders

Capacity	PCD3.Mxx60	PCD3.T66x	PCD3.C200
¹⁾ Internal 5V	600 mA	600 mA	1500 mA
²⁾ Internal +V (24 V)	100 mA	100 mA	200 mA

The electrical requirement of the internal +5V and +V bus for the I/O modules is calculated in the PG5 Device Configurator.

³⁾ Plug-in I/O terminal blocks are included with I/O modules. Spare terminals, ribbon connectors with system cables and separate terminals are ordered as accessories (see pages 33 and 150).

⁴⁾ 4...20 mA via user program

⁵⁾ At 100% output value and 3 kΩ load

⁶⁾ With soldered spring terminal block

Information for project planning with PCD3 module holders

The internal load current taken by the I/O modules from the +5V and +V (24V) supply must not exceed the maximum supply current specified for the CPUs, RIOs or PCD3.C200 module holders.

Example calculation for the current consumption of the internal +5V and +V (24V) bus of the I/O modules

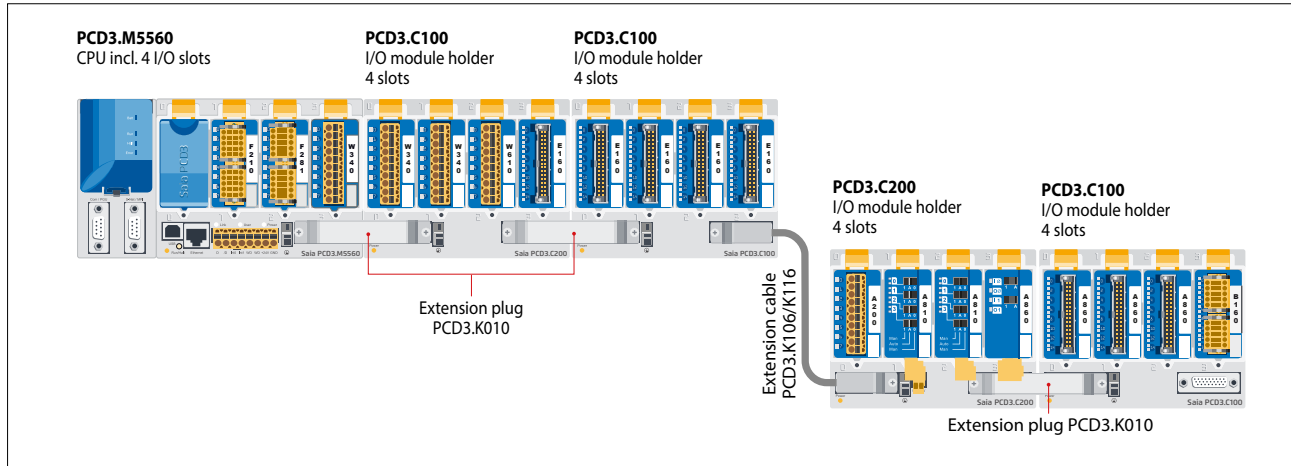

Consumption M5560 + C100 + C100

Module	Internal 5V	Internal +V (24V)
Not used		
F210	110 mA	
F281	90 mA	15 mA
W340	8 mA	20 mA
Total M5560	208 mA	35 mA
W340	8 mA	20 mA
W340	8 mA	20 mA
W610	110 mA	0 mA
E160	10 mA	
Total C100	136 mA	40 mA
E160	10 mA	
E160	10 mA	
E160	10 mA	
E160	10 mA	
Total C100	40 mA	0
Total M5560	384 mA	75 mA

Consumption C200 + C100

Module	Internal 5V	Internal +V (24V)
A200	15 mA	
A810	40 mA	
A810	40 mA	
A860	18 mA	
Total C200	113 mA	
A460	10 mA	
A460	10 mA	
A460	10 mA	
W380	25 mA	25 mA
Total C100	55 mA	25 mA
Total C200	168 mA	25 mA

Capacity	PCD3.M5560	PCD3.C200
Internal 5V	600 mA	1500 mA
Internal +V (24V)	100 mA	200 mA

The calculation example shows that internal capacity is maintained in the CPU basic module PCD3.M5560 and the holder module PCD3.C200. The CPU basic module has a sufficient reserve to receive an additional communication module in the empty slot 0. The holder module PCD3.C200 also has sufficient reserves to connect an additional PCD3.C100 or PCD3.C110 holder module. The power consumption of the internal +5V and +V (24V) bus for the I/O modules is automatically calculated in the PG5 2.x Device Configurator.



The following aspects should be considered when planning PCD3 applications:

- ▶ In keeping with lean automation, it is recommended to leave the first slot in the CPU basic module free for any subsequent expansions. Both single I/O modules and communication modules can be used in this slot.
 - ▶ The total length of the I/O bus is limited by technical factors; the shorter, the better.
 - ▶ Insert a PCD3.C200 after each cable (at the start of a row). Exception: In a small configuration with no more than 3 PCD3.C1xxs, these can be supplied from the PCD3.Mxxx. A PCD3.C200 is not required.
 - ▶ If an application is mounted in a single row (max. 15 module holders), then after five PCD3.C100 a PCD3.C200 must be used to amplify the bus signal (unless the configuration ends with the fifth PCD3.C100).
 - ▶ If the application is mounted in multiple rows, the restricted length of cable means that only three module holders (1× PCD3.C200 and 2× PCD3.C100) may be mounted in one row.
- The PCD3.C200 is used to extend the I/O bus or for the internal power supply (+5V and +V (24V)) to a module segment. Please note the following rules:**
- ▶ Do not use more than six PCD3.C200s in a single configuration, or the time delay will exceed the I/O access time.
 - ▶ Use a maximum of five PCD3.K106/116 cables.

Saia PCD3 power supply and connection concept

External power supply

A two-way rectified supply can be used for most modules. The following modules must be connected to smoothed 24 VDC: PCD3.H1xx

It is generally recommended to use robust and interference-resistant SBC power supply units with 24 VDC output. See Chapter 5.1 for available types.

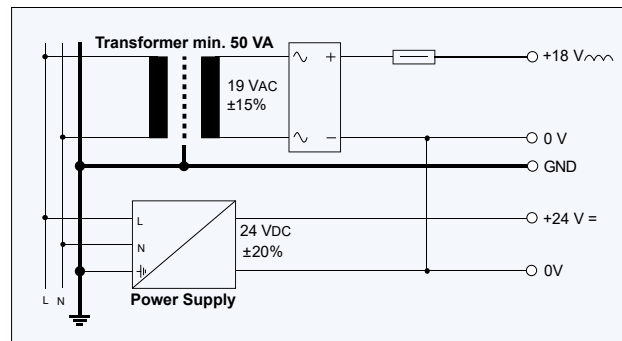

Grounding and connection plan

- ▶ The zero potential (GND) of the 24 V supply is connected to the GND and the controller's grounding terminal. If possible, this should be connected to the ground bar with a short wire (<25 cm) with a cross section of 1.5 mm². The same applies to the negative connection to the PCD3.F1xx or the interrupt terminal.
- ▶ Any shielding of analogue signals or communication cables should also be brought to the same grounding potential, either via a negative terminal or via the ground bar.
- ▶ All negative connections are linked internally. For flawless operation, these connections should be reinforced externally by short wires with a cross section of 1.5 mm².

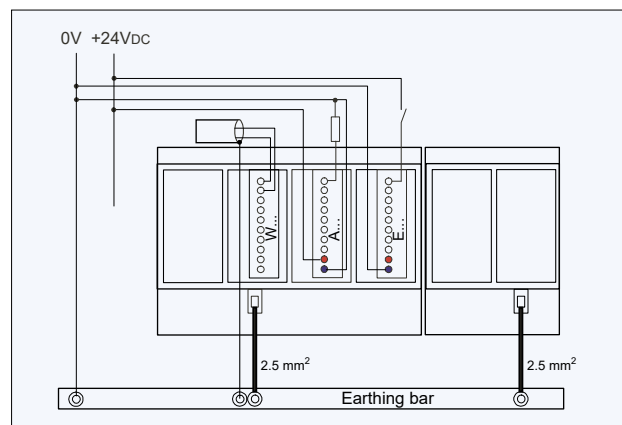

Grounding and connection concept analogue inputs that are not electrically isolated (PCD3.W2x0, PCD3.W3x0)

Signal sources (such as temperature sensors) should be connected direct to the input module wherever possible.

To obtain optimum measurement results, avoid connection to a ground bar. Additional external GND connections to the sensor signals may result in equalising currents which distort the measurement.

If shielded cables are used, the shielding should be continued to a ground bar.

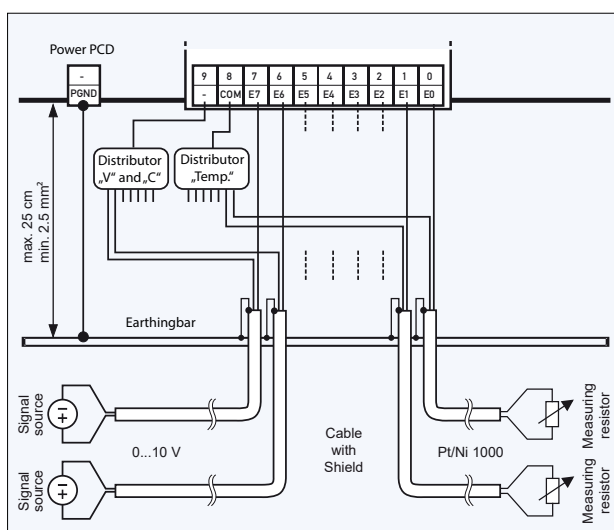

Connection concept for PCD3.W3x0

The reference potential of voltage and current inputs must be wired to a common GND distributor at the "-" terminal. Temperature sensors must be wired to a common GND distributor at the "COM" terminal. The module PCD3.W380 has a 2-wire connection for the inputs and requires no external GND distributor.

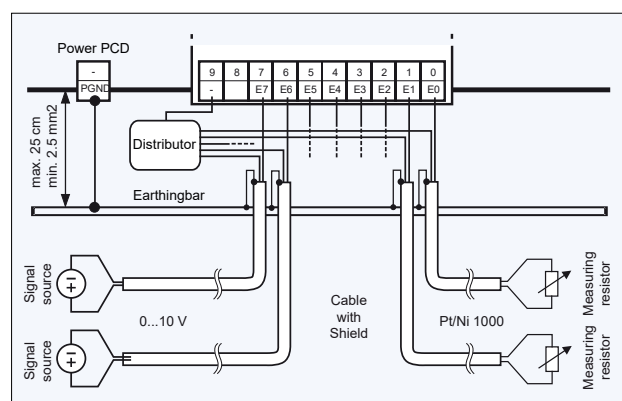

Connection concept for PCD3.W2x0

The reference potential of signal sources must be wired to a common GND distributor at the "-" terminal

Communication interfaces of Saia PCD3.Mxxxx controllers

In addition to the interfaces that the Saia PCD3 has onboard, the interface functions can also be expanded using various slots. Numerous protocols are therefore supported by the PCD3. For the majority of protocols, the physical bus specifications are offered as a plug-in module. If this is not the case, the bus can be connected via an external converter.

Protocols supported by PCD3.Mxxxx via FBoxes

- ▶ Modem communication with the PCD
- ▶ S-Bus
- ▶ Modbus
- ▶ JCI N2-Bus
- ▶ KNX® S-Mode/EIB (with external converter)
- ▶ DALI
- ▶ EnOcean (with external converter)
- ▶ M-Bus
- ▶ BACnet® MS/TP
- ▶ HMI editor applications with PCD7.Dxxx text terminals (RS-232 only)

ref.Modbus

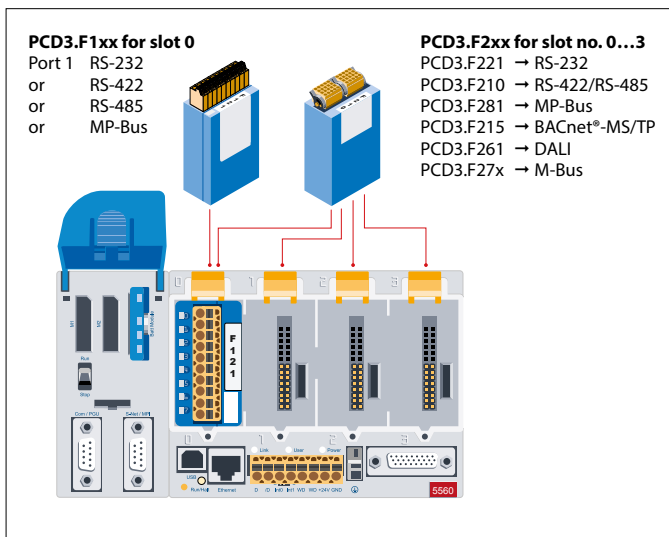
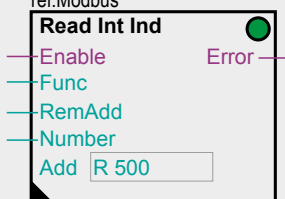

Fully programmable physical interfaces

Module	Specifications	Slot	Electrical isolation	Internal current draw 5V +V (24 V)		I/O connector type ¹⁾
PCD3.F110	RS-422 with RTS/CTS or RS-485 ²⁾	I/O 0	---	40 mA	---	A
PCD3.F121	RS-232 with RTS/CTS, DTR/DSR, DCD	I/O 0	---	15 mA	---	A
PCD3.F150	RS-485 ²⁾	I/O 0	•	130 mA	---	A
PCD3.F210	RS-422/RS-485 ²⁾ , plus PCD7.F1xxS as option	I/O 0...3	---	110 mA	---	2x K
PCD3.F221	RS-232 plus PCD7.F1xxS as option	I/O 0...3	---	90 mA	---	2x K

Physical interfaces for specific protocols

Module	Specifications	Slot	Electrical isolation	Internal current draw 5V +V (24 V)		I/O connector type ¹⁾
PCD3.F180	Belimo MP-Bus, for connecting up to 8 drives on one line	I/O 0	---	15 mA	15 mA	A
PCD3.F215	BACnet® MS/TP or freely programmable	I/O 0...3	---	110 mA	---	2x K
PCD3.F261	DALI	I/O 0...3	---	90 mA	---	A
PCD3.F270	M-Bus 240 nodes	I/O 0...3	---	70 mA	8 mA	A
PCD3.F271	M-Bus 20 nodes	I/O 0...3	---	70 mA	8 mA	A
PCD3.F272	M-Bus 60 nodes	I/O 0...3	---	70 mA	8 mA	A
PCD3.F281	Belimo MP-Bus with slot for PCD7.F1xxS modules	I/O 0...3	---	90 mA	15 mA	2x K

System properties required for PCD3.Fxxx modules:

The PCD3 system has a processor that serves both the application and the serial ports. To determine the maximum communication capacity for each PCD3.M5xx0 system, consult the information and examples provided in the manual 26-789 for PCD3.M5xx0.

Interface modules for optional insertion in PCD3.F2xx modules

Module	Specifications
PCD7.F110S	RS-422 with RTS/CTS or RS-485 ²⁾ (electrically connected)
PCD7.F121S	RS-232 with RTS/CTS, DTR/DSR, DCD, suitable for modem, EIB connection
PCD7.F150S	RS-485 ²⁾ (electrically isolated)d
PCD7.F180S	Belimo® MP-Bus for connecting up to 8 drives on one line

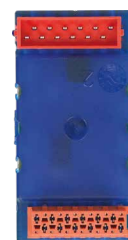

¹⁾ Plug-in I/O terminal blocks are included with I/O modules. Spare terminals, ribbon connectors with system cables and separate terminals are ordered as accessories (see pages 33 and 150).

²⁾ with termination resistors that can be activated.

Memory modules of Saia PCD3.Mxxxx controllers

In addition to the onboard memory contained in the base units, PCD3 controllers can also be expanded in a modular way with various flash memory modules for programs and data. The various communication protocols where the firmware is installed on the flash cards can also be used by simply inserting the relevant card.

More information on memory management and construction can be found in Chapter 1.1 Saia PCD System description.

System properties

- ▶ Configuration, programs and data can be transferred from one CPU to another
- ▶ Two slots (M1 and M2) for memory cards
- ▶ Additional memory cards can be inserted in the I/O slots using I/O adapters
- ▶ Memory can be expanded by up to 4 GB

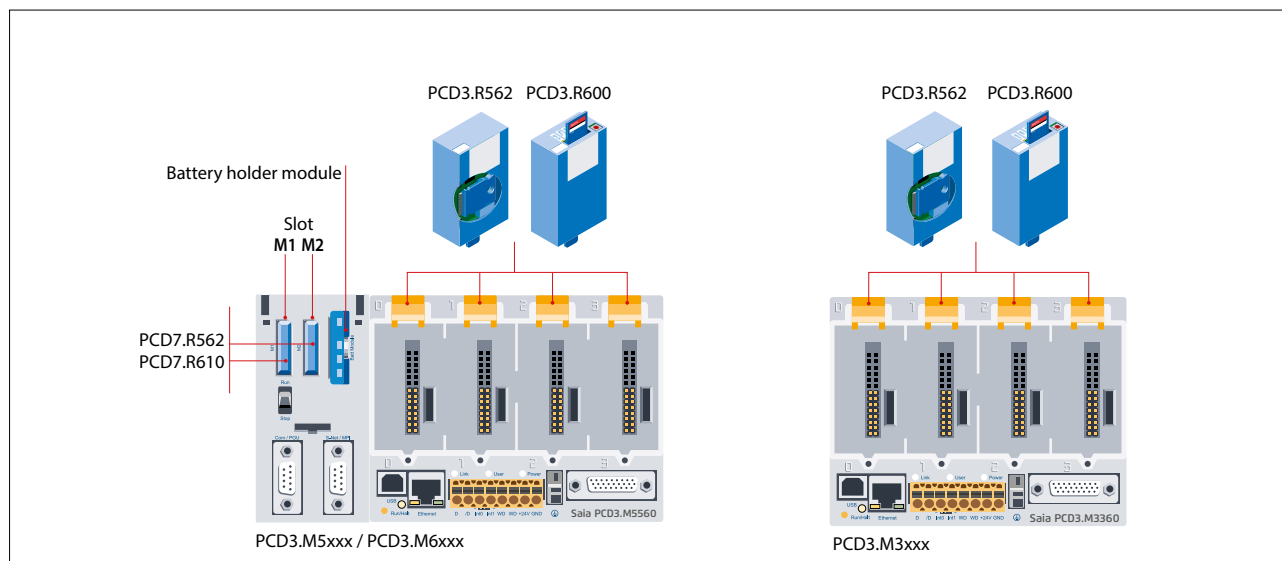

PCD7.R562



PCD7.R610

Flash memory with file system, program and data backup, BACnet® for M1/M2 slot

Type	Description	Slot
PCD7.R562	Flash card with BACnet® and 128 MB file system	M1 & M2
PCD7.R610	Basic module for Micro SD flash cards	M1 & M2
PCD7.R-MSD1024	Micro SD flash card 1024 MB, PCD formatted	PCD7.R610



PCD3.R56x

Plug-in flash modules for I/O module slots for all PCD3.Mxxxx0s

Type	Description	Slot
PCD3.R562	Flash card with BACnet® and 128 MB file system	I/O 0...3



PCD3.R600

Saia PCD3 basic module for SD flash cards with file system

Type	Description	Slot
PCD3.R600	Basic module with slot for SD flash cards (Up to 4 modules in I/O slots 0 to 3 on a CPU)	I/O 0...3
PCD7.R-SD512	SD flash card, 512 MB with file system	---
PCD7.R-SD1024	SD flash card, 1024 MB with file system	---

Spare parts (battery and battery holder module) see consumables and accessories (see pages 34 and 169).

Consumables and accessories for Saia PCD3 controllers

Labelling accessories



Addressing and labelling of I/O modules and module holders

I/O module slots in the module holder are labelled with numbers:

The provided inscription labels **1** can either be used for additional labelling of the I/O modules. They are blank and, depending on requirements, may either be labelled by hand.

The circuit diagram **2** printed on the side of each I/O module makes wiring easier and also helps during commissioning.

Sufficient space **3** is available on the other side of the cassette for the user to add customised labelling with the self-adhesive labels supplied.

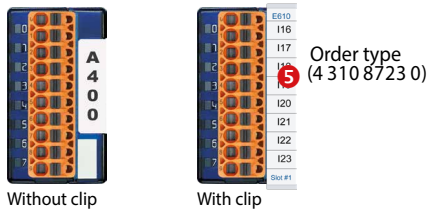

Additional labelling on the front **5**

The PCD3 modules can also be labelled on the front panel. Neutral labels with a snap-on cover (clip) are available for this purpose.

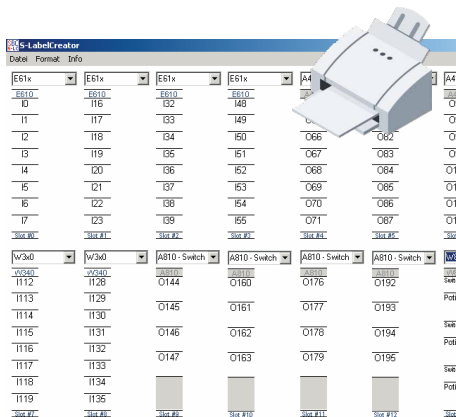

Fast labelling of I/O modules with the LabelEditor

The LabelEditor is included in the PG5 Controls Suite Device Configurator. This software tool is used to label PCD3 label clips efficiently.

EPLAN macros

EPLAN macros are available for project planning and engineering



The EPLAN® electric P8 macros are available on the support site. The macros and article data are also provided on the EPLAN® data portal.



Consumables and accessories for Saia PCD3.Mxxx0 controllers



Saia PCD3 battery and battery holder module

Type	Description
PCD3.R010	Battery kit for PCD3.M3x60 Basic CPU (battery module for slot #3 incl. lithium battery CR2032)
463948980	Battery holder module (for PCD3.M5x60 and PCD3.M6xx0)
450748170	Lithium battery for PCD Base CPU



Saia PCD3 housing covers

Type	Description
410474930	Cover for PCD3.M5x60 and PCD3.M6xx0
PCD3.E009	Empty module housing for unused PCD3 I/O slots
410475150	Slot cover for unused PCD3 I/O slots

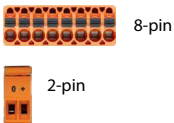

Saia PCD3 plug-in screw terminal blocks for basic modules and module holders

Type	Description
440549950	8-pin spring terminal block for power supply to PCD3.Mxxx0
440549520	Screw terminal 2-pin for supply PCD3.C200

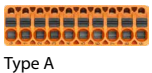

Type A

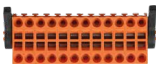

Type C



Type E



Type F



Type J



Type K

Saia PCD3 plug-in terminal blocks and labelling for I/O modules

Type	Description
440549540	Plug-in I/O spring terminal block 10 - pin for wires up to 2.5 mm ² type A
440549560	Plug-in I/O spring terminal block 24 - pin for wires up to 1.0 mm ² type C
440549980	Plug-in I/O spring terminal block 14 - pin for wires up to 1.5 mm ² type E
440549360	Plug-in I/O spring terminal block 12 - pin for PCD3.A810 for wires up to 1.5 mm ² type F
440549340	Plug-in I/O spring terminal block 8 - pin for PCD3.W800 for wires up to 1.5 mm ² type J
440550480	Plug-in I/O spring terminal block 10 - pin for wires up to 1.0 mm ² type K
431087230	Set of 10 units: Transparent snap-on label holder including neutral inscription labels (2x DIN A4)

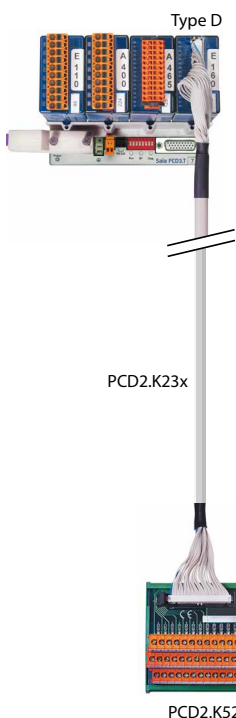

System cables and "ribbon screw terminal" adapters (see Chapter 5.10 for details)

Type	Description
System cables for digital modules with 16 I/Os	
PCD2.K221	Sheathed, round cable with 32 strands of 0.25 mm ² , 1.5 m long, PCD side 34-pin ribbon cable connector type D, process side: strand ends free, colour coded
PCD2.K223	Sheathed, round cable with 32 strands of 0.25 mm ² , 3.0 m long, PCD side 34-pin ribbon cable connector type D, process side: strand ends free, colour coded
System cables for adapters PCD2.K520/..K521/..K525	
PCD2.K231	Sheathed, half-round cable with 34 strands, each 0.09 mm ² , 1.0 m long, 34-pin ribbon connector at both ends type D
PCD2.K232	Sheathed, half-round cable with 34 strands, each 0.09 mm ² , 2.0 m long, 34-pin ribbon connector at both ends type D
System cables for 2 relay interfaces PCD2.K551/K552	
PCD2.K241	Sheathed, half-round cable with 34 strands, each 0.09 mm ² , 1.0 m long, PCD side 34-pin ribbon connector type D, process side two 16-pin ribbon connector
PCD2.K242	Sheathed, half-round cable with 34 strands, each 0.09 mm ² , 2.0 m long, PCD side 34-pin ribbon connector type D, process side two 16-pin ribbon connectors

"Ribbon/screw terminal" adapters

Type	Description
PCD2.K520	for 16 inputs/outputs, with 20 screw terminals without LED
PCD2.K521	for 16 inputs/outputs, with 20 screw terminals and LED (for source operation only)
PCD2.K525	for 16 inputs/outputs, with 3 x 16 screw terminals and LED (for source operation only)
PCD2.K551	Relay interface for 8 PCD transistor outputs with 24 screw terminals and LED
PCD2.K552	Relay interface for 8 PCD transistor outputs with 24 screw terminals, LED and manual control mode (on-off auto switch) and 1 output as feedback for manual control

1.2.2 Saia PCD3.T66x remote I/O stations

The Smart RIOs are more than just another Ethernet remote I/O system. They can be programmed like a PLC and are therefore the ideal solution for distributed automation in line with the lean philosophy. Smart RIOs can be equipped with PCD3 I/O modules and expanded with PCD3 I/O module holders up to 256 I/Os per RIO station.



Design of Saia PCD3.T66x: Smart RIO head station with 4 slots for I/O modules

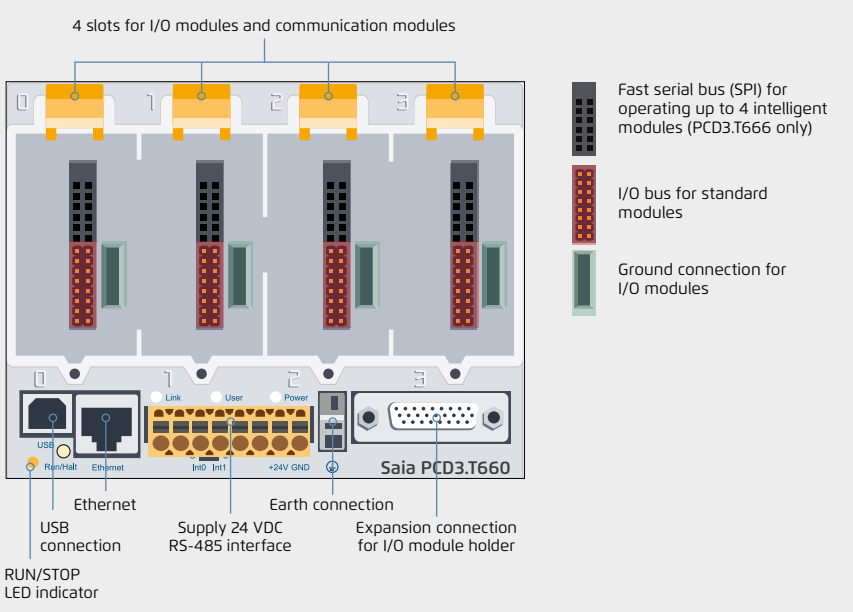

Dimensions

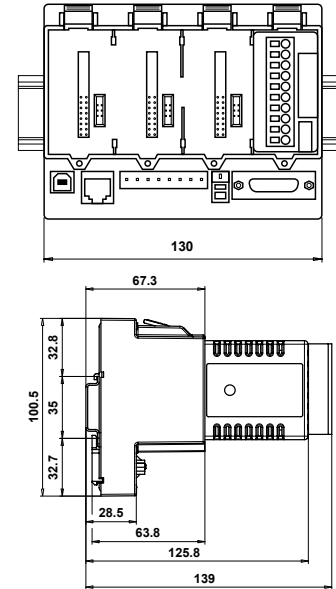

System properties

- ▶ Can be used as a simple remote I/O station or an intelligent programmable I/O station.
- ▶ Can be programmed with PG5. Important or time-critical tasks can be processed direct in the RIO.
- ▶ The RIO user programs are managed centrally in the Smart RIO Manager (PCD) and distributed to the RIOs automatically.
- ▶ Data exchange with efficient Ether S-IO protocol. Simple configuration with the RIO network configurator.
- ▶ Cross-communication with other PCD systems using Ether S-Bus (FBoxes).
- ▶ Intelligent communication modules (M-Bus, DALI) are supported with PCD3.T666.
- ▶ Other communication protocols (e.g. Modbus) via Ethernet TCP/IP and with PCD3.T666, also via the onboard RS-485 interface.
- ▶ Integrated Automation Server

I/O modules

The standard I/O modules of the PCD3 series can be used. For more information and types, see Chapter „Saia PCD3 input and output modules in cassette design“ on page 25.

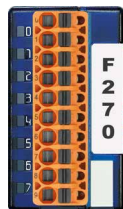

I/O extensions up to 256 I/O per RIO station

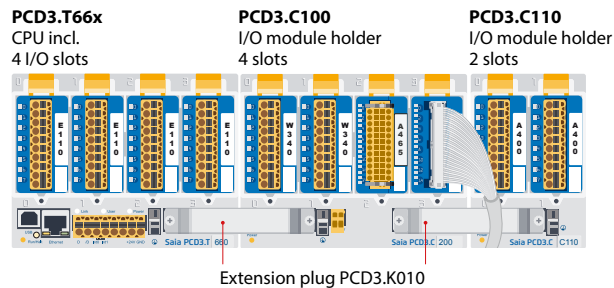

Order details

Smart RIO

PCD3.T665	Smart-RIO, Ether S-IO data exchange, programmable, 32 kByte program memory
PCD3.T666	Smart RIO, Ether S-IO data exchange, programmable, 128 kByte program memory, serial interfaces

I/O module holder

PCD3.C100	Expansion module holder with 4 I/O slots
PCD3.C110	Expansion module holder with 2 I/O slots
PCD3.C200	Expansion module holder with 4 I/O slots and terminals for 24 VDC power supply

Distributed automation system design with Smart RIO

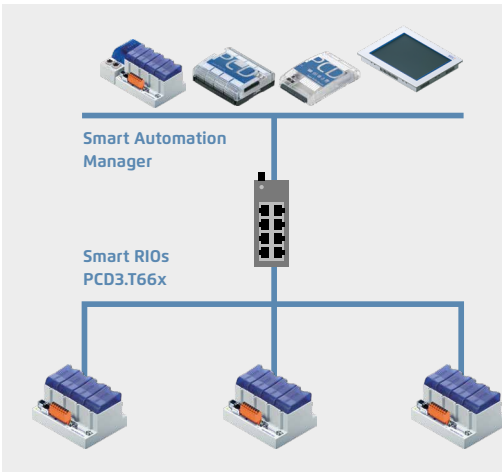

As Smart Automation Managers, PCD1.M21x0, PCD2.M5, PCD3.M3/5/6 CPUs and the programmable micro browser panel PCD7.D4xxxT5F can be used

Standard network components (e.g. Q.NET-5TX / 8TX) can be used to set up the Ethernet network

The maximum number of RIOs per Manager depends on the type of Manager used

The Smart RIOs can be used both as simple remote I/O stations and as intelligent programmable RIO stations.

Central program management in the Manager

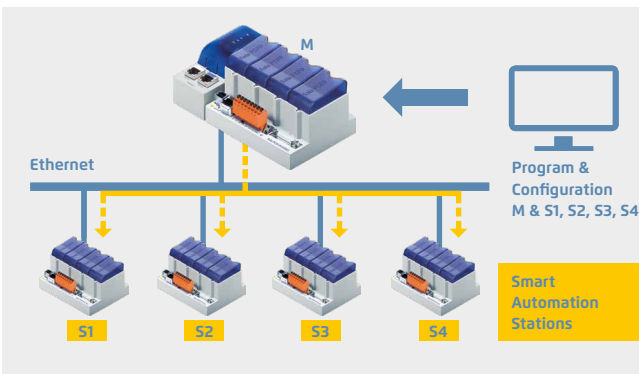

The application programs are centrally managed by the Smart Automation Manager and distributed to the Smart RIOs. If hardware is replaced, the programs and the configuration are reloaded automatically.

The Manager must have sufficient memory resources to save the RIO programs. The onboard program memory and the plug-in flash memory modules PCD7.Rxxx and PCD3.Rxxx can be used for this.

Data transfer with Ether S-IO protocol

The screenshot shows the 'SBC RIO Network Configurator - All' software interface. It displays a table for configuring data transfer between RIO stations. The table includes columns for RIO Name, IP Address, RIO Type, Description, Program, Enabled, RIO #, RIO ID, Diag ID, and Device File Path. Below this, there are sections for 'Media Mapping' and 'IO Mapping' with detailed settings for digital inputs and outputs for various RIO models like PCD3.T66x and PCD3.A40x.

Simple configuration of the data transfer in the RIO network configurator

The exchange of data can be easily configured in PG5 with the RIO network configurator. The configured exchange of data between RIO and the Manager is processed automatically by the operating system. No user program is required for this. The Manager sends the data to the Smart RIOs on a cyclical basis with broadcast or unicast telegrams. The RIOs also send their data or statuses of their inputs to the RIO Manager on a cyclical basis.

Data transfer cycle times

Number of RIOs	Minimum data transfer cycle time
10	50 ms
20	100 ms
40	200 ms
80	400 ms
128	800 ms

2 different transfer cycle times can be set per RIO station:

- Short cycle time for high-priority data
- Normal cycle time for low-priority or slow data

Technical Data

Property	PCD3.T665	PCD3.T666	
Number of inputs/outputs	64 in base unit, expandable to 256		
I/O module slots	4 in base unit, expandable to 16		
I/O modules supported	PCD3.Exxx, PCD3.Axxx, PCD3.Bxxx, PCD3.Wxxx		
max. number of RIO stations	128		
Protocol for data transfer	Ether S-I/O		
Ethernet connection	10/100 Mbits, full-duplex, auto-sensing, auto-crossing		
Default IP configuration	IP address: 192.168.10.100 Subnet mask: 255.255.255.0 Default gateway: 0.0.0.0		
USB interface for configuration and diagnostics	Yes		
Program memory	32 kByte	128 kByte	
Web server for configuration and diagnostics	Yes		
Web server for user pages	Yes		
Onboard file system for web pages and data	512 kByte		
BACnet®	No	No	
Onboard interrupt inputs	2		
Onboard RS-485 interface	No	Yes	
Special modules	for I/O slot 0 only	---	PCD3.F1xx
	for I/O slots 0...3 (up to 4 modules)	PCD3.H1xx counter	PCD3.H1xx counter
		---	PCD3.F261 DALI PCD3.F27x M-Bus
S-Web alarming/trending	No	No	
Watchdog	No		
Real-time clock	No		
Software clock (not battery-powered)	yes, synchronised by the Manager		
Battery	No		

Smart Automation Manager (master station)

max. 32 RIO stations	PCD1.M212x, PCD3.M3160, PCD3.M3360
max. 64 RIO stations	PCD1.M2160, PCD2.M4160, PCD7.D410VT5F, PCD7.D412DT5F
max. 128 RIO stations	PCD2.M4560, PCD3.M5360, PCD3.M5560, PCD3.M6860

General data

Supply voltage	24 VDC ±20% smoothed or 19 VAC ±15% two-way rectified
Capacity of 5 V bus / +V bus (24 V)	max. 600 mA/100 mA
Ambient temperature	0...+55 °C or 0...+40 °C (depending on mounting position)
Storage temperature	-20...+70 °C
Relative humidity	30...95% RH with no condensation
Mechanical strength	in accordance with EN/IEC 61131-2

System properties/limits and recommendations for lean automation

In the case of lean automation, it is inefficient to exploit the specified limits or max. number of stations per Manager and max. number of I/Os per RIO. The following points should be considered:



- ▶ The load on the RIO Manager increases with the rising number of RIO stations. This has an impact on the overall application in the RIO Manager.
- ▶ If there is a large number of RIOs, a sufficiently large volume of PCD media must be reserved on the Manager for the data transfer.
- ▶ With the increased number of RIO stations, the build and download process in PG5 is extended accordingly. Likewise, the start-up behaviour of the Manager or the entire RIO network is proportionately longer.

Recommendation: 20 Smart RIOs per Manager is an effective configuration for efficient and flawless operation and easy commissioning and support.

The Smart RIOs do not have a battery. In the event of an interruption to the power supply, all the data in the RAM memory (registers, flags, DBs/text) will be lost. Data and parameters that are remanent must either be transferred by the Manager or stored in the RIO's flash file system. If this is not possible, it is recommended to use a normal controller instead of a Smart RIO.

The user programs are stored in the flash memory of the RIOs and are retained in the event of an interruption to the power supply.

1.3 Standby System

With the PCD3.M6880 standby controllers, redundant automation solutions can be achieved. This helps to ensure uninterrupted operation of systems and processes.

1.3.1 PCD3.M6880

Modular PCD3 standby controller with 2 Ethernet TCP/IP ports and a coprocessor for standby operation.



Page 41

1.3.2 PCD3.T668

Smart RIO for standby system, for connection to the PCD3.M6880 CPU1.



43

Standby System Overview

Introduction

The PCD3.M6880 Standby Controllers are for creating redundant automation solutions, to ensure the uninterrupted operation of systems and processes.

Standby (redundant automation) systems from SBC have the following characteristics:

- ▶ Based on the modular and robust PCD3 family, using standard modules.
- ▶ Simple system architecture to reduce costs.
- ▶ Standby processors with shared Ethernet Remote I/Os avoids the duplication of the inputs/outputs and the sensors/actuators.
- ▶ Programmable remote I/Os create intelligent decentralized nodes to provide additional reliability.
- ▶ The network uses standard Ethernet components, and can run over a standard Ethernet TCP/IP network along with other services.
- ▶ Easy engineering and commissioning, using the PG5 Project Manager to automatically generate the project.
- ▶ Uninterrupted switching from Standby to Active device.
- ▶ Standby controllers contain two processors. One processor runs the redundant program and monitors the active PCD. The second independent processor runs other non-redundant processes. This significantly increases the performance and flexibility of the system.
- ▶ Comprehensive diagnostic features to aid commissioning and fault finding.

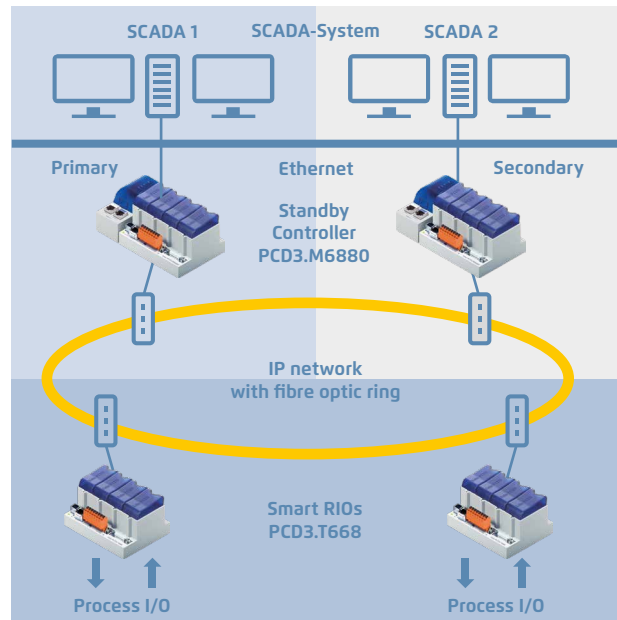

Typical layout of a redundancy system with two PCD3.M6880 Standby devices and PCD3.T668 Ethernet Smart RIOs.

Terminology

The following definitions will provide a better understanding of the properties and operating principles:

- Standby Controller** The PCD3.M6880 controller which supports the standby feature.
- Primary PCD** The PCD which becomes the active device by default when the system is powered up, depending on the configuration.
- Secondary PCD** The PCD which becomes the standby device on power up, and only takes over active control in the event of a fault on the active device.
- Active PCD** The PCD whose CPU1 is in Active Mode, running the redundant program and controlling the inputs/outputs (PCD3.T668 RIOs).
- Standby PCD** The PCD whose CPU1 is in Standby mode. It does not run the redundant program and the outputs (PCD3.T668 RIOs) are not controlled by this device.
- Main CPU** CPU0 of the Primary or the Secondary PCD, which runs the non-redundant program. This program may be different on the Primary and Secondary devices.
- Redundant CPU** CPU1 of the Primary or Secondary PCD, which contains the Redundant program. This program must be the same on the primary and Secondary devices. This CPU is either in Active mode and running the Redundant program, or in Standby mode and monitoring the Active PCD.

Redundant control solutions are created using two PCD3.M6880 Standby Controllers. The input/outputs (process signals) are connected and controlled via PCD3.T668 Ethernet smart RIOs. The RIO stations are connected to both controllers via an Ethernet connection. This means there is no need to have duplicate inputs, outputs, sensors and actuators. The two PCDs (primary and secondary) monitor each other. If the active PCD fails, the standby PCD takes over processing and control of the connected RIO stations. The process image (I/O) and the internal PCD media (F, R, T, C, DB) - the synchronization data - are continuously transferred from the active PCD to the standby PCD via the Ethernet connection. This ensures uninterrupted switching from the active to the standby PCD.

The Redundant CPU1 has two independent Ethernet interfaces. The ETH 2.x interface is reserved exclusively for operating the PCD3.T668 RIO stations. The PCDs also synchronize their process data via the same interface. For security reasons, we recommend setting up this network as a ring structure with specific network components from third-party providers. We have had good experiences with the industrial Ethernet switches from Hirschmann.



Ethernet 2
(2 port switch)

The ETH 1 interface on CPU0 is available for connecting and operating other systems and devices. For example, SCADA systems can be connected via this interface. SBC does not provide its own SCADA system for redundant automation solutions, but almost any system can be used. A single SCADA system, or an additional redundant SCADA system can be used if it supports redundant controllers. The PCD3.M6880 controllers provide detailed status and diagnostic information which can be evaluated by the SCADA systems.



Ethernet 1

Ordering Information

Type	Description	Weight
PCD3.M6880	Modular PCD3 standby controller with 2 Ethernet TCP/IP ports and a coprocessor for standby operation.	820 g
PCD3.T668	Smart RIO for standby system, for connection to the PCD3.M6880 CPU1.	480 g

Designing the System

Redundant automation solutions can be achieved with various network topologies.

Physically separating the management network (SCADA systems) and the network for the remote I/Os is recommended. We also recommend setting up the remote I/O network in a ring structure using fibre-optic network components. This significantly increases the performance, security and, above all, the network availability and thus the system reliability. Standard devices from third-party providers can be used for the network components (switches). We have had good experiences with the switches (RS30) from Hirschmann. However, the networks can also be set up with standard components in a star structure. A shared physical network for the remote I/Os and management systems is also possible, but availability of the system will be reduced accordingly.

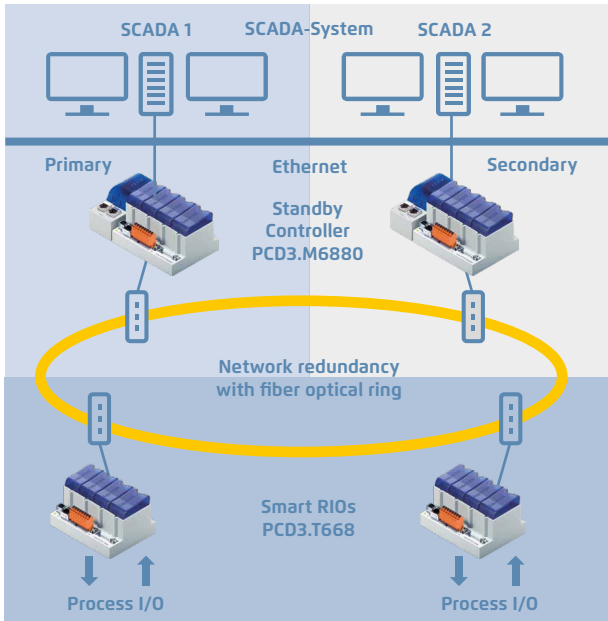

Recommended network topology with physically separate networks and a fibre-optic ring

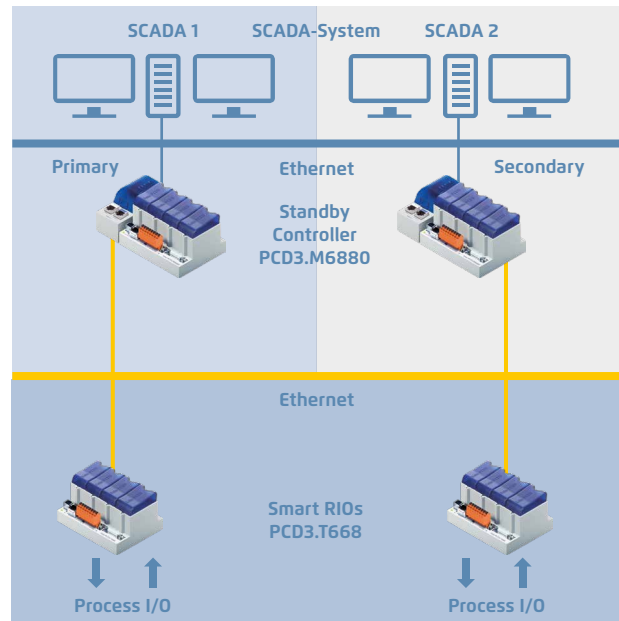

Physically separate networks in a star topology with standard components

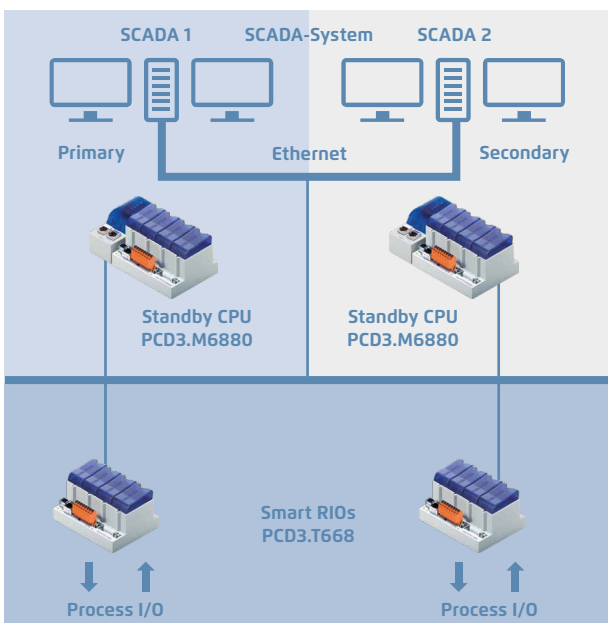

Shared physical network in a star topology with standard components

1.3.1 PCD3.M6880 Standby Controller Architecture of the PCD3.M6880

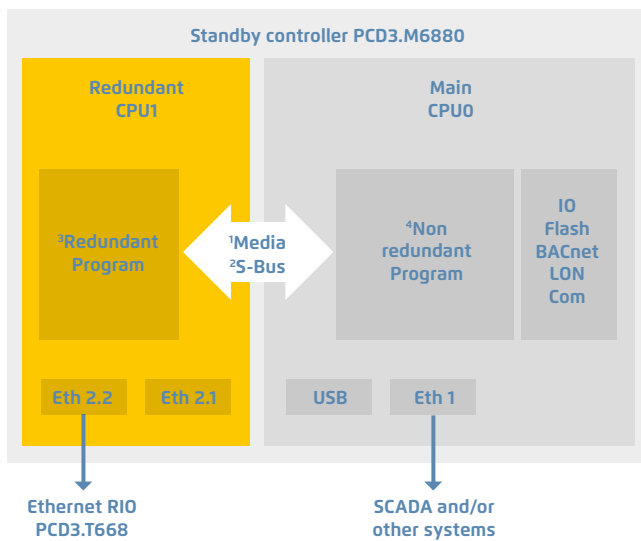

PCD3.M6880



- ¹ Data Media Transfer (Exchange Range or/and CSF/FBox)
- ² S-Bus GWY CPU0 to CPU1 (2 different S-Bus address)
- ³ Redundant program on CPU1 runs only if active. Same program on both PCDs.
- ⁴ Non-redundant program can be different in both PCDs.

The PCD3.M6880 standby controller has two independent processors (CPU0 and CPU1). Both processors have their own independent PCD media (F, R, T, C, DB/TX).

The redundant CPU1 runs the redundant user program and controls the shared inputs/outputs of the PCD3.T668 remote I/Os.

The redundant programs in the primary and secondary PCD3.M6880s are identical. During normal operation, only the active PCD runs the redundant program. CPU1's internal used PCD media (F, R, T, C, DB/TX) are transferred from the active to the standby PCD via the Ethernet interface 2 (ETH2.x). In the event of a fault, the standby PCD takes over operation without interruption, and runs the redundant program using the last process image from the active PCD.

Depending on requirements, the user programs of the main CPU0 can be different in the primary and secondary PCD3.M6880.

CPU0 has the same capabilities as a standard PCD (e.g. PCD3.M5560). Local I/Os in the PCD's slots, and the I/O expansion modules, are controlled by CPU0. External systems and devices (SCADA systems, web browsers and other external devices) communicate only with CPU0. CPU0's internal PCD media (F, R, T, C, DB) are not synchronized between the active and standby PCD.

CPU1's program cannot directly access the local I/Os or CPU0's media (and vice versa). Data is exchanged between CPU0 and CPU1 using a data exchange mechanism. The data to be exchanged (PCD media) are define in global symbol files. This data is automatically exchanged between CPU0 and CPU1 on each program cycle.

Saia PCD3.M6880 controllers

High Power Standby Controller

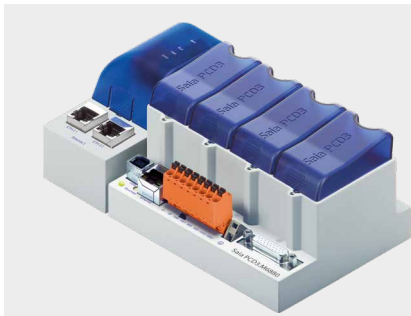

I/O	1023
File system	up to 4.2 GByte
Program	2 MByte
CPU Speed Basic Power	0.1/0.3 μ s bit/word

Property/function	PCD3.M6880	
	Main CPU0	Redundant CPU1
Number of inputs/outputs	1023	—
or I/O-module slots	64	—
I/O expansion connection for PCD3.C module holder	Yes	—
Processing time [μ s]	0.1...0.8 μ s	
bit operation	0.3 μ s	
word operation		
Real time clock (RTC)	Yes	

On-Board memory

Program memory, DB/TEXT (Flash)	2 MByte	
User memory, DB/TEXT (RAM)	1 MByte	128 KByte
Flash memory (Program, S-RIO and configuration)	128 MByte	
User flash file system (INTFLASH)	128 MByte	—
PCD media:		
Register	16384	16384
Flag	16384	16384
DB/TEXT	8192	8192

On-Board interfaces

USB 1.1	Yes	No
Ethernet 10/100 Mbit/s, full-duplex, auto-sensing/auto-crossing	ETH1	ETH2.x (2 port switch)
RS-485 on terminal block (Port 2) or RS-485 Profibus-DP Slave, Profi-S-Net on terminal block (Port 2)	up to 115 kbit/s up to 187.5 kbit/s	—

Optional communication interfaces

I/O slot 0: PCD3.F1xx modules for RS-232, RS-422, RS-485 and Belimo MP-Bus	Yes	No
I/O slot 0...3 up to 4 modules or 8 interfaces: PCD3.F2xx modules for RS-232, RS-422, RS-485, BACnet® MS/TP, Belimo MP-Bus, DALI and M-Bus	Yes	No

Other features

Communication protocols/systems (BACnet, Modbus, DALI, M-Bus...)	As PCD3.M6860 without 2nd Ethernet	No
Automation server (web server, FTP server, e-mail, SNMP, flash file system...)	Yes	No
Connection and operation of PCD3.T668 remote I/O	No	Yes
Number of supported RIO stations	—	64
Connection and operation of PCD3.T665/T666 remote I/O	Yes	No
Number of supported RIO stations	64	—
Access to the I/O slots in the basic housing as well as to the PCD3.Cxxx I/O terminal bases	Yes	No

Switchover Criteria

Each of the Standby PCDs (CPU1) sends a „Keep Alive“ telegram to its partner for supervision.

The STANDBY PCD switches to ACTIVE when:

- ▶ No Keep Alive telegram has been received within the „Keep alive timeout“ period defined with the Redundant CPU's Device Configurator. The „Keep Alive Timeout“ can be adjusted between 100...500 ms. By this the max. switchover latency is <100...500 ms.
- ▶ The ACTIVE PCD's state is not RUN or STOP (stops sending Keep Alive).
- ▶ A manual Switchover command is executed. This is only possible if the Primary device does not have priority, the „Primary device has priority“ option must be „No“.

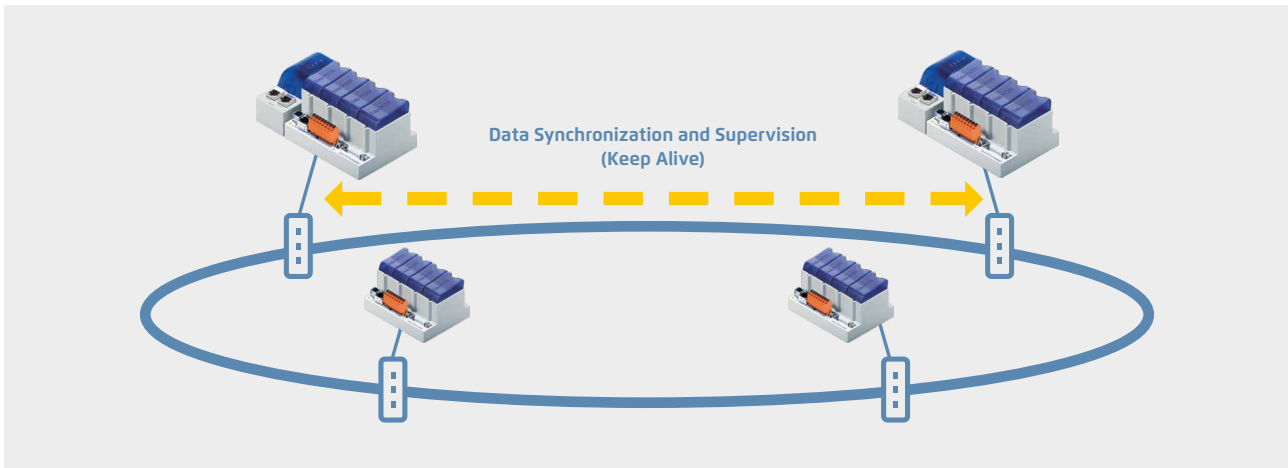

Data Synchronisation and Program Cycle:

The used PCD medias (R, F, T/C, DB/TX) in the redundant CPU1 are cyclically synchronized between the active and the standby PCD. The synchronization time for all PCD media is normally less than 200 ms. This time is reduced accordingly if only a part of the PCD media is used. The total program cycle time is calculated as follows:

Total cycle time = program execution time + data synchronization time

The max. value for a large application can be calculated as follows: 100 ms + 200 ms = 300 ms max.
For smaller applications where less PCD media are used the cycle time is reduced correspondingly.

1.3.2 PCD3.T668 Standby RIO Architecture of the PCD3.T668

The PCD3.T668 remote I/Os are exclusively for use with the PCD3.M6880 Standby Controllers. With the exception of the redundancy function, they support the same properties/functions as the PCD3.T666 remote I/O station. The PCD.T665 and PCD3.T666 standard remote I/Os cannot be used with Standby Controllers.

- ▶ Can be used as a simple local I/O station or an intelligent programmable I/O station
- ▶ Can be programmed with the PG5. Important or timecritical tasks can be processed directly in the RIO
- ▶ The RIO's user programs are managed centrally by the Smart RIO Manager (PCD) and downloaded to the RIOs automatically
- ▶ Data exchange uses the efficient Ether-S-IO protocol. Simple configuration with the RIO Network Configurator
- ▶ Cross-communication with other PCD systems using Ether-S-Bus (FBoxes)
- ▶ Intelligent communication modules (e.g. M-Bus, DALI) are supported
- ▶ Other communication protocols (e.g. Modbus) via Ethernet TCP/IP and also by the onboard RS-485 interface
- ▶ Integrated Web Server



Technical data

Property	PCD3.T668	
Number of inputs/outputs	64 in base unit, extensible to 256	
I/O-module slots	4 in base unit, extensible to 16	
I/O-modules supported	PCD3.Exxx, PCD3.Axxx, PCD3.Bxxx, PCD3.Wxxx	
Max. number of RIO stations	128	
Protocol for data transfer	Ether-S-IO	
Ethernet connection	10/100 Mbit/s, full-duplex, auto-sensing, auto-crossing	
Default IP configuration	IP address: 192.168.10.100 Subnet mask: 255.255.255.0 Default gateway: 0.0.0.0	
USB port for configuration and diagnostics	yes	
Program memory	128 kByte	
Web server for configuration and diagnostics	yes	
Web server for user pages	yes	
On-Board file system for web pages and data	512 kByte	
BACnet®	no	
On-Board interrupt inputs	2	
On-Board RS-485 interface	yes	
Special modules	for I/O-slot 0 only	PCD3.F1xx
	for I/O-slots 0...3 (up to 4 modules)	PCD3.H1xx counter PCD3.F261 DALI PCD3.F27x M-Bus
S-Web alarming/trending	no	
Watchdog	no	
Real-time clock	no	
Software clock (not battery-powered)	yes, synchronized by the Manager	
Battery	no	

General data

Supply voltage	24 VDC \pm 20 % smoothed or 19 VAC \pm 15 % full-wave rectified
Capacity of 5 V bus / 24 V bus	max. 650 mA/100 mA
Ambient temperature	0...+55 °C or 0...+40 °C (depending on mounting position)
Storage temperature	-20...+70 °C
Relative humidity	30...95 % RH with no condensation
Mechanical strength	according to EN/IEC 61131-2

System properties/limits and recommendations for lean automation

With lean automation, it is not recommended to make full use of the specified limits with regard to the maximum number of stations per Manager and the maximum number of I/Os per RIO. The following points should be taken into account:



- ▶ The load on the RIO Manager increases with the rising number of RIO stations. This has an impact on the overall application in the RIO Manager.
- ▶ If there is a large number of RIOs, a sufficiently large amount of PCD media must be reserved on the Manager for the data transfer.
- ▶ With a rising number of RIO stations, the build and download process in PG5 is lengthened accordingly. Likewise, the start-up behavior of the Manager or the entire RIO network is proportionately longer.

Recommendations: 20 Smart RIOs per Manager is a sensible configuration for efficient and problem-free operation, and simple commissioning and support.

The Smart RIOs do not have a battery. In the event of an interruption to the power supply, all the data in the RAM memory (registers, flags, DBs/text) will be lost. Data and parameters that are to remain must either be transferred by the Manager or stored in the RIO's flash file system. If this is not possible, the use of a normal controller in place of a Smart RIO is recommended. The user programs are stored in the flash memory of the RIOs and are retained in the event of an interruption to the power supply.

1.4 PCD2 – modular, expandable, compact CPU

Overview of fully programmable controllers Saia PCD2 device series

Saia PCD2 controllers

Base unit with 4 slots for I/O modules

- ▶ PCD2.M4160 Basic 64 I/Os
- ▶ PCD2.M4560 Extended 1023 I/Os

Base unit with 8 slots for I/O modules

- ▶ PCD2.M5540 Expanded with Ethernet switch

Up to 4 integrated communication interfaces. With plug-in modules expandable up to max.15 communication interfaces. Integrated Automation Server in all CPUs.



Page 46

Saia PCD2 module holder for I/O expansion

Module holder for I/O modules

- ▶ PCD2.C1000 4 I/O slots
- ▶ PCD2.C2000 8 I/O slots

Expandable up to 1023 I/Os



50

Saia PCD2 input/output modules

Modules with various functions with plug-in terminals

- ▶ PCD2.Exxx Digital input modules
- ▶ PCD2.Axxx Digital output modules
- ▶ PCD2.Bxxx Digital input/output modules
- ▶ PCD2.Wxxx Analogue input/output modules
- ▶ PCD2.Gxxx Combined input/output modules

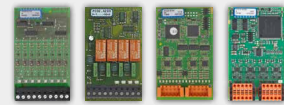

51

Saia PCD2 interface modules

Plug-in modules to expand the communication interfaces (up to 4 modules or 8 interfaces)

- ▶ PCD7.F1xxS 1 serial interface RS-232, RS-422/485, Belimo MP-Bus
- ▶ PCD2.F2xxx 2 serial interfaces RS-232, RS-422/RS-485
- ▶ PCD2.F2150 BACnet® MSTP
- ▶ PCD2.F2610 DALI
- ▶ PCD2.F27x0 M-Bus
- ▶ PCD2.F2180 Belimo MP-Bus



54

Saia PCD2 memory modules

Plug-in memory modules for data and program backup

- ▶ PCD2.R6xx Basic module for SD flash cards for slots 0...3
- ▶ PCD7.R-SD SD flash cards for PCD3.R6xx
- ▶ PCD7.R5xx Flash memory modules for slots M1 & M2
- ▶ PCD7.R610 Flash memory modules for slot M1 & M2



55

Consumables and accessories for Saia PCD2 controllers

Housing covers, plug-in screw terminal blocks, I/O bus connection, battery, system cables and adapters



57

Saia PCD2.M4xx controllers

The PCD2.M4x60 controller is based on a flat, space-saving housing design that has already been successfully used in the OEM and project business for many years. This modular, fully programmable CPU is suitable for both small and large applications, for example in machine controllers, building automation and infrastructure automation. The modular CPU is powerful, compact and can be expanded with up to 1,023 local data points. Generous memory resources and sufficient CPU power for demanding communication tasks with up to 14 interfaces (BACnet, Profibus, M-Bus, Modbus, DALI, etc.).



PCD2.M4560

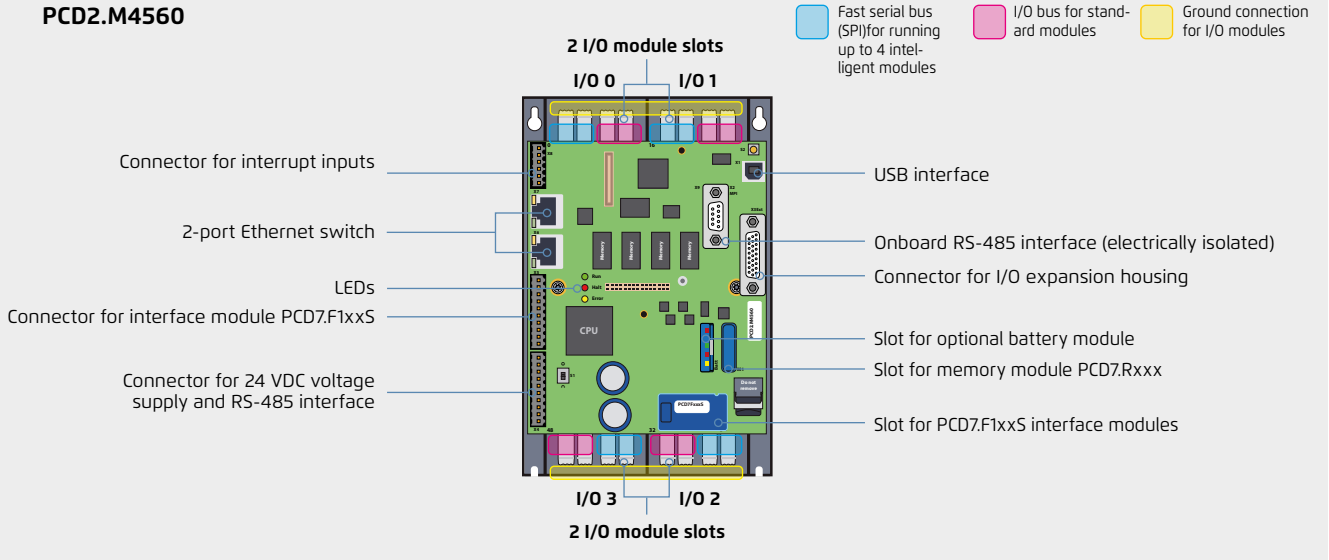

System properties

- ▶ Up to 14 communication interfaces
- ▶ 4 slots for PCD2 I/O modules in base unit
- ▶ Up to 64 inputs/outputs in base unit, can be expanded locally to up to 1,023 I/O
- ▶ Automation Server onboard
- ▶ Large onboard memory for programs (2 MB) and data (128 MB)
- ▶ Memory with SD flash cards can be expanded up to 4 GB
- ▶ Battery-free with FRAM technology – protects PCD media (R, F, DB/TEXT) from loss even in a de-energised state



Dimensions

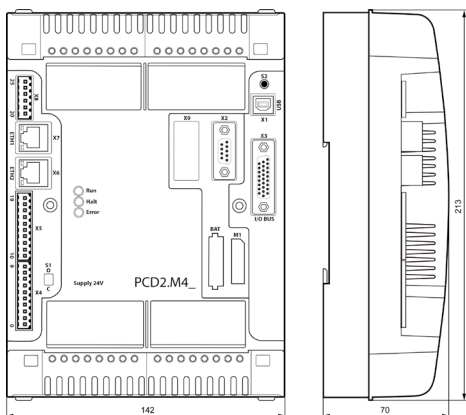

Compact mass:
142 × 213 × 49 mm

Mounting

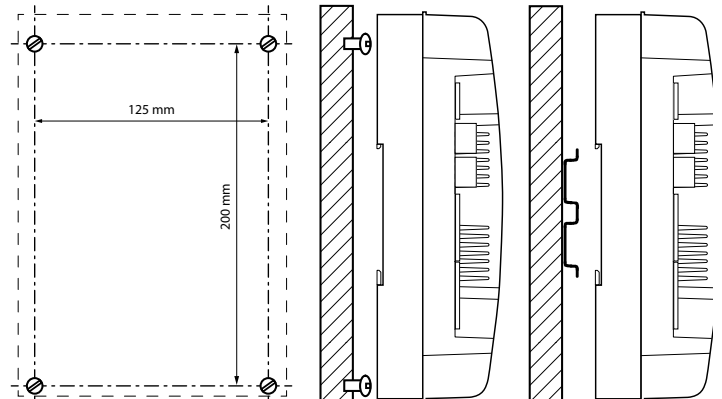

Screw diameter: less than Ø 4.9
Screw head diameter: less than Ø 8.0

Technical data and ordering information for PCD2.M4xxx controllers



Technical overview

Technical data	PCD2.M4160	PCD2.M4560
Number of digital inputs onboard	4 digital inputs (24 V, 4 × interrupt)	
Number of digital inputs/outputs in the base unit resp. I/O module slots in the base unit	64 4	
Number of digital inputs/outputs expandable with PCD2.C2000 and PCD2.C1000 module holders resp. I/O module slots		960 60
Processing time [μs]	Bit operation Word operation	0.1...0.8 μs 0.3 μs
Real-time clock (RTC)	Yes	
Supercap to support real-time clock	< 10 days	
Slot for optional battery holder module Order number 463948980	Yes, to support real-time clock for < 3 years	

Onboard memory

Program memory, DB/text (flash)	512 kB	2 MB
User memory, DB/text (RAM)	128 kB	1 MB
Flash memory (S-RIO, configuration and backup)	128 MB	128 MB
User flash file system (INTFLASH)	8 MB	128 MB
Data backup with FRAM technology (the data is retained in a de-energised state)	for R, F, DB, TEXT	for R, F, DB, TEXT

Onboard interfaces

USB 1.1	≤ 12 Mbit/s	
Ethernet, 2-port switch	≤ 10/100 Mbit/s, full duplex, auto-sensing/auto-crossing	
RS-485 on terminal block (port 0)	≤ 115.2 kbit/s	
RS-485 free protocols on D-Sub connector (port 2) or RS-485 Profibus-DP Slave, Profi-S-Net on D-Sub connector (port 10)	No	≤ 115.2 kbit/s ≤ 1.5 Mbit/s (elec. isolated)

Additional interfaces

PCD2.F2xxx modules for RS-232, RS-422, RS-485, BACnet MS/TP, Belimo MP-Bus, DALI and M-Bus	I/O slot 0...1 2 modules	I/O slot 0...3 4 modules
Slot A for PCD7.F1xxS modules	Yes	

General data

Supply voltage (in accordance with EN/IEC 61131-2)	24 VDC, -20/+25% max. incl. 5% ripple
Power consumption	typically 15 W for 64 I/Os
Load capacity 5 V/+ V internal	max. 800 mA/250 mA

Ordering information

Type	Description
PCD2.M4160	PCD2 processor unit with Ethernet TCP/IP, 512 kbytes program memory, 64 I/Os
PCD2.M4560	PCD2 processor unit with Ethernet TCP/IP, 2 MB program memory, 1,023 I/Os

- ♦ Accessories, e.g. connectors, covers, etc. are described in the last page of this chapter.
- ♦ Details can be found in the manual 27-645.

Saia PCD2.M5xxx controllers

Due to its flat housing design, the Saia PCD2.M5xxx is ideal for space-saving applications. The powerful CPU enables the control and regulation functions of complex applications with up to 1023 central data points. This allows the PCD2 to be expanded for Lon IP® or BACnet®-compatible controller using plug-in memory modules. The PCD2 has communication interfaces such as USB, Ethernet, RS-485 and onboard Automation Server.

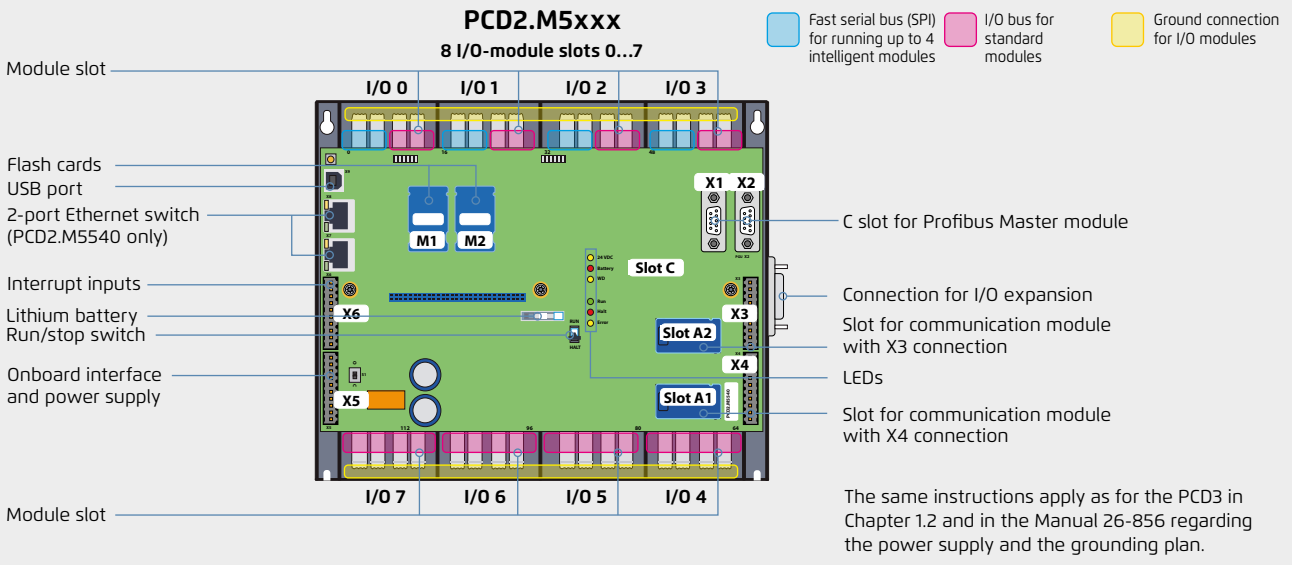

System properties

- ▶ Up to 15 communication interfaces (RS-232, RS-485, etc.)
- ▶ 8 I/O slots that can be expanded using module holders to max. 64 slots (1023 central data points)
- ▶ Remote I/O expansion with RIO PCD3.T66x (Ethernet)
- ▶ 1 MB of program memory
- ▶ Automation Server Onboard
- ▶ Data memory with flash memory modules that can be expanded to 4 GB
- ▶ 6 fast interrupt/counter inputs on the CPU
- ▶ Compatible with all PCD3 module holders

Onboard interfaces of the Saia PCD2.M5xxx

Type	Connection	Port	Transmission rate
RS-232 (serial) or RS-485 (serial)	X2 (D-Sub) X5 (terminal)	0	≤ 115.2 kbit/s
RS-485 (serial) for free protocols or Profi S-Net / Profibus DP Slave	X1 (D-Sub) X1 (D-Sub)	3 10	≤ 115.2 kbit/s ≤ 1.5 Mbit/s
Ethernet (2-port switch) (PCD2.M5540 only)	Ethernet	9	10/100 Mbit/s
USB 1.1 (PGU)	USB	---	≤ 12 Mbit/s

Dimensions

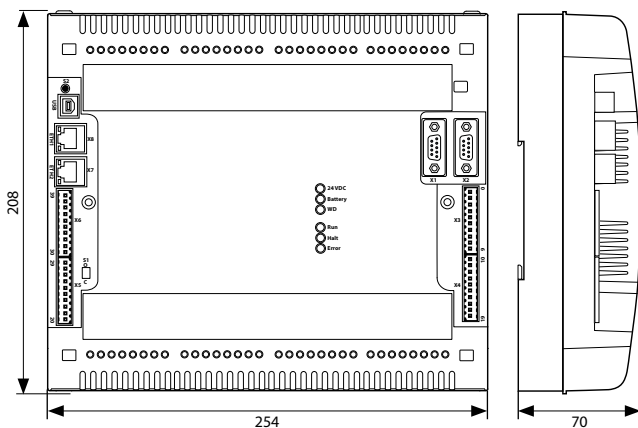

Mounting

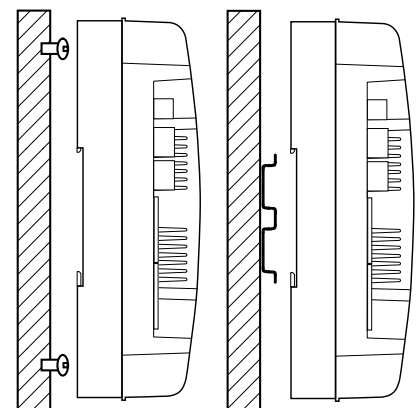

Technical data and ordering information for PCD2.M5xxx controllers



Technical overview

Technical data

Number of onboard digital inputs/outputs	6 digital inputs (24 V, 4 × interrupt) 2 digital outputs (2 × PWM, 24 V 100 mA)
Number of digital inputs/outputs in the base unit or I/O module slots in the base unit	128 8
Number of digital inputs/outputs with 7 PCD2.C2000 module holders or I/O module slots	896 56
Processing times [μs]	bit operation word operation
	0.3...1.5 μs 0.9 μs
Real-time clock (RTC)	Yes

Onboard memory

Main memory (RAM) for program and DB/Text	1 MB
Flash memory (S-RIO, configuration and backup)	2 MB
User flash file system (INTFLASH)	No
Data backup	1...3 years with lithium battery

Onboard communication interfaces

RS-232, RS-485 / PGU	≤ 115 kbit/s
RS-485 Profibus DP-Slave, Profi S-Net (S-IO, S-Bus)	≤ 1.5 Mbit/s
USB 1.1 (PGU)	≤ 12 Mbit/s
Ethernet, 2-port switch (PCD2.M5540 only)	≤ 10/100 Mbit/s (full duplex, auto-sensing/auto-crossing)

General specifications

Supply voltage (in accordance with EN/IEC 61131-2)	24 VDC, -20/+25% max. incl. 5% ripple
Load capacity 5 V / + V internal	max. 1400 mA / 800 mA
Automation Server	Flash memory, file system, FTP and web server, email, SNMP

Order details

Type	Description
PCD2.M5540	Programmable controller, 1024 kByte of RAM, Ethernet interface

Additional accessories, e.g. connectors, covers, etc. are described on the last page of this Chapter.

Saia PCD2.Cxxxx module holder

Up to 8 Saia PCD2.C1000 or Saia PCD2.C2000 module holders can be connected to the Saia PCD2.M4x60 (7 with PCD2.M5xxx). This makes it possible to connect up to 64 I/O modules or 1023 digital I/Os. A module holder has space for 4/8 I/O modules. In addition to Saia PCD2.Cxxxx module holders, all Saia PCD3 module holders can also be connected.

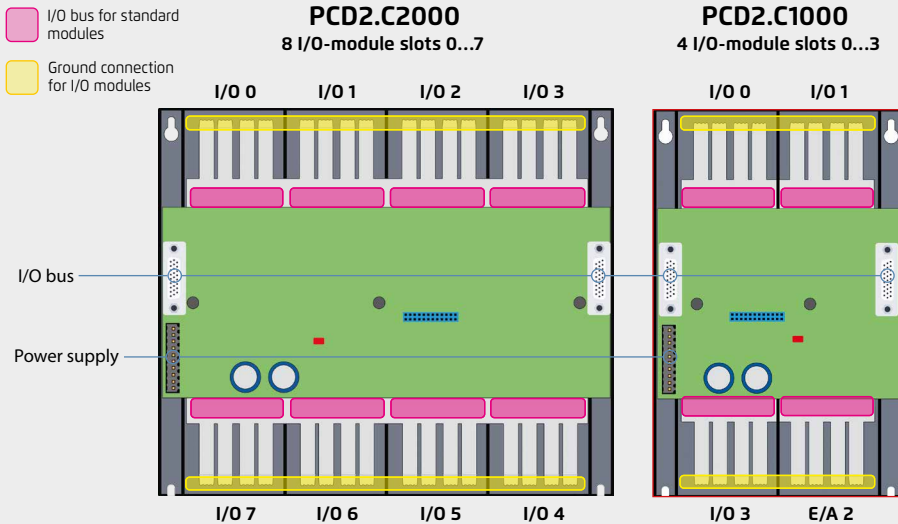

System properties

- ▶ Up to 1023 central data points
- ▶ Numerous module variants can be plugged in
- ▶ Mounting is quick and easy
- ▶ Can be combined with Saia PCD3.Cxxx module holders
- ▶ Connections for a power supply on each module holder
- ▶ Can be connected below or next to each other

Dimensions PCD2.C2000

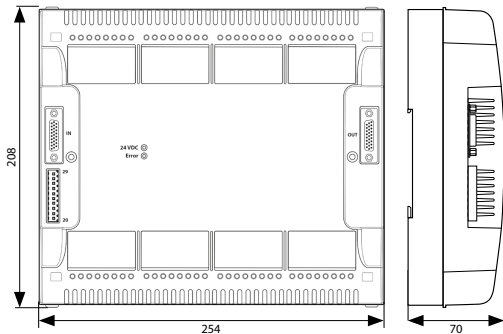

Dimensions PCD2.C1000

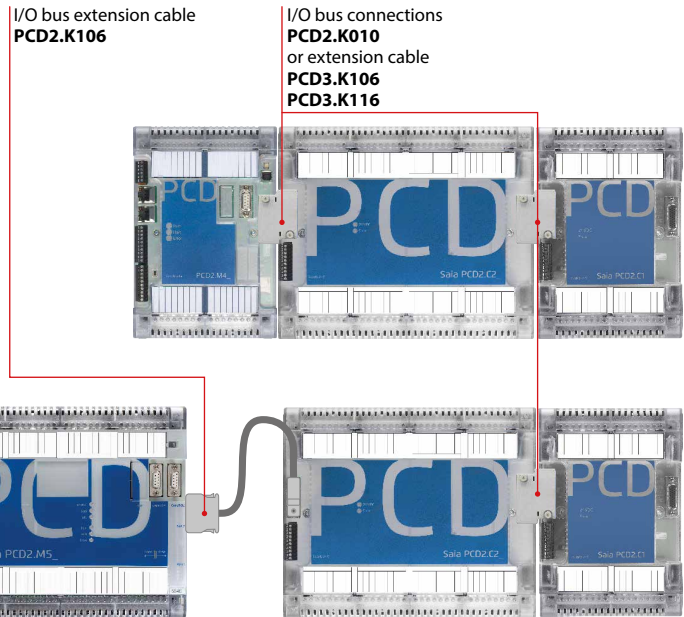
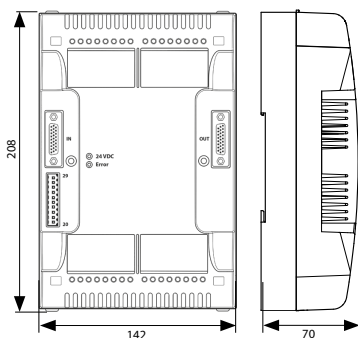

PCD2.M5x40 to PCD2.Cx000	PCD2.M4x60 to PCD2.Cx000	PCD2.Cx000 to PCD2.Cx000
PCD2.K106	PCD2.K010 PCD3.K106 PCD3.K116	PCD2.K010 PCD3.K106 PCD3.K116

Saia PCD2 I/O module holder

Type	Description
PCD2.C1000	Expansion module holder with 4 I/O slots
PCD2.C2000	Expansion module holder with 8 I/O slots
PCD2.K010	I/O bus connector
PCD2.K106	I/O bus extension cable length 0.9 m (connection between PCD2.M5xxx and PCD2.Cxxxx)
PCD3.K106	I/O bus extension cable length 0.7 m (connection between two module holders)
PCD3.K116	I/O bus extension cable length 1.2 m (connection between two module holders)

No more than 5 extension cables may be used for this.

Overview of Saia PCD2 plug-in I/O modules

The functions of the Saia PCD2 can be expanded as required using a wide range of plug-in I/O modules and adapted to specific needs. This not only ensures that a project can be implemented quickly, but also provides the option of expanding the system at any time during operation.

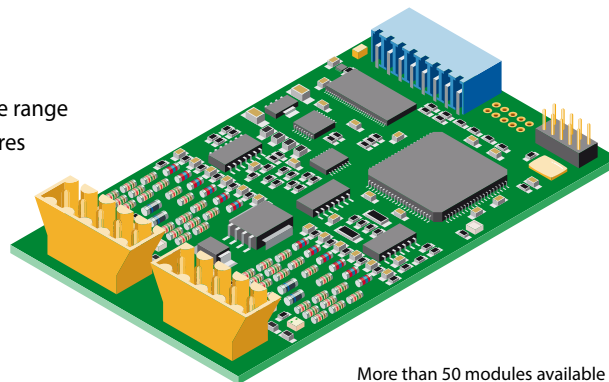

More than 50 modules available with different functionalities

System properties

- ▶ Numerous variants available
- ▶ Slot direct in the Saia PCD2.M4x60, PCD2.M5540, PCD1.M2xxx or on the module holder
- ▶ Full integration into the Saia PCD2 housing
- ▶ Compact design
- ▶ Up to 16 I/Os per module
- ▶ Modules with an input delay of 0.2 ms

General type key

- PCD2.Axxx Digital output modules
- PCD2.Bxxx Combined digital input/output modules
- PCD2.Exxx Digital input modules
- PCD2.Fxxx Communication modules
- PCD2.Hxxx Fast counter modules
- PCD2.Rxxx Memory modules
- PCD2.Wxxx Analogue input/output modules

Insertion into housing

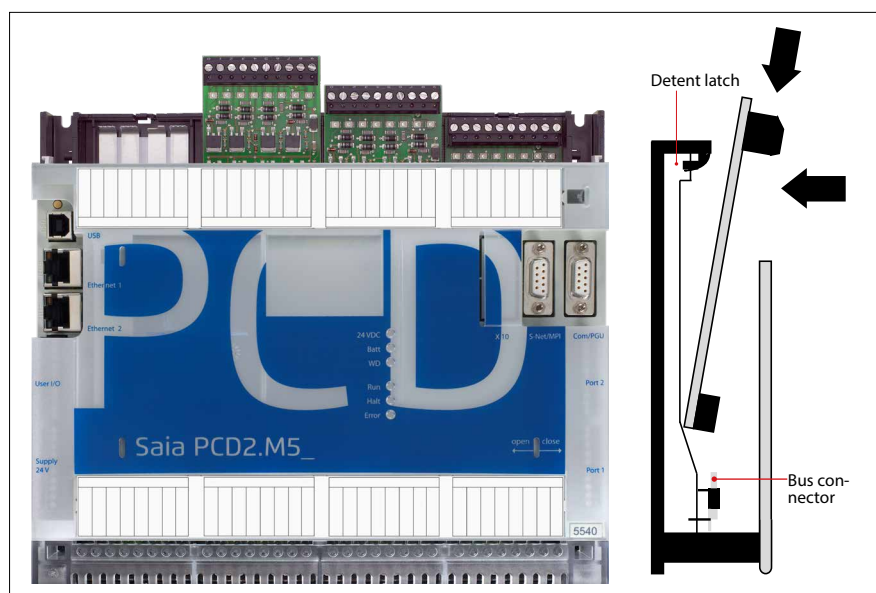

Slots for I/O modules

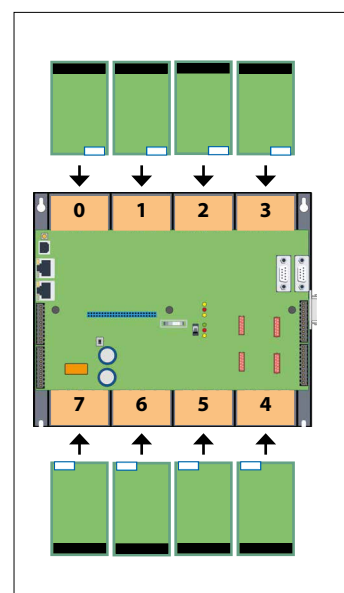

Differences between the terminals of the I/O modules

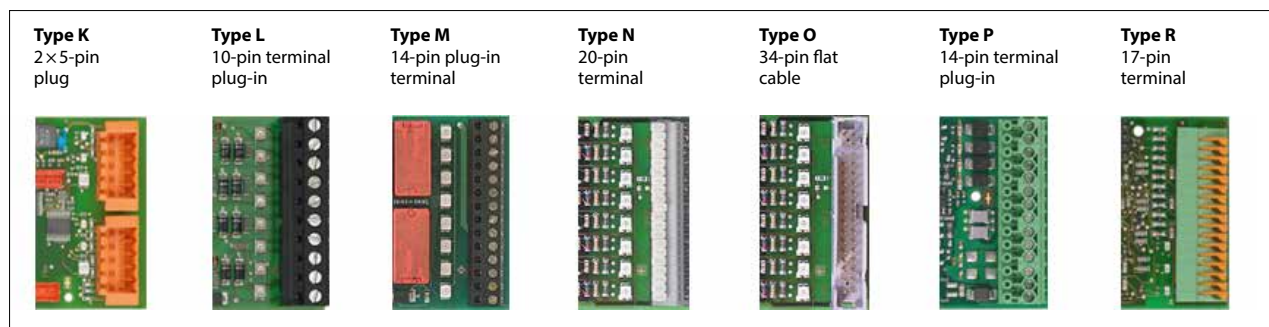

The screw terminal blocks and connectors can also be ordered individually as accessories.

Saia PCD2 digital input and output modules

The digital I/O modules can be easily plugged into Saia PCD2 and Saia PCD1 base units or a suitable I/O module holder. In addition to inputs for various voltage levels, digital outputs are provided with both transistor construction and as mechanical relays. This means that electrical isolation from the switching electrical circuit can be achieved easily and reliably.

Digital input modules

Type	Number of inputs	Input voltage	Switching capacity		Input filter	Electrical isolation	Current draw		I/O connector type ³⁾
			DC	AC			5V-Bus ¹⁾	+V-Bus ²⁾	
PCD2.E110	8	15...30 VDC	---	---	8 ms	---	24 mA	---	L
PCD2.E111	8	15...30 VDC	---	---	0.2 ms	---	24 mA	---	L
PCD2.E160	16	15...30 VDC	---	---	8 ms	---	72 mA	---	O
PCD2.E161	16	15...30 VDC	---	---	0.2 ms	---	72 mA	---	O
PCD2.E165	16	15...30 VDC	---	---	8 ms	---	72 mA	---	N
PCD2.E166	16	15...30 VDC	---	---	0.2 ms	---	72 mA	---	N
PCD2.E610	8	15...30 VDC	---	---	10 ms	●	24 mA	---	L

Digital output modules

Type	Number of outputs	Input voltage	Switching capacity		Input filter	Electrical isolation	Current draw		I/O connector type ³⁾
			DC	AC			5V-Bus ¹⁾	+V-Bus ²⁾	
PCD2.A200	4, relay (make with contact protection)	---	2 A/50 VDC	2 A/250 VAC	---	●	15 mA	---	L
PCD2.A220	6, relay (make)	---	2 A/50 VDC	2 A/250 VAC	---	●	20 mA	---	L
PCD2.A250	8, relay (make)	---	2 A/50 VDC	2 A/48 VAC	---	●	25 mA	---	M
PCD2.A400	8, transistor	---	0.5 A/5...32 VDC	---	---	---	25 mA	---	L
PCD2.A410	8, transistor	---	0.5 A/5...32 VDC	---	---	●	24 mA	---	L
PCD2.A460	16, transistor (with short circuit protection)	---	0.5 A/10...32 VDC	---	---	---	74 mA	---	O
PCD2.A465	16, transistor (with short circuit protection)	---	0.5 A/10...32 VDC	---	---	---	74 mA	---	N

Digital input/output modules

Type	Number of I/Os	Input voltage	Switching capacity		Input filter	Electrical isolation	Current draw		I/O connector type ³⁾
			DC	AC			5V-Bus ¹⁾	+V-Bus ²⁾	
PCD2.B100	2 In + 2 Out + 4 selectable In or Out	15...32 VDC	0.5 A/5...32 VDC	---	8 ms	---	25 mA	---	L
PCD2.B160	16 I/O (in blocks of 4 configurable)	24 VDC	0.25 A/18...30 VDC	---	8 ms or 0.2 ms	---	120 mA	---	2× K

Fast counter modules

Type	Number of counters	Inputs per counter	Outputs per counter	Counting range	Selectable digital filter	Current draw		I/O connector type ³⁾
						5V-Bus ¹⁾	+V-Bus ²⁾	
PCD2.H112	2	2 In + 1 configurable In	1 CCO	0...16 777 215 (24 bit)	10 kHz...150 kHz	50 mA	4 mA	K
PCD2.H114	4	2 In + 1 configurable In	1 CCO	0...16 777 215 (24 bit)	10 kHz...150 kHz	50 mA	4 mA	2× K



The internal load current drawn by the I/O modules from the +5V and +V bus supply must not exceed the maximum supply current specified for the PCD2.M4x60, PCD2.M5540, PCD2.Cxxxx and PCD1.M2xxx.

Overview of the internal bus capacity of the module holders

Capacity	PCD1.M2xxx	PCD2.M4x60	PCD2.M5540	PCD2.C1000	PCD2.C2000
¹⁾ Internal 5V bus	500 mA	800 mA	1400 mA	1400 mA	1400 mA
²⁾ Internal +V (24 V)	200 mA	250 mA	800 mA	800 mA	800 mA

The electrical requirement of the internal +5V and +V bus for the I/O modules is calculated in the PG5 2.1 Device Configurator.

³⁾ Plug-in I/O terminal blocks are supplied with I/O modules. Spare terminals, ribbon connectors with system cables and separate terminals are ordered as accessories (see pages 57 and 150).

Saia PCD2 analogue input and output modules

The numerous analogue modules allow complex control tasks or measurements. Depending on the speed of the AD converter, the resolution is between 8 and 16 bits. The digitised values can be processed further direct in the project in the PCD2 and PCD1. The large number of different modules means that the most suitable module is available for almost any requirement.

Analogue input modules

Type / Order no.	Number of channels	Signal range	Resolution	Electrical isolation	Current draw		I/O connector type ³⁾
					5V-Bus ¹⁾	+V-Bus ²⁾	
PCD2.W200	8 In	0...+10 V	10 bits	---	8 mA	5 mA	L
PCD2.W210	8 In	0...20 mA (4...20 mA via user program)	10 bits	---	8 mA	5 mA	L
PCD2.W220	8 In	Pt1000: -50°C...400°C/Ni1000: -50°C...+200°C	10 bits	---	8 mA	16 mA	L
PCD2.W300	8 In	0...+10 V	12 bits	---	8 mA	5 mA	L
PCD2.W310	8 In	0...20 mA (4...20 mA via user program)	12 bits	---	8 mA	5 mA	L
PCD2.W340	8 In	0...+10 V/0...20 mA (4...20 mA via user program) Pt1000: -50°C...400°C/Ni1000: -50°C...+200°C	12 bits	---	8 mA	20 mA	L
PCD2.W350	8 In	Pt100: -50°C...+600°C/Ni100: -50°C...+250°C	12 bits	---	8 mA	30 mA	L
PCD2.W360	8 In	Pt1000: -50°C...+150°C	12 bits	---	8 mA	20 mA	L
PCD2.W380	8 In	0-10 V...+10 V, -20 mA...+20 mA, Pt/Ni1000, Ni1000 L&S, NTC10k/NTC20k (configuration via software)	13 bits	---	25 mA	25 mA	2x K
PCD2.W315	7 In	0...20 mA (4...20 mA via user program)	12 bits	•	60 mA	0 mA	P
PCD2.W745	4 In	Temperature module for TC type J, K and 4-wire Pt/Ni 100/1000	16 bits	•	200 mA	0 mA	R

Analogue output modules

Type Order no.	Number of channels	Signal range	Resolution	Electrical isolation	Current draw		I/O connector type ³⁾
					5V-Bus ¹⁾	+V-Bus ²⁾	
PCD2.W400	4 Out	0...+10 V	8 bits	---	1 mA	30 mA	L
PCD2.W410	4 Out	0...+10 V/0...20 mA/4...20 mA jumper-selectable	8 bits	---	1 mA	30 mA	L
PCD2.W600	4 Out	0...+10 V	12 bits	---	4 mA	20 mA	L
PCD2.W610	4 Out	0...+10 V/-10 V...+10 V/0...20 mA/4...20 mA selectable with jumper	12 bits	---	110 mA	0 mA	L
PCD2.W605	6 Out	0...+10 V	10 bits	•	110 mA	0 mA	P
PCD2.W615	4 Out	0...20 mA/4...20 mA, configurable	10 bits	•	55 mA	0 mA	P

Analogue input/output modules

Type / Order no.	Number of channels	Signal range	Resolution	Electrical isolation	Current draw		I/O connector type ³⁾
					5V-Bus ¹⁾	+V-Bus ²⁾	
PCD2.W525	4 In + 2 Out	I: 0...10 V, 0(4)...20 mA, Pt 1000, Pt 500 or Ni 1000 (selectable by DIP switch) O: 0...10 V or 0(4)...20 mA (selectable by software)	In: 14 bits Out: 12 bits	•	40 mA	0 mA	P

Saia PCD2 mixed digital and analogue input and output modules

With the multi-function I/O module PCD2.G200 a total of 24 digital and analogue inputs and outputs is achieved. Thus, the need for additional module holders can be avoided, and sophisticated small applications can be implemented cost-effectively.

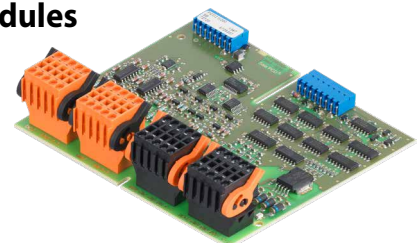

Multifunctional input/output modules

Type / Order no.	Number of channels	Signal range	Resolution	Input filter	Electrical isolation	Current draw		I/O connector type ³⁾
						5V-Bus ¹⁾	+V-Bus ²⁾	
PCD2.G200	4 In	Digital: 15...30 VDC		8 ms	---	12 mA	35 mA	KB black
	4 Out	Digital: 0.5 A/10...32 VDC			---			KB black
	2 In 2 In 4 In	Analogue: 0...10 V Analogue: Pt1000 or Ni1000 Analogue: Universal, 0...10 V, 0...20 mA, Ni/Pt1000 (selectable via DIP switch)	12 bits 12 bits 12 bits	10 ms 20 ms 10 ms Ni/Pt 20 ms	---		K orange	
	8 Out	Analogue: 0...10 V	10 bits		---		K orange	

¹⁾ ²⁾ ³⁾ See page 57

Communication interfaces of the Saia PCD2 controllers

In addition to the onboard interfaces of Saia PCD2, the interface functions can also be expanded in a modular way with various slots. The PCD2 series therefore supports numerous protocols. The physical bus specifications are available for most protocols as a plug-in module. If this is not the case, the bus can be connected via an external converter.

Protocols supported by the PCD2.M4x60, PCD2.M5540 via FBoxes

- ▶ Modem communication with the PCD
- ▶ HMI editor applications with PCD7.Dxxx text terminals
- ▶ Serial S-Net (S-Bus)
- ▶ Modbus
- ▶ JCI N2-Bus
- ▶ KNX® S-Mode/EIB (with external converter)
- ▶ DALI
- ▶ EnOcean (with external converter)
- ▶ M-Bus
- ▶ BACnet®

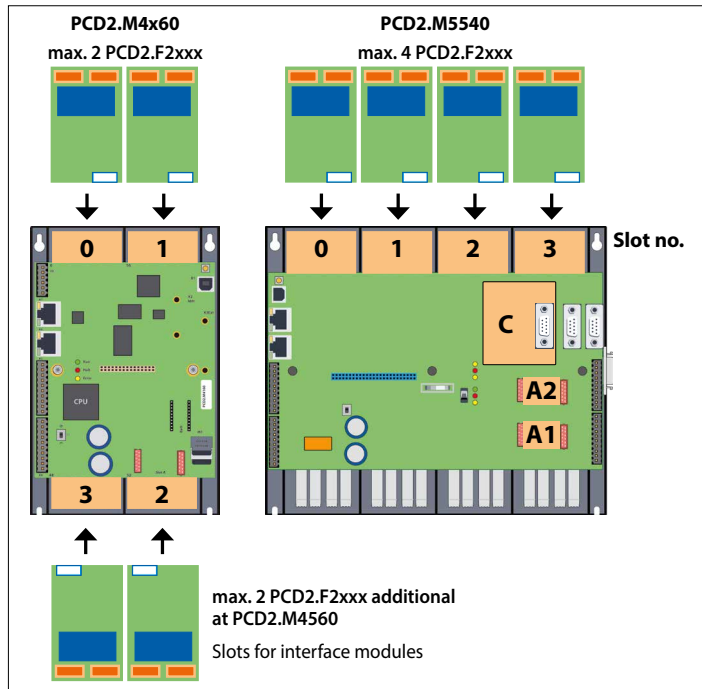
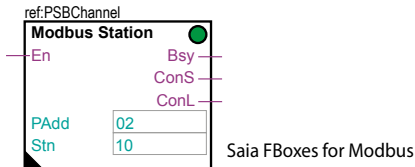

Physical interfaces that can be fully programmed



PCD7.F150S



PCD2.F2150 with PCD7.F150S

Module	Specifications	Electrical isolation	Current draw 5V-Bus +V-Bus		Slot	I/O connector type ¹⁾
PCD7.F110S	RS-422 with RTS/CTS or RS-485 ²⁾	---	40 mA	---	A1 / A2	
PCD7.F121S	RS-232 with RTC/CTS, DTR/DSR, DCD, suitable for modem or EIB connection	---	15 mA	---	A1 / A2	
PCD7.F150S	RS-485 ²⁾	•	130 mA	---	A1 / A2	
PCD2.F2100	RS-422/RS-485 ²⁾ , plus PCD7.F1xxS as an option	---	110 mA	---	I/O 0-3	2x K
PCD2.F2210	RS-232 plus PCD7.F1xxS as option	---	90 mA	---	I/O 0-3	2x K

Physical interfaces for specific protocols



PCD2.F2210



PCD2.F2150



PCD2.F2810

Module	Specifications	Electrical isolation	Current draw 5V-Bus +V-Bus		Slot	I/O connector type ¹⁾
PCD7.F180S	Belimo MP-Bus, for connecting up to 8 drives on one line	---	15 mA	15 mA	A1 / A2	
PCD2.F2150	BACnet® MS/TP or fully programmable	---	110 mA	---	I/O 0-3	2x K
PCD2.F2610	DALI	---	90 mA	---	I/O 0-3	L
PCD2.F2700	M-Bus 240 nodes	---	70 mA	8 mA	I/O 0-3	L
PCD2.F2710	M-Bus 20 nodes	---	70 mA	8 mA	I/O 0-3	L
PCD2.F2720	M-Bus 60 nodes	---	70 mA	8 mA	I/O 0-3	L
PCD2.F2810	Belimo MP-Bus with base for PCD7.F1xxS modules	---	90 mA	15 mA	I/O 0-3	2x K

¹⁾ Plug-in I/O terminal blocks are included with I/O modules. Spare terminals, ribbon connectors with system cables and separate terminals are ordered as accessories (see pages 57 and 150).

²⁾ with line termination resistors that can be activated.

³⁾ For 254 network variables, with base for PCD7.F1xxS modules.

System properties of PCD2.F2xxx modules

The following points must be noted when using the PCD2.F2xxx interface modules:

- ▶ Up to 4 PCD2.F2xxx modules (8 interfaces) can be used in slots 0...3 for each PCD2 system.
- ▶ The PCD2 system has a processor to process both the application and the serial interfaces. Processing of the interface modules requires the appropriate CPU capacity.
- ▶ Consult the information and examples provided in the Manual 26-856 for PCD2.M5 to determine the maximum communication capacity for each PCD2.M5 system.

Memory modules of the Saia PCD2 controllers

The functions of the Saia PCD2 can be expanded using flash memory. Memory cards with file systems and data backup are available for this task. The various protocols whose firmware is installed on the flash cards can also be used by simply inserting the relevant card. The controller therefore becomes BACnet® compatible. More information to memory management and structure is contained in Chapter 1.1 Saia PCD System Description.

System properties

Onboard user memory:

- ▶ 1024 kByte RAM for program + DB/text
- ▶ 2 MB flash memory (S-RIO, configuration and backup)

Expansion options:

- ▶ Two slots (M1 and M2) for memory cards integrated into the CPU

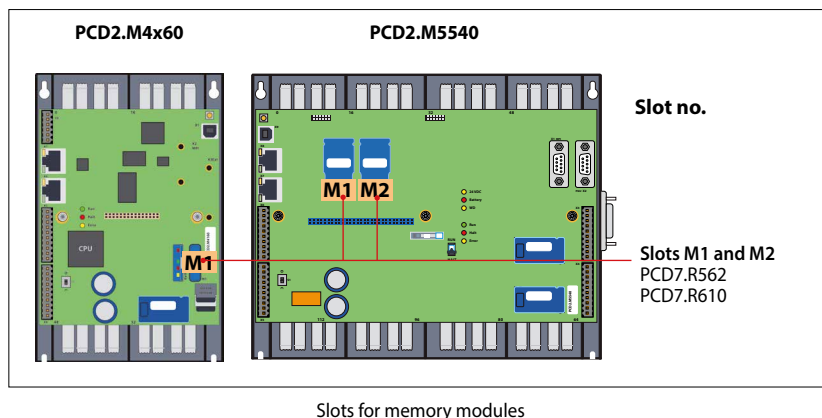

Flash memory with file system, program and data backup, BACnet®

Type	Description	Slot
PCD7.R562	Flash card with BACnet® and 128 MB file system	M1 & M2
PCD7.R610	Holder module for micro SD card	M1 & M2
PCD7.R-MSD1024	MicroSD memory card 1 GB, PCD formatted	PCD7.R610



Battery for data backup

Type	Description
463948980	Battery holder module for PCD2. M4x60
450748170	Lithium battery for PCD processor unit (RENATA button battery type CR 2032)



System properties of PCD7.R562 modules

- ▶ Only one BACnet® module can be operated per PCD2.M5540.

Consumables and accessories for Saia PCD2 controllers

Fast labelling of I/O modules with the Saia LabelEditor

The software tool efficiently labels the PCD2 labelling strip. The user can enter the unique data point text in the tool. This can then be printed out on A4 paper. The user selects appropriate distance formats for the various types of PCD2 modules. The text entered can be saved as templates and reused.

SBC Label Editor is delivered with the PG5 Controls Suite.

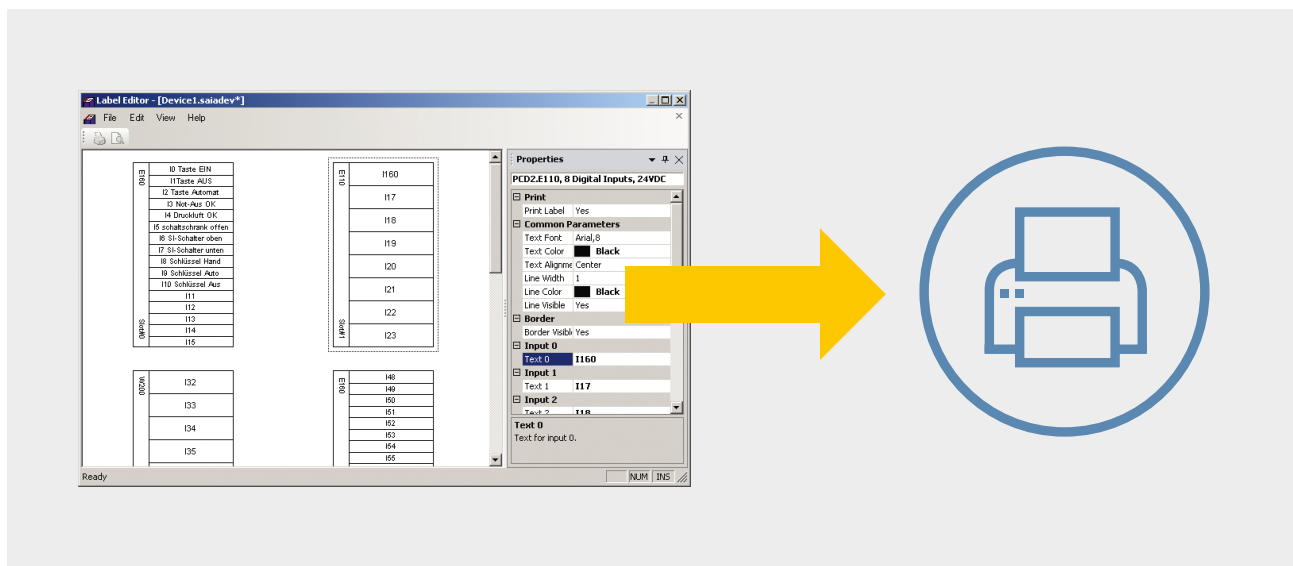
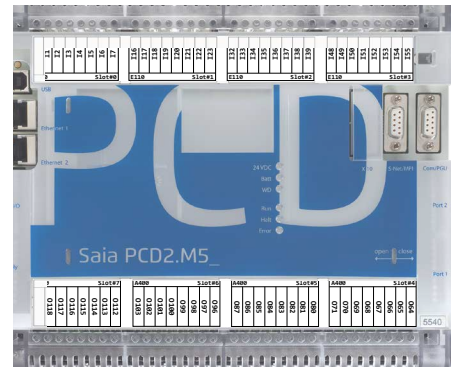

EPLAN macros

EPLAN macros are available for project planning and engineering



The EPLAN® electric P8 macros are available on the support site.

The macros and article data are also available on the EPLAN® data portal.



Download:
www.sbc-support.com

Consumables and accessories for Saia PCD2 controllers

Saia PCD2 housing covers



Type	Description
410477190	Cover for PCD2.M5x40 without logo (neutral housing cover)

Saia PCD2 plug-in screw terminal blocks for onboard I/Os



Type	Description
440549160	Plug-in screw terminal block, 10-pin, labelling 0... 9
440549170	Plug-in screw terminal block, 10-pin, labelling 10...19
440549180	Plug-in screw terminal block, 10-pole, labelling 20...29
440549190	Plug-in screw terminal block, 10-pole, labelling 30...39

Plug-in screw terminal blocks and connectors for Saia PCD2 I/O modules



Type	Description
440548470	Plug-in screw terminal block, 10-pin (type L) for wires up to 1.5 mm ² , labelling 0...9
440550480	Plug-in spring terminal block 2 × 5-pin (type K) for wires up to 1.0 mm ² , orange
440550540	Plug-in spring terminal block 2 × 5-pin (type KB) for wires up to 1.0 mm ² , black

I/O bus connection



Type	Description
PCD2.K010	I/O bus connector
PCD2.K106	I/O bus extension cable

Battery



Type	Description
463948980	Battery carrier module for PCD2. M4x60
450748170	Lithium battery for PCD2.M5540

System cables for digital modules with 16 I/Os¹⁾

PCD2.K221	Sheathed, round cable with 32 strands, each 0.25 mm ² , 1.5 m long, PCD side: 34-pin ribbon connector type D, process side: strand ends free, colour coded
PCD2.K223	Sheathed, round cable with 32 strands, each 0.25 mm ² , 3.0 m long, PCD side: 34-pin ribbon connector type D, process side: strand ends free, colour coded

System cables for adapters PCD2.K520/...K521/...K525¹⁾

PCD2.K231	Sheathed, half-round cable with 34 strands, each 0.09 mm ² , 1.0 m long, with 34-pin ribbon connector type D at both ends
PCD2.K232	Sheathed, half-round cable with 34 strands, each 0.09 mm ² , 2.0 m long, with 34-pin ribbon connector type D at both ends

System cables for 2 relay interfaces PCD2.K551/K552¹⁾

PCD2.K241	Sheathed, half-round cable with 34 strands, each 0.09 mm ² , 1.0 m long, PCD side 34-pin ribbon connector type D, process side: two 16-pin ribbon connectors
PCD2.K242	Sheathed, half-round cable with 34 strands, each 0.09 mm ² , 2.0 m long, PCD side 34-pin ribbon connector type D, process side: two 16-pin ribbon connectors

"Ribbon connector ↔ screw terminal" adapters

PCD2.K520	for 16 inputs/outputs, with 20 screw terminals, without LED
PCD2.K521	for 16 inputs/outputs, with 20 screw terminals and LED (for source operation only)
PCD2.K525	for 16 inputs/outputs, with 3 × 16 screw terminals and LED (for source operation only)
PCD2.K551	Relay interface for 8 PCD transistor outputs with 24 screw terminals and LED
PCD2.K552	Relay interface for 8 PCD transistor outputs with 24 screw terminals, LED and manual control mode (switch on-off-auto) and 1 output as feedback for the manual control mode



¹⁾For details, see Chapter 5.10

1.5 PCD1 – modular, expandable, compact CPU

The Saia PCD1 systems are the smallest programmable Saia PCD controllers in a flat design. Along with the standard communication interfaces, integrated data memory and web/IT functionality, all controllers also have at least 18 integrated I/Os. The PCD1 controllers are ideally suited to small-scale automation tasks, whose challenges and tasks can be successfully processed by the powerful CPU.

The many communication options are another advantage: Ethernet TCP/IP, USB port, the onboard RS-485 interface and the expansion options with BACnet®, for instance, are a small sample of the performance capability of PCD1.

1.5.1 Saia PCD1.M2 series

Saia PCD1.M2xxx are compact and may be expanded via modules.

Types

- ▶ PCD1.M2160 with Ethernet TCP/IP and expanded memory
- ▶ PCD1.M2120 with Ethernet TCP/IP

18 integrated I/Os
2 free I/O slots



Page 60

1.5.2 Saia PCD1.Room (PCD1.M2110R1)

Saia PCD1.Room is for applications in the field of room automation and HeaVAC.

Type

- ▶ PCD1.M2110R1 with Ethernet TCP/IP for room automation applications

24 integrated I/Os
1 free I/O slot



64

Saia PCD E-Controller (PCD1.M0160E0)

The E-controller in compact design includes in the default delivery condition S-Monitoring (energy)-functionalities, which can be customized with Saia PG5

Type: PCD1.M0160E0 with S-Monitoring function

- ▶ 18 integrated E/As
- ▶ no free I/O slots



132

Saia PCD1.M2220-C15

The E-Line control is ideally suited by the compact design for installation in an electrical sub-distribution. It can be used for example for the other E-Line modules as zoning / master station.

Type: PCD1.M2220-C15 E-Line CPU with Ethernet, 512kB

- ▶ integrated I/Os (4 DI, 2 AI, 1 WD)
- ▶ two free I/O Slots
- ▶ a variety of communication options



72

1.5.1 Saia PCD1.M2xxx controller

The Saia PCD1.M2xxx series is a compact controller with onboard I/Os and in addition two free I/O slots for plug-in or communication interface modules. The Web/IT functionality, the onboard memory, the range of standard communication interfaces and the expansion options offer ideal solutions for small to medium systems.



Device design

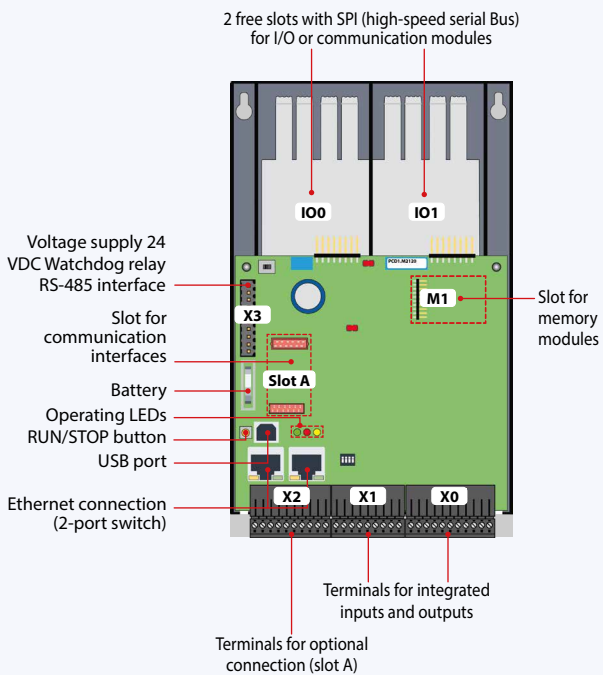

System properties

- ▶ Up to 50 inputs/outputs
May be expanded remotely with RIO PCD3.T66x
- ▶ Up to 8 communication interfaces
- ▶ USB and Ethernet interface onboard
- ▶ Large onboard memory for programs (up to 1 MB) and data (up to 128 MB file system)
- ▶ Automation Server for integration into Web/IT systems



Types

- ▶ PCD1.M2160 with Ethernet TCP/IP and expanded memory
- ▶ PCD1.M2120 with Ethernet TCP/IP

Mounting

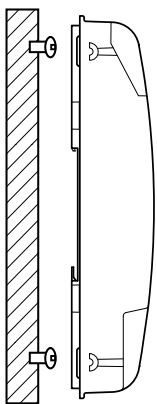

on a level surface

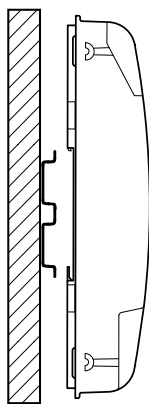

on two DIN rails
(2 × 35 mm)
in accordance with
DIN EN 60715 TH35)

Dimensions

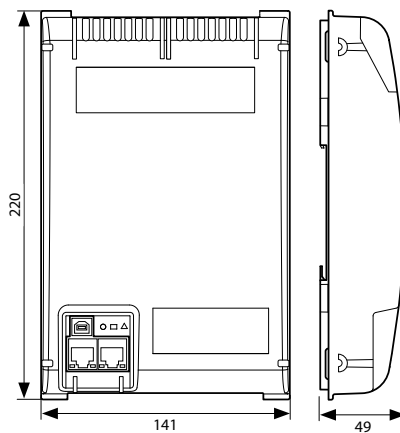

Compact mass:
140.8 × 220 × 49 mm

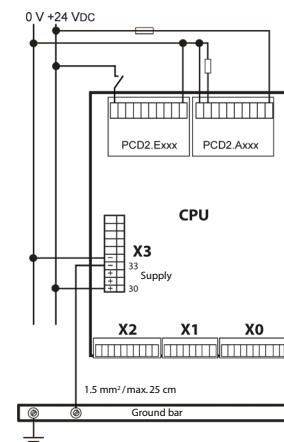

Power supply and connection concept



Additional information is provided in the Chapter Saia PCD3 power supply and connection concept, and in the Manual 26-875.

Overview Saia PCD1.M2xxx

Technical data

Memory and file system	Types:		
		PCD1.M2160	PCD1.M2120
Program memory, DB/Text (Flash)		1 MB	512 kByte
User memory, DB/Text (RAM)		1 MB	128 kByte
Onboard user flash file system		128 MB	8 MB
Integrated communication			
Ethernet connection (2-port switch) 10/100 Mbit/s, full-duplex, auto-sensing, auto-crossing		Yes	Yes
USB port USB 1.1 device 12 Mbit/s		Yes	Yes
RS-485 (terminal X3), up to 115 kbit/s		Yes	Yes

General specifications

Operating voltage	24 VDC, -20/+25 % max. inkl. 5% ripple (in accordance with EN/IEC 61131-2)
Battery for data backup (replaceable)	Lithium battery with a service life of 1 to 3 years
Operating temperature:	0...55 °C
Dimensions (W × H × D)	142 × 226 × 49 mm
Mounting location	2× DIN rails in accordance with DIN EN60715 TH35 (2 × 35 mm) or on a flat surface
Protection type	IP 20
Capacity 5 V/+V (24 V) internal	max. 500 mA/200 mA
Power consumption	typically 12 W

Onboard inputs/outputs

Inputs:

6 Digital inputs (4 + 2 interrupts)	15...30 VDC, 3 ms input filter (0.2 ms for the interrupts)	Terminal X1
2 Analogue inputs, selectable via DIP switch	-10...+10 VDC, 0...±20 mA, Pt1000, Ni1000, Ni1000 L&S, 0...2.5 kΩ, 12 bit resolution	Terminal X1

Outputs:

4 Digital outputs	24 VDC / 0.5 A	Terminal X0
1 PWM output	24 VDC / 0.2 A	Terminal X0

selectable/configurable via PG5

4 Digital inputs or outputs	24 VDC / data as digital inputs or outputs	Terminal X0
1 Watchdog relay or make contact	48 VAC or VDC, 1 A With DC switching voltage a free-wheeling diode should be connected in parallel to the load	Terminal X3

Analogue output module Saia PCD7.W600

This module has 4 analogue outputs 0 to +10 V with a 12-bit resolution and has been specifically developed for the new PCD1 CPUs (PCD1.M2xxx, PCD1.M0160E0, PCD1.M2110R1). It can be plugged into slot A of the PCD1 CPU like the PCD7.F1xxS communication module.



Plug-in I/O modules for slots I/O 0 and I/O 1

The modules listed in the PCD2.M5 series (Chapter 1.4) are also used for the Saia PCD1 series.

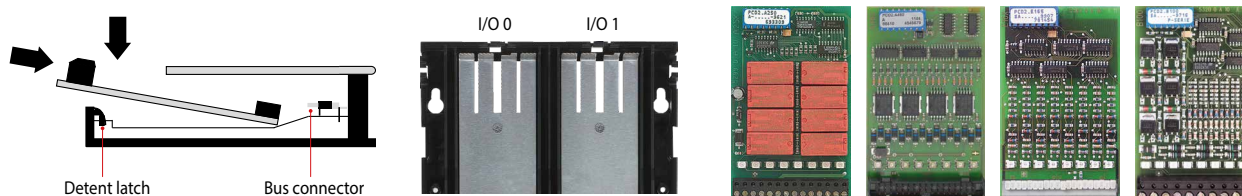

Saia PCD1.M2xxx interface options

In addition to the onboard interfaces, the interface functions can also be expanded in a modular way using the various slots. Numerous protocols are therefore supported by the Saia PCD1.M2 series. Detailed information and an overview is contained in the Chapter BA communication systems.

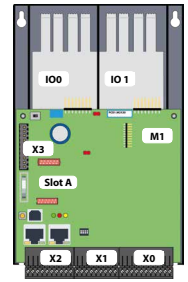

Communication		Electrical isolation	Internal current consumption 5V +V (24 V)		Slot	I/O connector type ¹⁾
PCD7.F110S	RS-485/RS-422	---	40 mA	-	Slot A	
PCD7.F121S	RS-232 with RTC/CTS, DTR/DSR, DCD suitable for modem, EIB connection	---	15 mA	-	Slot A	
PCD7.F150S	RS-485 with termination resistors that can be activated	●	130 mA	-	Slot A	
PCD7.F180S	Belimo MP-Bus, for connecting up to 8 drives on one line	---	15 mA	15 mA	Slot A	
PCD2.F2100	RS-422/RS-485 plus PCD7.F1xxS as option	---	110 mA	-	IO 0/1	2x K
PCD2.F2150	BACnet® MS/TP RS-485 plus PCD7.F1xxS as an option	---	110 mA	-	IO 0/1	2x K
PCD2.F2210	RS-232 plus PCD7.F1xxS as an option	---	90 Ma	-	IO 0/1	2x K
PCD2.F2610	DALI Master for up to 64 DALI devices	---	90 Ma	-	IO 0/1	L
PCD2.F27x0	M-Bus master with 2 M-Bus interfaces	---	70 mA	8 mA	IO 0/1	L
PCD2.F2810	Belimo MP-Bus plus PCD7.F1xxS as an option	---	90 Ma	15 mA	IO 0/1	2x K

¹⁾ Plug-in I/O terminal blocks are included with I/O modules. Spare terminals, ribbon connectors with system cables and separate terminals are ordered as accessories.



System properties of PCD2.F2xxx modules

The following points must be noted when using the PCD2.F2xxx interface modules:

- ▶ Max. 2 modules PCD2.F2xxx (4 interfaces) can be used in slots I/O 0/1 per PCD1.M2 system.
- ▶ Consult the information and examples provided in the Manual 26-875 for PCD1.M2 to determine the maximum communication capacity for each PCD1.M2 system.

Memory modules

The onboard memory of the Saia PCD1.M2xxx can be expanded using a Saia PCD7.Rxxx module in slot M1. In addition, the Saia PCD1.M21x0 can be expanded with BACnet® IP.

Additional information about the memory management and structure is contained in the Chapter Saia PCD System Description.

Memory expansion and communication		
PCD7.R562	Flash memory module for BACnet® firmware with 128 MB file system	M1
PCD7.R610	Basic module for Micro SD flash card	M1
PCD7.R-MSD1024	Micro SD flash card 1024 MB, PCD formatted	PCD7.R610



PCD7.R562



PCD7.R610

Accessories and consumables for Saia PCD1.M2xxx

Labelling

The self-adhesive labels can be printed direct with the SBC LabelEditor from the PG5 Device Configurator

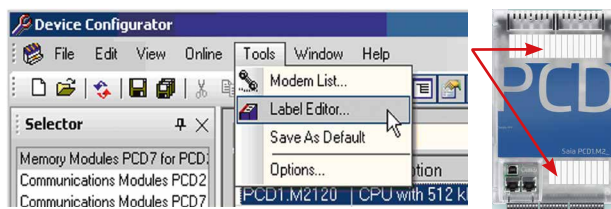

EPLAN macros

EPLAN macros are available for project planning and engineering.



The EPLAN® electric P8 macros are available on the support site. The macros and article data are also provided on the EPLAN® data portal.



Battery for data backup

Type	Description
450748170	Lithium battery for PCD processor unit (RENATA button battery type CR 2032)



Plug-in screw terminal block

440550890	Plug-in screw terminal block, 11-pin, labelling 0...10	Terminal X0
440550870	Plug-in screw terminal block, 9-pin, labelling 11...19	Terminal X1
440550880	Plug-in screw terminal block, 10-pin, labelling 20...29	Terminal X2
440549190	Plug-in screw terminal block, 10-pin, labelling 30...39	Terminal X3



Range of uses

- ▶ For small and medium systems
- ▶ Modernisation and expansion of existing systems through, for example, the compact construction
- ▶ Versatile interface options, including to existing systems as a gateway, for example: optimisation of a cooling system by setting all the free parameters



Connection to an existing EIB/KNX installation providing conference rooms with a web connection



Use as communication interface with M-Bus in a district heating network

1.5.2 Saia PCD1.Room (PCD1.M2110R1)

Saia PCD1.Room (PCD1.M2110R1) is a programmable room controller for complex solutions with many communication options. In addition to the I/Os that are already integrated, the controller has a free I/O slot for individual expansion with inputs/outputs or communication options. Web/IT functions for mobile operation, for instance, are also already onboard. Furthermore, Saia PCD1.Room offers various possibilities for integrating other systems in the room using standard communication interfaces. (Energy) efficient and individual room automation can be easily implemented as a result. The controller also provides a good basis for achieving the energy efficiency classes in accordance with EN 15232:2012.



Device design with connection example

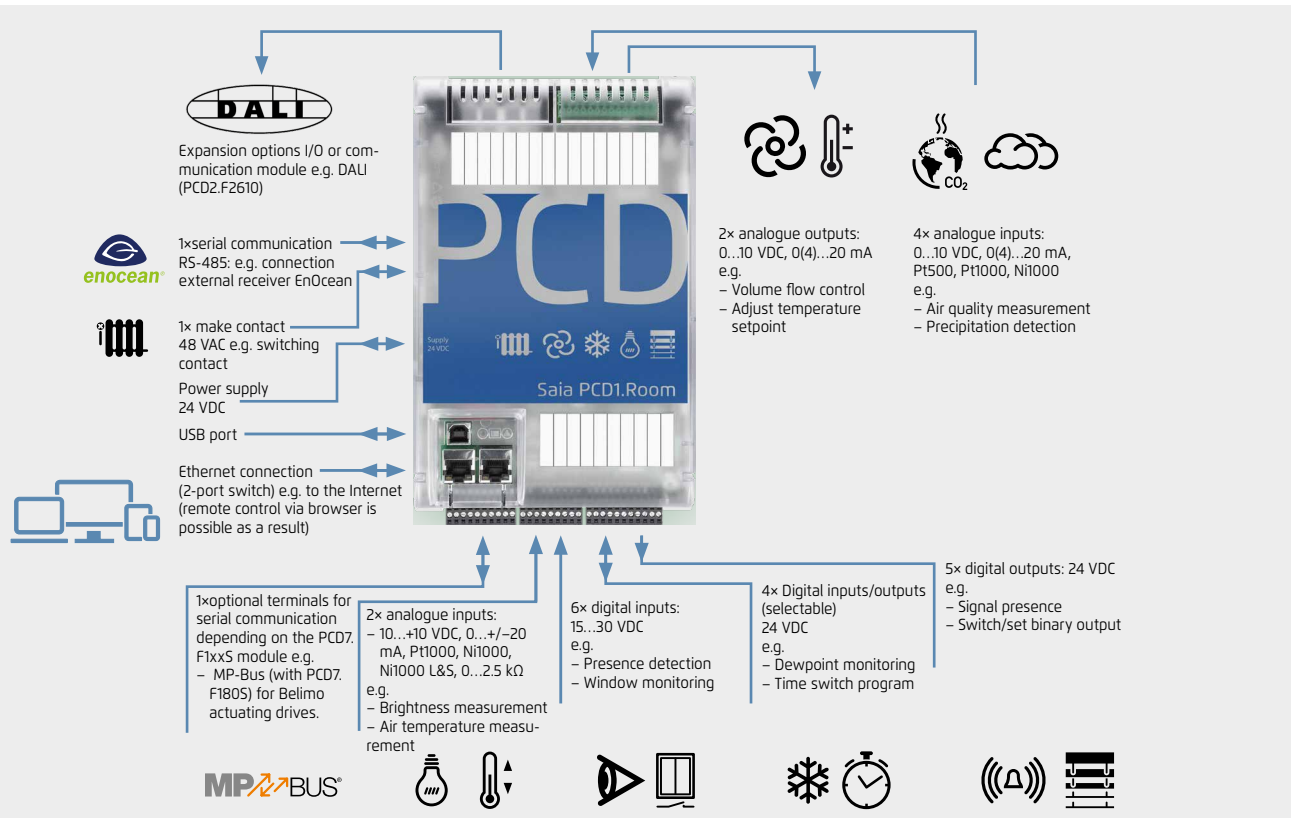

Lighting, sun protection and individual room regulation can be optimally coordinated with one another with this controller. This example showing possible assignments was compiled based on applications in accordance with the VDI 3813 list of room automation functions and the DIN EN 15232 list of building automation functions.



The Smart RIO Manager function is not supported!

Mounting

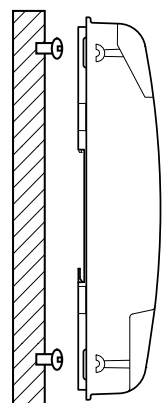

on a level surface

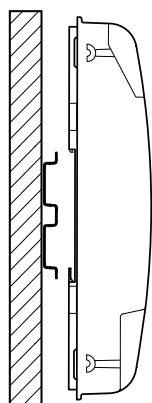

on two DIN rails
(2 x 35 mm in accordance with DIN EN 60715 TH35)

Dimensions

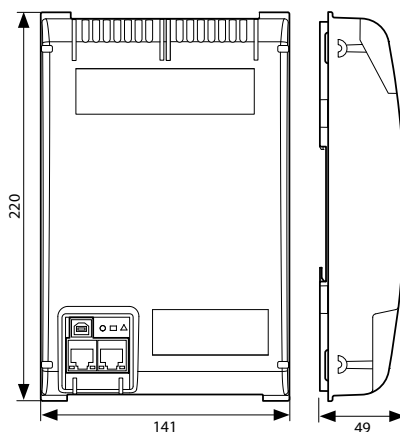

Compact mass:
140.8 x 220 x 49 mm

Power supply and connection concept

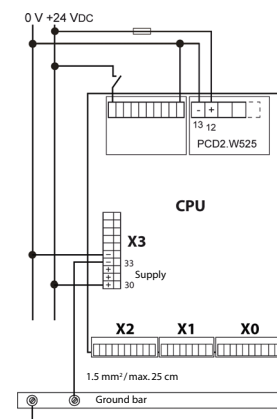

Further information is provided in the Chapter Saia PCD3 power supply and connection concept, and in the Manual 26-875.

Overview of Saia PCD1.Room (PCD1.M2110R1)

Technical data

Memory and file system	Type:	PCD1.M2110R1
Program memory, DB/text (Flash)		256 kByte
User memory, DB/text (RAM)		128 kByte
Onboard user flash file system		8 MB
Integrated communication		
Ethernet connection (2-port switch) – 10/100 Mbit/s, full-duplex, auto-sensing, auto-crossing		yes
USB port – USB 1.1 device 12 Mbit/s		yes
RS-485 – (terminal X3), up to 115 kbit/s		yes

General specifications

Operating voltage	24 VDC, –20/+25 % max. inkl. 5% ripple (in accordance with EN/IEC 61131-2)
Battery for data backup (replaceable)	Lithium battery with a service life of 1 to 3 years
Operating temperature:	0...55°C
Dimensions (W × H × D)	142 × 226 × 49 mm
Mounting location	2× DIN rails in accordance with DIN EN60715 TH35 (2 × 35 mm) or on a smooth surface
Protection type	IP 20
Capacity 5 V/+V (24 V) internal	max. 500 mA/200 mA
Power consumption	typically 12 W
Automation Server	Flash memory, file system, FTP and web server, email, SNMP



Onboard inputs/outputs

Inputs:

6 Digital inputs (4 + 2 interrupts)	15...30 VDC, 3 ms / 0.2 ms input filter	Terminal X1
2 Analogue inputs, selectable via DIP switch	–10...+10 VDC, 0...±20 mA, Pt1000, Ni1000, Ni1000 L&S, 0...2.5 kΩ, 12 bit resolution	Terminal X1
4 Analogue inputs, selectable via DIP switch	0...10 VDC, 0(4)...20 mA, Pt1000, Pt 500, Ni1000, 14 bit resolution	IO 1

Outputs:

4 Digital outputs	24 VDC / 0.5 A	Terminal X0
1 PWM output	24 VDC / 0.2 A	Terminal X0
2 Analogue outputs, selectable via PG5	0...10 VDC or 0(4)...20 mA, 12 bit resolution	IO 1

selectable/configurable via PG5

4 Digital inputs or outputs	24 VDC / data as digital inputs or digital outputs	Terminal X0
1 Watchdog relay or as make contact	48 VAC or VDC, 1 A With DC switching voltage a free-wheeling diode should be connected in parallel to the load	Terminal X3

Analogue output module Saia PCD7.W600

This module has 4 analogue outputs 0 to +10 V with a 12-bit resolution and has been developed specifically for use with the new PCD1 CPUs (PCD1.M2xx0, PCD1.M0160E0, PCD1.M2110R1). It can be plugged into slot A of the PCD1 CPU like the PCD7.F1xxS communication module.



Plug-in I/O modules for slot I/O 0

The modules listed in the PCD2.M5 series (Chapter 1.4) are also used for the Saia PCD1 series.



! Only a PCD2.W525 module that is already supplied with the controller in the default setup functions in slot I/O 1. If the module is removed, the controller will go to Stop!

Saia PCD1.Room (PCD1.M2110R1) interface options

In addition to the onboard interfaces, the interface functions can also be expanded in a modular way using the various slots. Numerous protocols are therefore supported by the Saia PCD1.M2110R1. A detailed list of all the protocols can be found in the Chapter BA communication systems.

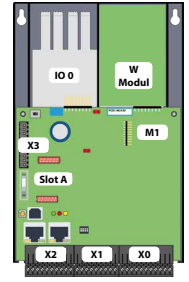

Communication		Electrical isolation	Internal current consumption 5V +V (24 V)		Slot	I/O connector type ¹⁾
PCD7.F110S	RS-422 avec RTS/CTS ou RS-485 ²⁾	---	40 mA	–	Slot A	
PCD7.F121S	RS-232 with RTC/CTS, DTR/DSR, DCD, suitable for modem or EIB connection	---	15 mA	–	Slot A	
PCD7.F150S	RS-485 ²⁾	•	130 mA	–	Slot A	
PCD7.F180S	Belimo MP-Bus, for connecting up to 8 drives on one line	---	15 mA	15 mA	Slot A	
PCD2.F2100	RS-422/RS-485 ²⁾ , plus PCD7.F1xxS en option	---	110 mA	–	IO 0/1	2× K
PCD2.F2150	BACnet® MS/TP RS-485 plus PCD7.F1xxS as an option	---	110 mA	–	IO 0/1	2× K
PCD2.F2210	RS-232 plus PCD7.F1xxS as an option	---	90 Ma	–	IO 0/1	2× K
PCD2.F2610	DALI master for up to 64 DALI devices	---	90 Ma	–	IO 0/1	L
PCD2.F27x0	M-Bus master with 2 M-Bus interfaces	---	70 mA	8 mA	IO 0/1	L
PCD2.F2810	Belimo MP-Bus plus PCD7.F1xxS as an option	---	90 Ma	15 mA	IO 0/1	2× K

¹⁾ Plug-in I/O terminal blocks are supplied with I/O modules.
Spare terminals, ribbon connectors with system cables and separate terminals are ordered as accessories.

²⁾ with line termination resistors that can be activated.



System properties of PCD2.F2xxx modules

The following points must be noted when using the PCD2.F2xxx interface modules:

- ▶ Per PCD1.M2110R1 Room Edition a max. of 1 module PCD2.F2xxx (2 interfaces) can be used with slot I/O0.
- ▶ Consult the information and examples provided in the Manual 27-619 for PCD1.M2110R1 to determine the maximum communication capacity for each PCD1.M2 system.

Memory modules

The onboard memory can be expanded using a PCD7.Rxxx module in slot M1. In addition, BACnet® IP can be activated. Additional information about the memory management and structure is contained in the Chapter Saia PCD System description.

Memory expansion and communication		
PCD7.R562	Flash memory module for BACnet® firmware with 128 MB file system	M1
PCD7.R610	Basic module for Micro SD flash card	M1
PCD7.R-MSD1024	Micro SD flash card 1024 MB, PCD formatted	PCD7.R610



PCD7.R562



PCD7.R610

Accessories and consumables for Saia PCD1.Room (PCD1.M2110R1)

Labelling

The self-adhesive labels can be printed direct with the SBC LabelEditor from the PG5 Device Configurator

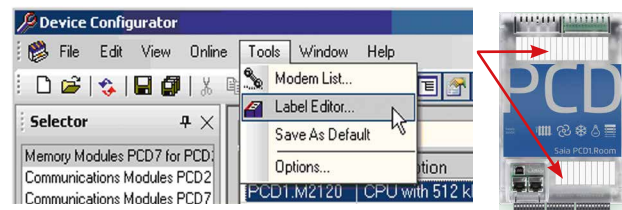

EPLAN macros

EPLAN macros are available for project planning and engineering



The EPLAN® electric P8 macros are available on the support site.

The macros and article data are also provided on the EPLAN® data portal.



Battery for data backup

Type	Description
4405748170	Lithium battery for PCD processor unit (RENATA button battery type CR 2032)



Plug-in screw terminal block

440550890	Plug-in screw terminal block, 11-pin, labelling 0...10	Terminal X0
440550870	Plug-in screw terminal block, 9-pin, labelling 11...19	Terminal X1
440550880	Plug-in screw terminal block, 10-pin, labelling 20...29	Terminal X2



Range of uses:

Applications



Options for programmable applications:



- ▶ Radiators
- ▶ Fan coil applications
- ▶ Cooling ceiling
- ▶ VAV – variable air volume
- ▶ Air quality control
- ▶ Signal contacts (occupancy control, presence detection, window monitoring)
- ▶ Lighting control
- ▶ Blind control
- ▶ etc.



Room control units



Connection options via the following:

- ▶ Analogue signals (onboard)
- ▶ S-Bus (onboard)
- ▶ Modbus (onboard)
- ▶ Internet access, web server (onboard)
- ▶ BACnet® with PCD7.R562 (slot M1)
- ▶ BACnet® MS/TP with PCD2.F2150 (slot I/O 0)
- ▶ KNX over IP (IP onboard)
- ▶ KNX TP with an external coupler
- ▶ EnOcean with external receiver.

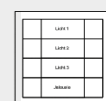

Applications must take the exact number of I/Os into account. Coupling relays (e.g.: PCD7.L252) or EI-Line-RIO (S-Bus) required. The S-Bus stations are limited to a maximum of 10 units per PCD1.Room. The same applies to Modbus stations (total of 10 units).

1.6 PCD1 E-Line

Compact design for electrical distributors



Overview of Saia PCD E-Line device series

1.6.1 PCD1 E-Line system overview

Description of the basic structure and system of the PCD1 E-Line series

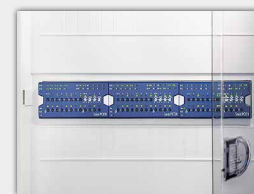

Page 70

1.6.2 PCD1 controller for E-Line

The E-Controller for installation in electrical distributors is the ideal controller as a master and Ethernet interface for the Saia PCD1 E-Line

- ▶ PCD1.M2220-C15
- ▶ additional Saia PCD controllers



72

1.6.3 PCD1 E-Line full programmable modules

Programmable modules for specific applications

- ▶ PCD1.G1100-C15 Light and shade module
- ▶ PCD1.F2611-C15 DALI module and add. RS-485
- ▶ PCD1.W5300-C15 Analogue module



75

1.6.4 PCD1 E-Line input and output modules

I/O modules with override operating level

- ▶ S-Series
- ▶ L-Series



80

1.6.5 E-Line system components

Extension of the communication options

- ▶ Power supplies



83

1.6.1 PCD1 E-Line system overview

The Saia PCD1 E-Line series was specifically developed for installation in electrical sub-distributors. The compact design enables automation in confined spaces. The two-wire bus connection between individual modules enables both centralised and decentralised automation over a distance of up to 1000 m. The modules are designed and produced in accordance with IEC 61131-2 to industrial quality. The extensive programmability and integration of Web+IT technologies enables effective automation over the entire service life of plants and properties.



Control system

Visualisation and control of the connected components is an important aspect of automation. The web server can directly undertake the tasks of the control system for this purpose for small applications. For more complex projects, data is transferred to a control system via standard communication protocols such as BACnet. The Saia PCD® Supervisor control system is suitable for this.

Ethernet

RS-485

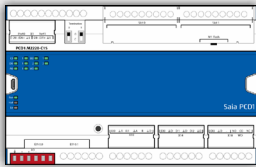

Controller

The Saia PCD controller functions as a master for the attached modules. Here it can undertake more complex controls and form the interface to the control level. The integrated automation server and the Web+IT functions can be directly used here to visualise the control via a web panel or browser. Saia PCD is the ideal interface for other plants thanks to the support of numerous protocols such as BACnet, Modbus, etc.



Programmable I/O modules

The programmable I/O modules of the Saia PCD1 E-Line series with Saia PG5® enable the autonomous and safe operation of the modules even if communication to the master station is interrupted.

The local function of a room, for example, is therefore guaranteed at any time. The modules are programmed with Saia PG5® via the master controller or directly via USB.

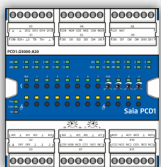

I/O modules

The PCD1 E-Line I/O modules enable centralised automation in the control cabinet and the decentralised distribution of the components through the bus connection. They can be commissioned quickly using the implemented override operation.



System Accessories

Power supplies are offered as a supplement for installation in the electrical distribution.

General properties of the Saia PCD1 E-Line modules

Mounting in the sub-distributor

The E-Line design enables the modules to be mounted in standard electrical sub-distributors. This significantly reduces the complexity of the mounting compared to automation control cabinets.

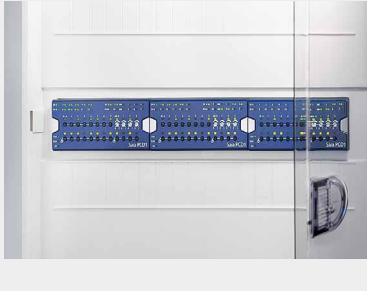

Mounting

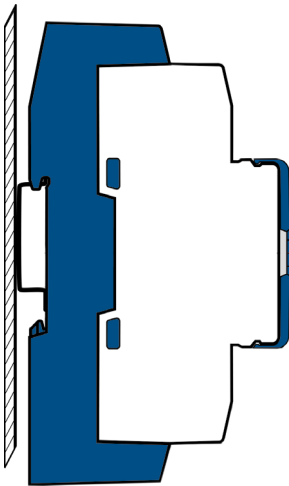

on DIN rails 35 mm
(in accordance with DIN EN 60715) TH35

Bus topology

Communication with the S-Bus protocol is optimised for speed and creates a reliable connection up to 1000 m. The modules can be used as local or remote modules.

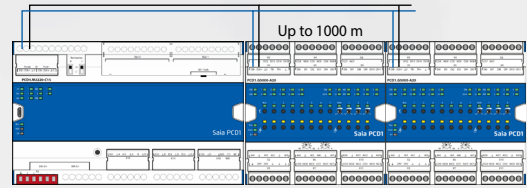

Bus wiring

DB- and /DA+ terminals must be used for exchanging data between the modules. The bus is through-wired to a terminal to ensure the exchange between modules to avoid an interruption in the bus connection.

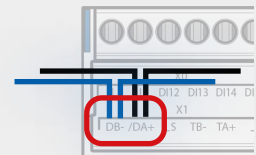

! Flexible cables with a cross section of no more than 0.75 mm² are permissible for bus wiring. 1.5 mm² on maximum applies for the overall terminal.

Product number key (ASN key)

Some main features of the E-Line modules can be identified immediately using the product number key. For example, if a module is fully programmable (5 at the end) or suitable for RIO mode (a 0).

Example:

PCD1.Gxxxx-C15

- 0: not programmable
- 5: programmable
- 1: with LED for I/O
- 2: with LED and man. override op.
- 3: with LED and display
- A: 24 VDC
- C: 24 VDC/VAC
- F: 230 VAC
- J: 110...230 VAC

Dimensions

Compatible with electrical control cabinets (in accordance with DIN 43880, size 2 x 55 mm)

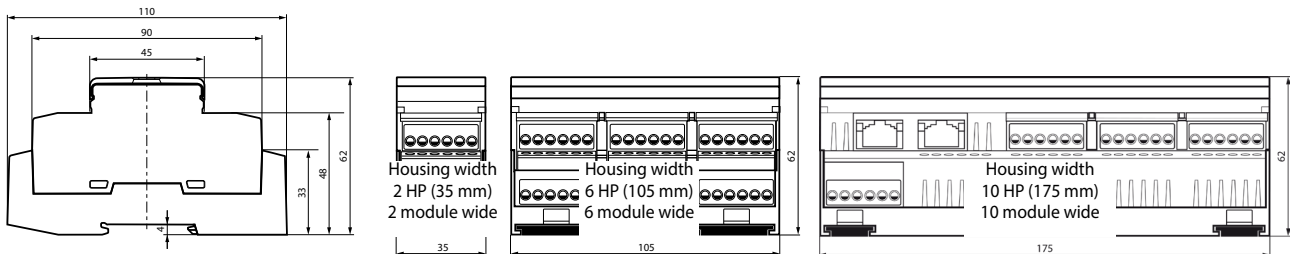

Accessories and consumables*

EPLAN macros

EPLAN macros are available for project planning and engineering

The EPLAN® electric P8 macros are available on the support site.

The macros and article data are also provided on the EPLAN® data portal.



*In preparation

1.6.2 PCD1 E-Line controller

The Saia PCD1 E-Line CPU series was specifically developed for installation in electrical sub-distributors. The compact design enables automation in confined spaces. The E-Line CPU is designed and produced to industrial quality in accordance with IEC 61131-2. The extensive programmability and integration of web+IT technologies enables effective automation over the entire service life of plants and properties. The Saia PCD E-Line CPU is the ideal interface for other plants owing to the support of numerous protocols such as BACnet, Modbus, etc. It is also ideal to achieve (energy-) efficient and individual room automation. It also provides a good basis to achieve the energy efficiency classes in accordance with EN 15232:2012.



Device design

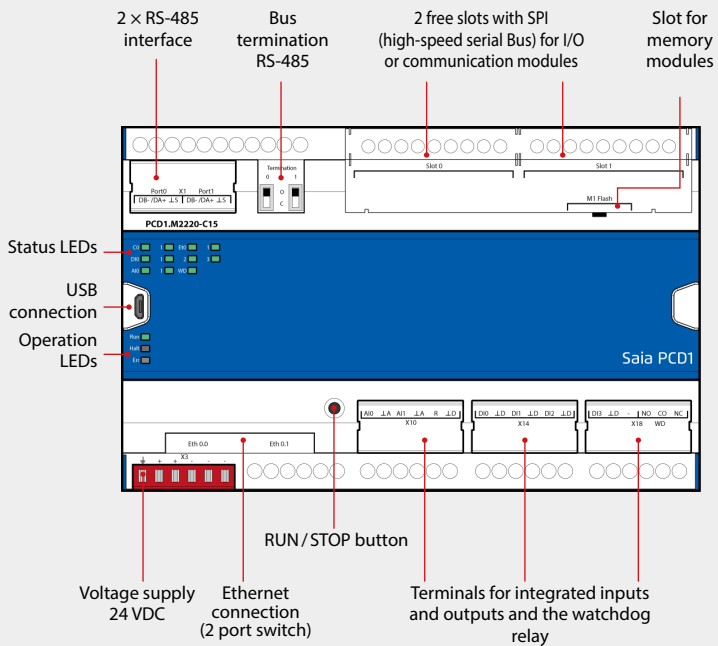

Features

- ▶ 4 digital inputs
- ▶ 2 analogue inputs, individually configurable via software
- ▶ 1 Watchdog relay/changeover contact
- ▶ Electrical isolation between supply, bus and I/Os
- ▶ Pluggable terminal blocks protected by flaps
- ▶ Status LEDs on the front
- ▶ Ethernet switch, 2 x RS-485 and USB interface
- ▶ Large onboard memory for data (up to 128 MByte file system)
- ▶ Automation server for integration in web+IT systems
- ▶ Freely programmable with Saia PG5®
- ▶ FRAM technology



Dimensions and installation

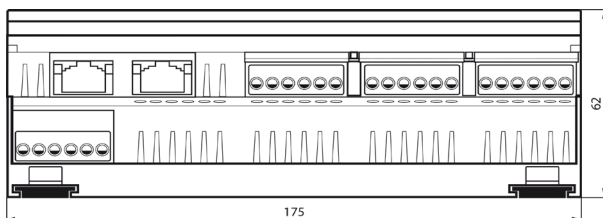
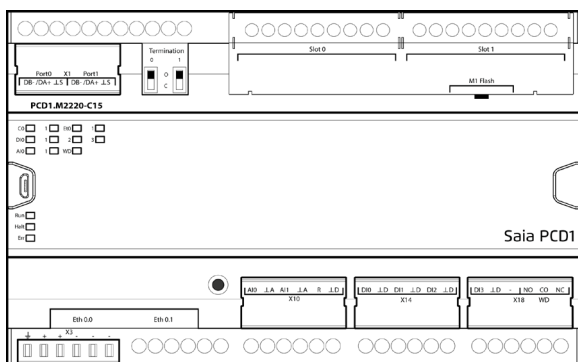

Housing width 10 HP (175 mm)
Compatible with electrical control cabinets
(in accordance with DIN 43880, size 2 x 55 mm)

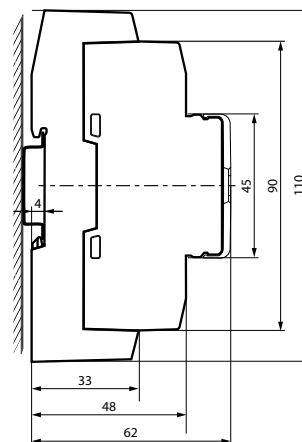

on DIN rails 35 mm
(in accordance with DIN EN 60715 TH35)

Connection concept

The device is supplied by a 24 VDC or AC voltage supply.

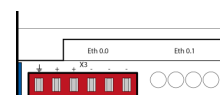

Overview Saia PCD1.M2220-C15



PCD1.M2220-C15

Technical data

Memory and file system

Program memory, DB/Text (Flash)	512 kByte
User memory, DB/Text (RAM)	128 kByte
Onboard user flash file system	128 MB

Integrated communication

Ethernet connection (2-port switch)	Yes
10/100 Mbit/s, full-duplex, auto-sensing, auto-crossing	Yes
Service interface: Micro USB	Yes
RS-485, up to 115 kbit/s	Yes

General specifications

Operating voltage	Nominal 24 VAC (50 Hz) or DC, 24 VDC, $-20/+25\%$ incl. 5% ripple, 24 VAC, $-15\%/+15\%$ (in accordance with EN/IEC 61131-2)
Operating temperature:	0...55°C
Dimensions (W × H × D)	175 × 110 × 62 mm
Mounting location	2 × DIN rails in accordance with DIN EN60715 TH35 (2 × 35 mm) or on a flat surface
Power consumption	typically 6.5 W

Onboard inputs/outputs

Inputs		Terminal
4 Digital inputs	24 VAC / VDC source operation (positive switching) or sink operation	X14 + X18
2 Analogue inputs, selectable via "Device Configurator"	$-10...+10$ VDC, Pt1000, Ni1000, Ni1000 L&S, 0...2.5 k Ω , 0...7.5 k Ω , 0...300 k Ω (NTC10k and NTC20k), 12 bit resolution	X10
Outputs		
1 Watchdog relay or change-over contact	48 VAC or VDC, 1 A With DC switching voltage a free-wheeling diode should be connected in parallel to the load	X18

Plug-in I/O modules for slots I/O 0 and I/O 1

The modules listed in the PCD2.M4 and PCD2.M5 series (Chapter 1.4) are also used for the E-Line CPUs.

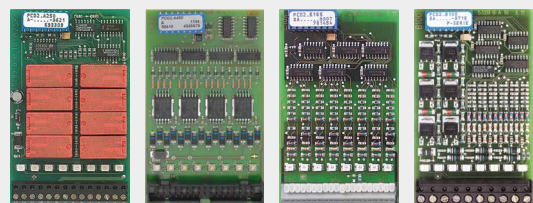
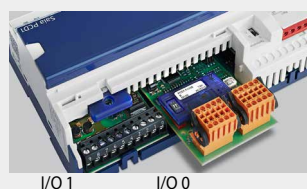
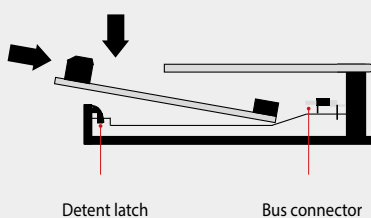

PCD1.M2220-C15 interface options

In addition to the onboard interfaces, the interface functions can also be expanded in a modular way using the various slots. Numerous protocols are therefore supported by the Saia PCD1.M2220-C15. Detailed information and an overview is contained in the Chapter BA communication systems.

Communication		Electrical isolation	Internal current consumption 5V +V (24 V)		Slot	I/O connector type ¹⁾
PCD7.F110S	RS-422 with RTS/CTS or RS-485 ²⁾	---	40 mA	-	Slot A ³⁾	
PCD7.F121S	RS-232 with RTC/CTS, DTR/DSR, DCD, suitable for modem or EIB connection	---	15 mA	-	Slot A ³⁾	
PCD7.F150S	RS-485 ²⁾	•	130 mA	-	Slot A ³⁾	
PCD7.F180S	Belimo MP-Bus, for connecting up to 8 drives on one line	---	15 mA	15 mA	Slot A ³⁾	
PCD2.F2100	RS-422/RS-485 ²⁾ , plus PCD7.F1xxS en option	---	110 mA	-	IO 0/1	2× K
PCD2.F2150	BACnet® MS/TP RS-485 plus PCD7.F1xxS as an option	---	110 mA	-	IO 0/1	2× K
PCD2.F2210	RS-232 plus PCD7.F1xxS as an option	---	90 Ma	-	IO 0/1	2× K
PCD2.F2610	DALI master for up to 64 DALI devices	---	90 Ma	-	IO 0/1	L
PCD2.F27x0	M-Bus master with 2 M-Bus interfaces	---	70 mA	8 mA	IO 0/1	L
PCD2.F2810	Belimo MP-Bus plus PCD7.F1xxS as an option	---	90 Ma	15 mA	IO 0/1	2× K

¹⁾ Plug-in I/O terminal blocks are supplied with I/O modules.

Spare terminals, ribbon connectors with system cables and separate terminals are ordered as accessories.

²⁾ with line termination resistors that can be activated.

³⁾ On slot A of the PCD2 communication cards PCD2.Fxxxx.

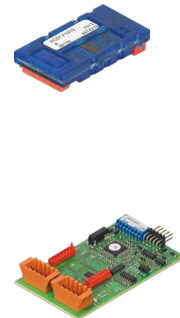

System properties of PCD2.F2xxx modules

The following points must be noted when using the PCD2.F2xxx interface modules:

- ▶ Max. 2 modules PCD2.F2xxx (4 interfaces) can be used in slots I/O 0/1 per PCD1.M2220-C15.

Memory modules

The onboard memory of the E-Line CPU can be expanded using a Saia PCD7.Rxxx module in slot M1. In addition, the controller can be expanded with BACnet® IP.

Additional information about the memory management and structure is contained in the chapter Saia PCD System Description.



PCD7.R562

Memory expansion and communication

PCD7.R562	Flash memory module for BACnet® firmware with 128 MB file system	M1
PCD7.R610	Basic module for Micro SD flash card	M1
PCD7.R-MSD1024	Micro SD flash card 1024 MB, PCD formatted	PCD7.R610



PCD7.R610

System design with PCD1 E-Line modules and Saia PCD® controllers

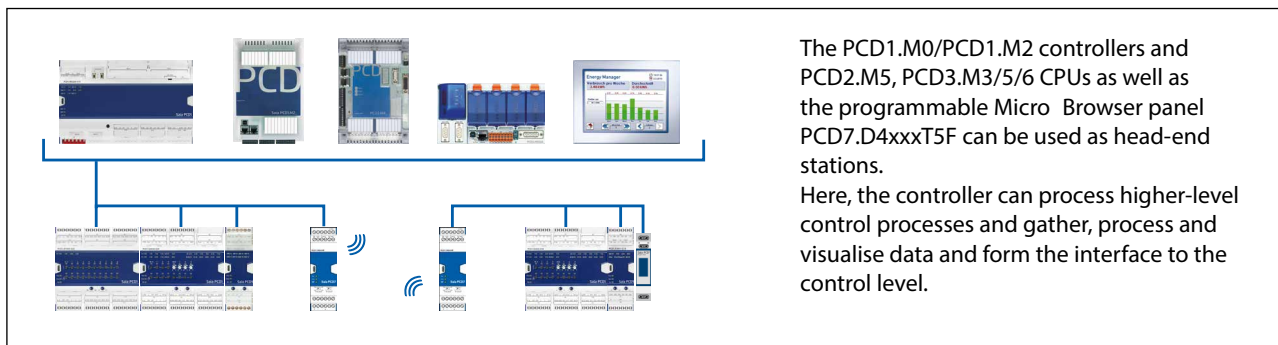

The PCD1.M0/PCD1.M2 controllers and PCD2.M5, PCD3.M3/5/6 CPUs as well as the programmable Micro Browser panel PCD7.D4xxT5F can be used as head-end stations.

Here, the controller can process higher-level control processes and gather, process and visualise data and form the interface to the control level.

1.6.3 PCD1 E-Line fully programmable modules



The Saia PCD1 E-Line fully programmable modules are for specific applications. For example for room automation, zone control and decentralised automation. The modules are freely programmed using the Saia PG5® tool. The Saia PCD1 E-Line series enables autonomous and safe operation of the modules even if communication to the master station is interrupted. The local function of a room, for example, is therefore guaranteed at any time.

System properties

- ▶ Freely programmable modules for specific applications
- ▶ Galvanic isolation between supply, bus and I/Os
- ▶ Pluggable terminal blocks protected by covers
- ▶ Status LEDs on the front
- ▶ RS-485 and USB interface
- ▶ Industrial quality
- ▶ Each wire is a connection

Connection concept

The modules are supplied with a 24 VDC or AC voltage supply. Supply to the modules is below.

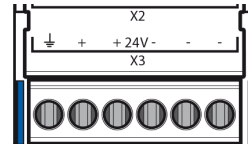

Bus topology and applications

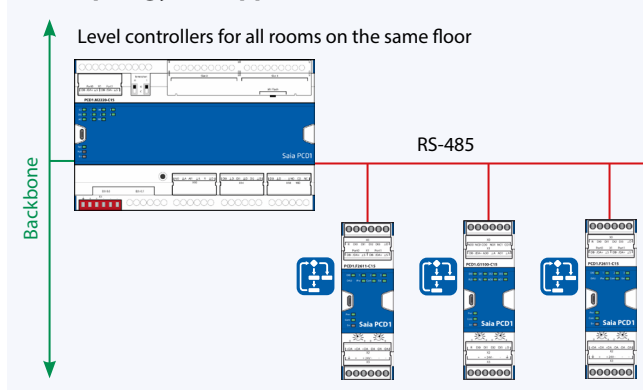

All the modules are freely programmable and can be operated as "standalone". Data is exchanged between them via the RS-485 connection and a terminal, e.g. a level controller.

Thanks to the options with the autonomous functions, the modules are ideally suitable for:

- ▶ Room automation
- ▶ Zone control
- ▶ Decentralised automation

LED

The currently active statuses are displayed on the respective LEDs for the inputs and outputs. The same applies to the voltage supply, communication and errors.

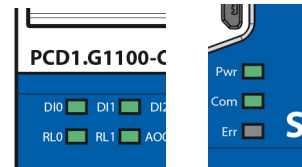

Configuration via USB interface



E-Line Configuration App

This app can be used to configure the communication protocol on the RS-485 of the E-Line RIO's, the baud rate, parity and stop bits as well as the station number of the E-Line RIO.

S-Bus or Modbus can be selected as the serial communication protocol. The modules are delivered from the factory with S-Bus.

If the rotary switches are set to position 99, the station number can be defined by the device configuration in a range of 0 ... 253.

The E-Line app can be operated on PCs with Windows 7 and Windows 10 operating systems.

A USB connection between the PC and the E-Line RIO is required.



! The installation programme can be downloaded from the SBC Support page: www.sbc-support ▶ E-Line RIO I/O modules.

Programming

The modules are programmed with Saia PG5® via a master controller or directly via Micro-USB. This enables additional options for commissioning and during operation.

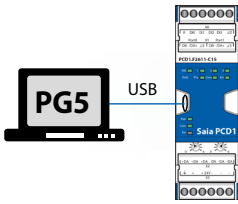

Programming direct via USB

E-Line modules have a Micro-USB connection at the front of the module. For example, the user program for the related module or a firmware update for the module can be loaded via the direct connection of the PC to the module via USB.

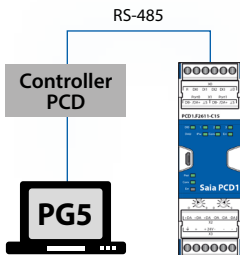

Programming via a master controller (PCDx.Mxxxx)

The master controller connected to the freely programmable E-Line modules uses the RS-485 bus (S-Bus), to load the user program or a firmware update on the corresponding modules.

Here the master controller is used as a gateway.

The modules are programmed with Saia PG5® using FBoxes or IL. A range of FBoxes is therefore available to simplify engineering.

List of libraries that are supported:

PG5 standard FBox libraries

- ▶ Binary
- ▶ Blinker
- ▶ Block Control (no SB)
- ▶ Buffers
- ▶ Com.Text (not interpreted)
- ▶ Converter
- ▶ Counter
- ▶ DALI E-Line Driver (new)
- ▶ Data Block
- ▶ Data Buffer
- ▶ EIB Driver (partly)
- ▶ EnOcean (partly)
- ▶ Flip-Flop
- ▶ Floating Point (IEEE only)
- ▶ HVC (partly)
- ▶ Indirect
- ▶ Integer
- ▶ Ladder
- ▶ Move In/Out
- ▶ Modbus (E-Suite)
- ▶ Regulation (partly)
- ▶ Special, sys Info (partly)
- ▶ Timer
- ▶ PHC

In addition to these libraries, a new “E-Suite V2” library is available for specific applications that can be created with the Saia PCD1 E-Line modules.

An example for the electrical plant: Shade control, light dimming...

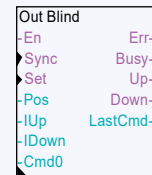
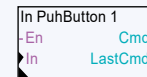
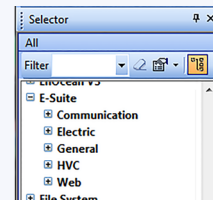

Program

Non-volatile memory (Flash memory)

Program blocks

COB	COB 0
XOB	XOB 10, 12, 13 and 16
PB/FB	100 with maximum hierarchy of 8

Data types

ROM Text/DB	50
-------------	----

Memory

Program memory	64 kBytes
----------------	-----------

The media

Volatile memory (RAM) without battery backup

Data types

Register	2000
Flag	2000
Timer/Counter	200

Memory

Memory (RAM) for 50 Text/DB	5 kBytes
Memory (EEPROM) for parameter (media) backup	256 Bytes
Cyclic synchronisation with PCD controller	Real-time clock (RTC)

Not all functions are available compared to a PCDx.Mxxxx controller. These modules do not have an automation server for example.



More details on which FBoxes are supported is available on our support page www.sbc-support.com

PCD1.G1100-C15 (light and shade module)

The freely programmable module with a housing width of 35 mm (2 HP) can be controlled via RS-485 and enables light and shade control. It has two analogue and two relay outputs and four digital inputs. The user can optionally use the relay for the direct switching of two light groups or control of window shading. The blinds or shading can be positioned and defects localised via the integrated load current measurement. The user can use the digital inputs to connect electrical sensors.



Device design

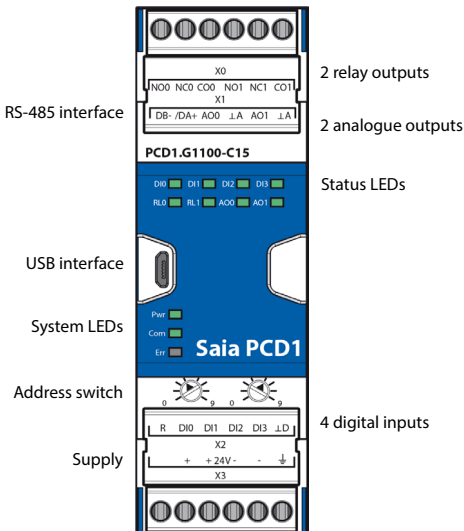

System properties

- ▶ 4 digital inputs
- ▶ 2 relays incl. current detection
- ▶ 2 analogue outputs
- ▶ Galvanic isolation between supply, bus and I/Os
- ▶ Pluggable terminal blocks protected by covers
- ▶ Status LEDs on the front
- ▶ RS-485 and USB interface
- ▶ Freely programmable with Saia PG5®

Technical Data

Interfaces

Communication interface	RS-485 with galvanic isolation Baud rate: 9,600, 19,200, 38,400, 57,600, 115,200 bps (autobauding)
Address switch for S-Bus address	Two rotary switches 0...9
Service interface	USB (Micro-USB)

General specifications

Supply voltage	Nominal 24 VAC (50 Hz) or VDC (in accordance with EN / IEC 61131-2) 24 VDC, -15 / +20% max., incl. 5% ripple 24 VAC, -15 / +10%
Electrically isolated	500 VDC between power supply and RS-485 and between current supply and inputs/outputs
Dimensions	Housing width 2 HP (35 mm), compatible with electrical control cabinet (in accordance with DIN 43880, size 2 × 55 mm)
Mounting type	DIN rail in accordance with DIN EN 60715 TH35 (1 × 35 mm)
Ambient temperature	Operation: 0...+55°C, without forced ventilation Storage: -40...+70°C
Power consumption	Typical 2 W

Inputs and outputs

Inputs	
4 digital inputs	24 VAC / VDC
Outputs	
2 analogue outputs	0...10 VDC, 12 bit resolution
2 relays (inrush)	250 VAC / 30 VDC 8 AAC (AC1) / 8 ADC (resistive load) Max. inrush current 15 A Current measurement ≥ 200 mA, resolution 100 mA

PCD1.W5300-C15 (analogue module)



The programmable analogue module with a housing width of 35 mm (2 HP) has four inputs and outputs. Each input and output is electrically separated and can be configured separately. Small and purely analogue tasks such as recording the room temperature and subsequent control of 0–10 V drives can therefore be realised.

Device design

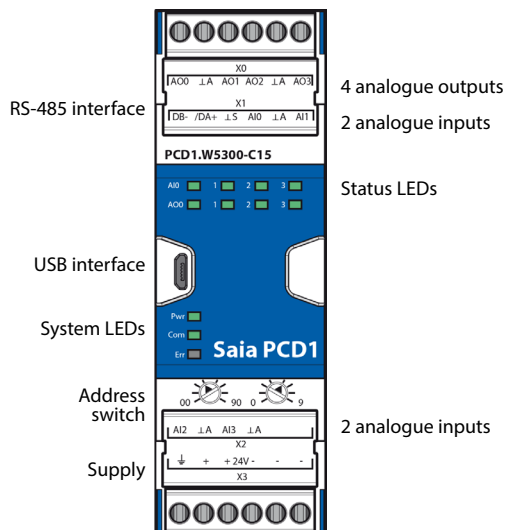

System properties

- ▶ 4 analogue inputs
- ▶ 4 analogue outputs
- ▶ Galvanic isolation between supply, bus and I/Os
- ▶ Pluggable terminal blocks protected by covers
- ▶ Status LEDs at the front
- ▶ RS-485 and USB interface
- ▶ Freely programmable with Saia PG5®

Technical Data

Interfaces

Communication interface	RS-485 with galvanic isolation Baud rate: 9,600, 19,200, 38,400, 57,600, 115,200 bps (autobauding)
Address switch for S-Bus address	Two rotary switches 0...9
Service interface	USB (Micro-USB)

General specifications

Supply voltage	Nominal 24 VAC (50 Hz) or VDC (in accordance with EN / IEC 61131-2) 24 VDC, -15 / +20% max., incl. 5% ripple 24 VAC, -15 / +10%
Electrically isolated	500 VDC between power supply and RS-485 as well as between current supply and inputs/outputs
Dimensions	Housing width 2 HP (35 mm), compatible with electrical control cabinet (in accordance with DIN 43880, size 2 × 55 mm)
Mounting type	DIN rail in accordance with DIN EN 60715 TH35 (1 × 35 mm)
Ambient temperature	Operation: 0...+55°C, without forced ventilation Storage: -40...+70°C
Power consumption	Typical 2 W

Inputs and outputs

Inputs	
4 analogue inputs (adjustable via software)	0...10 V, ±10 V, ±20 mA (0...20 mA, 4...20 mA), Pt/Ni1000, Ni1000 L&S, 0...2500 Ω, 0...7500 Ω, 0 Ω...300 kΩ 12/13 bit resolution, depending on the measured values
Outputs	
4 analogue outputs	0...10 VDC, ±10 V, 12 bit resolution

PCD1.F2611-C15 (DALI module + add. RS-485)

The freely programmable module with a housing width of 35 mm (2 HP) can be controlled via RS-485 and enable the direct control of 64 DALI subscribers. It has the DALI line as well as four digital inputs. The user can implement the digital inputs to connect electrical sensors. The module is freely programmable and can also be used as a “standalone” DALI small controller. For example, smaller DALI lighting systems for enhanced individual rooms can therefore be implemented and subsequent linking to a higher level controller is no longer an obstacle.



Device design

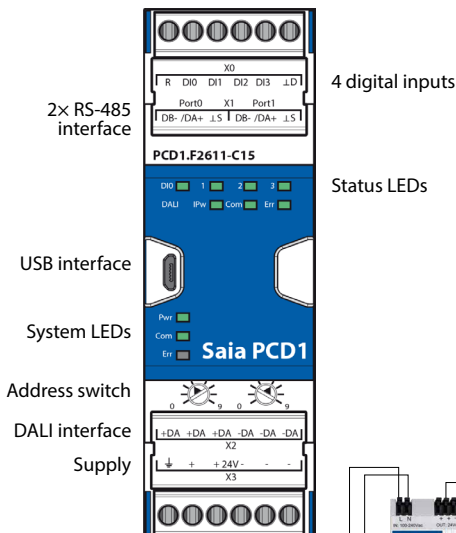

System properties

- ▶ S-Bus (RS-485) / DALI interface
- ▶ incl. DALI voltage supply (can be deactivated)
- ▶ Up to 64 DALI ballasts
- ▶ 4 digital inputs
- ▶ Galvanic isolation between supply, bus and I/Os
- ▶ Pluggable terminal blocks protected by covers
- ▶ Status LEDs on the front
- ▶ RS-485 and USB interface
- ▶ Freely programmable with Saia PG5®

Connection example

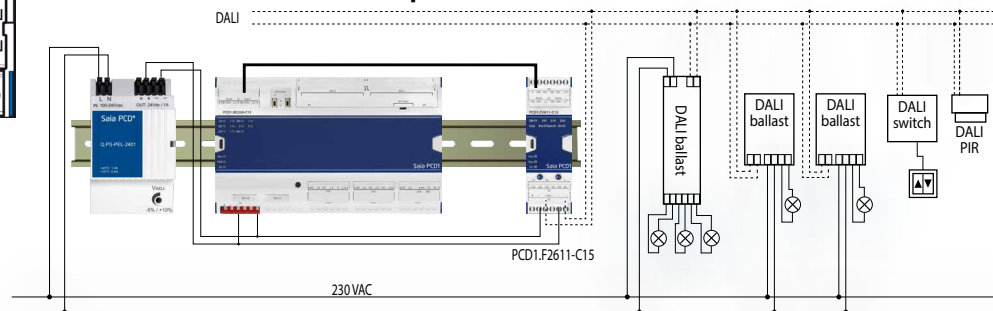

Technical Data

Interfaces

Communication interface	RS-485 with galvanic isolation Baud rate: 9,600, 19,200, 38,400, 57,600, 115,200 bps (autobauding)
Address switch for S-Bus address	Two rotary switches 0...9
Service interface	USB (Micro-USB)
DALI	incl. DALI voltage supply (can be deactivated) for up to 64 DALI subscribers 160 mA max. Output current basic insulation (1350 VAC)
Additional interface	RS-485 in SASI mode C (E-Suite, Modbus, EnOcean, PHC)

General specifications

Supply voltage	Nominal 24 VAC (50 Hz) or VDC (in accordance with EN/IEC 61131-2) 24 VDC, -15/ +20% max., incl. 5% ripple 24 VAC, -15/ +10%
Electrically isolated	500 VDC between current supply and RS-485 and between current supply and inputs/outputs
Dimensions	Housing width 2 HP (35 mm), compatible with electrical cabinet (in accordance with DIN 43880, size 2 × 55 mm)
Mounting type	DIN rail in accordance with DIN EN 60715 TH35 (1 × 35 mm)
Ambient temperature	Operation: 0...+55°C without forced ventilation Storage: -40...+70°C
Power consumption	Typical 2 W

Inputs

4 digital inputs	24 VAC /VDC
------------------	-------------

1.6.4 PCD1 E-Line input and output modules

The remote I/O modules are controlled via RS-485 and enable decentralised automation using industrial quality components. The data point mix is specifically designed for applications in the HVAC sector. Moreover, the compact design enables the use of electrical distribution boxes alongside installations even in confined spaces. Commissioning and servicing are facilitated due to the local override operating level for each output. Remote maintenance is also possible using the optional access to the override operating level via the web interface in the Saia PCD controller. Programming is also very efficient and fast using a comprehensive FBox library with web templates.

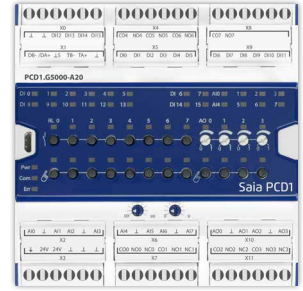

Device design – S-Series

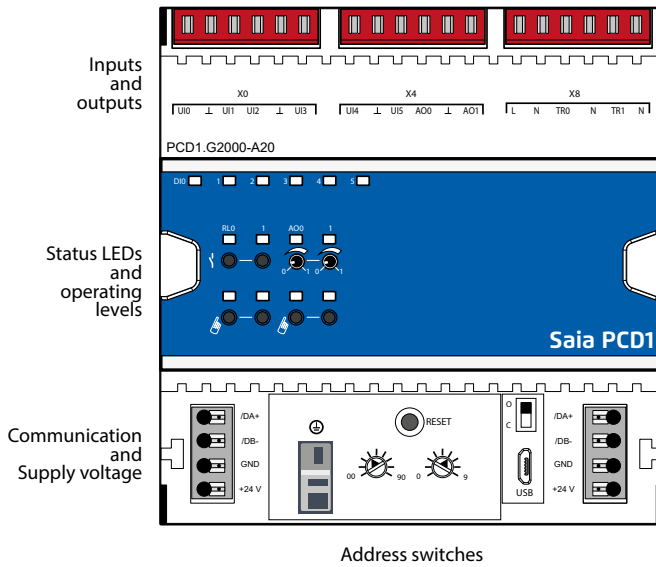

System properties

- ▶ Optimised S-Bus protocol for fast data communication
- ▶ Local override operating level via web panel or buttons on the module
- ▶ Specific I/O mix suitable for HVAC systems
- ▶ Convenient programming using the FBox library and web templates
- ▶ Industrial quality in accordance with IEC EN 61131-2
- ▶ Pluggable terminal blocks protected by covers
- ▶ RS-485 interface
- ▶ Easy installation with connector bridge

Device design – L-Series

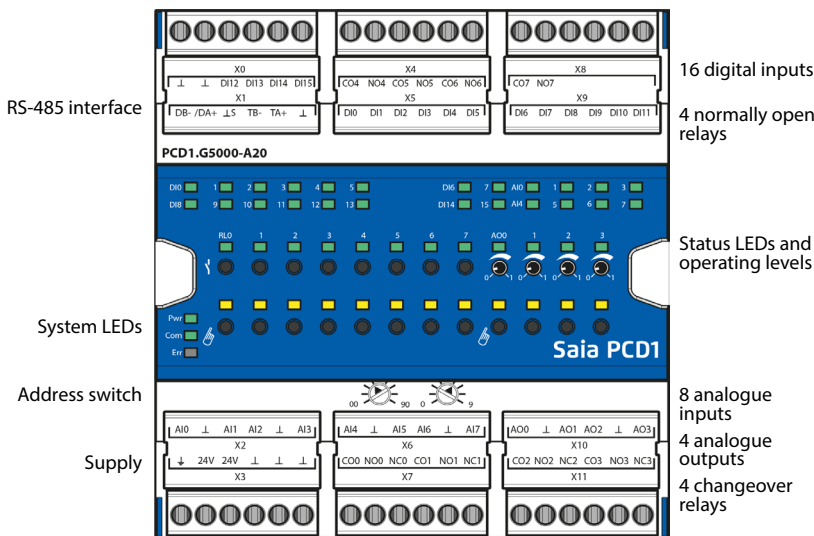

System properties

- ▶ Optimised S-Bus protocol for faster communication (4 × faster)
- ▶ Local override operating level via web panel or buttons on the module
- ▶ Specific I/O mix suitable for HVAC systems
- ▶ Convenient programming using the FBox library and web templates
- ▶ Industrial quality in accordance with IEC EN 61131-2
- ▶ Pluggable terminal blocks protected by covers
- ▶ Electrically isolated RS-485 interface
- ▶ High I/O density thanks to two-sided connection terminals

Manual or remote override operating level

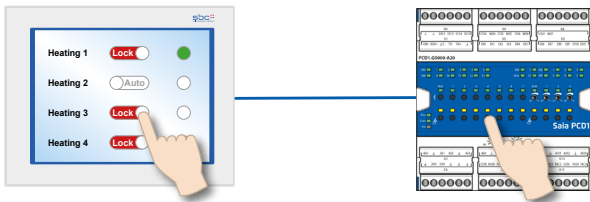

For modules with a manual override operating level, commissioning can occur independent of the master station.

The manual operating level can also be controlled remotely from a touch panel. If the bus line is disconnected, the module retains the manually set values. Traditional manual operating levels in the control cabinet door via potentiometers and switches can therefore be completely replaced.

Five security levels can be defined for the manual operating level:

1. Manual operation completely deactivated
2. Operation permitted only from the module
3. Operation permitted from the module and limited operation from the panel. If manual operation is activated at the module, it cannot be reset from the panel.
4. Unlimited operation from the panel and module.
5. Operation permitted only from "remote".



Depending on the application, manually set values may not be reset from the panel.

This can therefore be deactivated or limited.

General technical data

Power supply

Supply voltage	24 VDC, -15 / +20% max., incl. 5% ripple (in accordance with EN / IEC 61131-2)
Electrically isolated	500 VDC between power supply and RS-485 and between inputs/outputs and RS-485 *
Power consumption max.	3 W

Interfaces

Communication	RS-485 with galvanic isolation * / baud rate: 9,600, 19,200, 38,400, 57,600, 115,200 bps (autobauding)
Address switch for S-Bus	Two rotary switches 0...9
Terminating resistor	Integrated, can be activated via a wire jumper

General specifications

Ambient temperature	Operation: 0...+55°C without forced ventilation / storage: -40...+70 °C
Terminals	Push-in spring-loaded terminals – max. 1.5 mm ² .
Width	6TE (105mm)

* Only for L-Series

Technical data for inputs and outputs

Digital inputs

Input voltage	24 VDC, high active
---------------	---------------------

Relay outputs

Switching voltage max.	250 VAC / 30 VDC
Switching current max.	see below board, datasheet
Contact protection	n/a

Analogue inputs

Resolution	12/13 bit resolution, depending on the measured values
Measured values	0...10 V, Pt/Ni1000, Ni1000 L&S, NTC, 0...2,500 Ω, 0...7,500 Ω, 0 Ω...300 kΩ can be set via FBoxes
Precision	0.3% at 25°C

Analogue outputs

Resolution	10 bits
Signal range	0...10 V (10 mA max.)
Man. Override operation	Operation via buttons and potentiometer

Bus wiring

S-Series : Easy and reliable installation through connector bridges for communication and supply voltage.

L-Series : Most modules are equipped with integrated terminating resistors that enable wiring without additional external components.

Programming

The modules are addressed and programmed via FBoxes.

ref:Channel

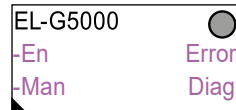

Communication FBox:

- ▶ Data exchange for I/O via optimised S-Bus
- ▶ Configurable fall back state for bus interruption or timeout
- ▶ Direct generation of the symbols
- ▶ Reading and writing of the status of the override operating level
- ▶ Direct compatibility for web macros

Web templates:

- ▶ Web templates are available for the operation and visualisation of the override operating level

S-Series

Type	Digital input (DI), universal input (UI)	Relay, triac, digital output (DO)	Analogue output	Manual override operation
PCD1.A1000-A20	–	10 DO 24 VDC, 0.5 A	–	Yes
PCD1.A2000-A20	–	6 relays 230 V, 16 A	–	Yes
PCD1.B1100-A20	4 DI	10 relays (6 NO, 4 CO)	–	Yes
PCD1.B1120-A20	16 DI	4 relays change over	–	Yes
PCD1.B5000-A20	6 DI 230 V	3 relays 230 V, 6 A	–	Yes
PCD1.B5010-A20	6 DI 24 VAC/DC	3 relays 230 V, 6 A	–	Yes
PCD1.E1000-A10	12 DI 24 VDC	–	–	–
PCD1.G2000-A20	6 UI	2 triacs 24...230 VAC, 1 A	2	Yes
PCD1.G2100-A10	8 UI	–	–	–
PCD1.G2200-A20	8 UI	–	4	Yes
PCD1.W5200-A20	–	–	8	Yes

L-Series

Type	Digital input	Relay (NO / changeover)	Analogue input	Analogue output	Manual override operation
PCD1.B1000-A20	4	10 (6/4), 4A	---	---	Yes
PCD1.B1010-A20	24	10 (6/4), 4A	---	---	Yes
PCD1.B1020-A20	16	4 (0/4), 4A	---	---	Yes
PCD1.G5000-A20	16	8 (4/4), 4A	8	4	Yes
PCD1.G5010-A20	12	4 (0/4), 4A	12	8	Yes
PCD1.G5020-A20	8	4 (0/4), 4A	16	4	Yes

Accessories

Type	Short text	Description	Weight
32304321-003-S	Terminal set – S+L-Serie	6-pin terminal. Set of 6 terminal blocks	40 g

Accessories

Type	Short text	Description	Weight
PCD1.K0206-005	E-Line Cover Set 5x6 HP*	E-Line cover and labelling set consisting of 5x covers (6 HP=105 mm) and labelling sheets for installation in automation control cabinets	365 g
PCD1.K0206-025	E-Line Cover Set 5x6 HP* w.h.	E-Line cover and labelling set w.h. consisting of 5x covers (6 HP =105 mm) with holes for the manual priority operating level and labelling sheets for installation in automation control cabinets	365 g

* Horizontal pitch: 1 HP corresponds to 17.5 mm

Mounting and labelling in the automation control cabinet

The modules can be mounted in the standard automation control cabinet as well as mounting in the electrical sub-distributor. Covers are available for this for easy labelling. They also serve as contact protection for the buttons and terminals to prevent faulty operation.



1.6.5 E-Line system components

Power units for installation in electrical distributor boxes

The compact Q.PS-PEL-240x power units with 24 VDC output voltage can be installed in a very restricted space and therefore the installation in cost-effective electrical distributor boxes in accordance with DIN 43880 is possible. They are therefore ideally suited for combining with the E-Line family. Modern push-in terminals enable efficient and fast wiring without the use of tools.

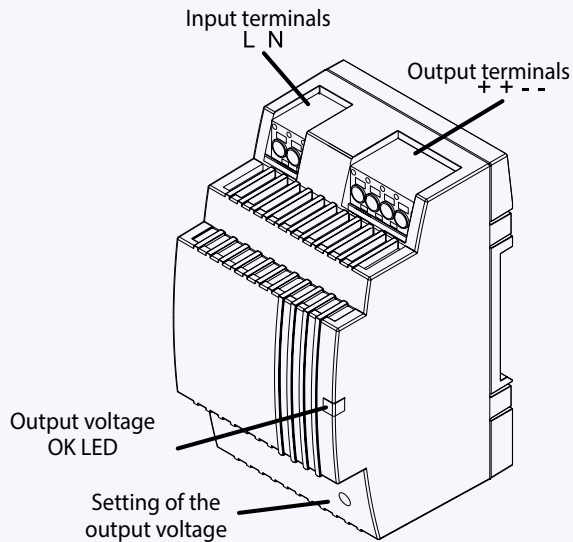

Power unit overview

Single phase 110/230 VAC

- ▶ Q.PS-PEL-2401: 24 VDC / up to 1.3 A
- ▶ Q.PS-PEL-2403: 24 VDC / up to 4.0 A

Standards and certifications

Compliant certifications

- ▶ CE
- ▶ DNV GL (shipping approval)
- ▶ UL (cURus, cULus)
- ▶ EAC

Electrical safety

- ▶ EN61558
- ▶ EN60950 (SELV)

EMC

- ▶ EN61204-3
- ▶ Immunity pursuant to EN61000-6-2 (for the industrial sector)
- ▶ Emitted interference in accordance with EN61000-6-4 (for the domestic sector)

Dimensions

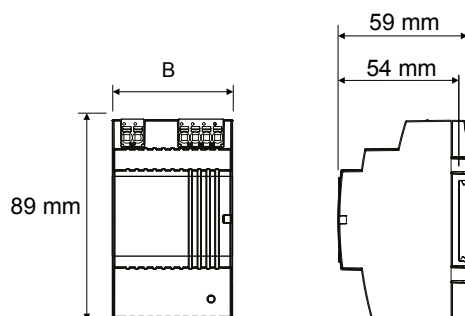

Model	Q.PS-PEL-2401	Q.PS-PEL-2403
Width (W)	54 mm	90 mm

System properties

- ▶ Short-circuit protection and constant overload limiter
- ▶ Protection class II (in closed switch cabinet)
 - dual isolation
- ▶ Power failure bypass up to 100 ms
- ▶ LED for output voltage OK display
- ▶ Stabilised and adjustable output voltage for the conductor resistance compensation
- ▶ Parallel operation possible to increase max. output current
- ▶ IP20 housing for mounting on DIN rail

Mounting in the sub-distributor

The design of the Q.PS-PEL2-40x power units complies with the required standard dimensions according to DIN 43880. The power units can therefore be easily integrated in electrical distribution boxes and are ideally suited to supply the components of the E-Line family with voltage



Terminal technology

Push-in terminals for efficient and fast wiring without tools for single wire conductors with a cross section of up to 2.5 mm² or fine wire ferrules up to 1.5 mm². However fine wire conductors up to 2.5 mm² can also be connected directly by simply applying pressure (screwdriver).

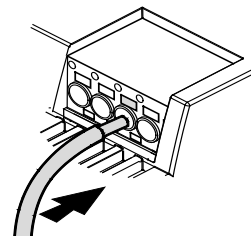

Installation information

Distance to adjacent parts:
 Right/left: no minimum distance required
 Top/bottom: min. 50 mm

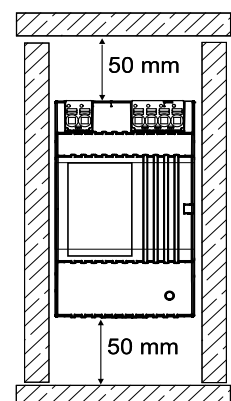

Technical data

Input data	Q.PS-PEL-2401	Q.PS-PEL-2403
Input voltage	100...240 VAC	
Permitted input voltage range	85...264 VAC	
Nominal frequency range	44...66 Hz	
Nominal input current for nominal load (110 / 230 VAC)	0.7 / 0.5 A	1.6 / 0.9 A
Internal input fuse	2 AT	4 AT
Recommended external pre-fuse	6 A, 10 A, 16 A, characteristics B, C	
Power failure bypass for nominal load (110 / 230 VAC)	10 / 80 ms	15 / 100 ms
Output data		
Output voltage (V_N)	24 VDC \pm 2%	
Output voltage range (V_{ADJ})	22.8...26.4 VDC	
Output current (I_N) at $\leq 45^\circ\text{C}$	1.3 A	4 A
Output current (I_N) at $\leq 55^\circ\text{C}$	0.9 A	2.8 A
Current load rating for any installation system	max. 0.9 A	max. 2.4 A
Efficiency	typical 82%	typical 88%
Residual ripple (for nominal load)	≤ 100 mVpp	
Overload behaviour	Constant current (U/I characteristic curve)	
Short-circuit protection	Yes	
Overvoltage output protection	Yes (max. 30 VDC)	
Parallel connection	Yes	
Status		
Operating indicator	LED green	
Environment		
Ambient temperature (operation)	-25°C to $+55^\circ\text{C}$ (load reduction $>45^\circ\text{C}$, 3%/°C)	
Storage temperature	-25°C to $+80^\circ\text{C}$	
Permitted humidity	30–85% relative humidity, no condensation permitted	
Areas of use	Use in areas with contamination level 2	
Connection terminals		
Connections	Push-in	
Input/output terminals	Single wire and fine wire conductors up to max. 2.5 mm ² / conductors with wire ferrules up to max. 1.5 mm ²	

Output characteristics

Voltage/current characteristic curve for short-circuit and overload protection

Output Characteristic (U/I Characteristic)

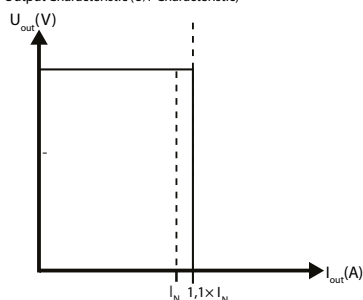

The current overload protection limits the current to a constant value of $1.1 \times$ nominal current

Output derating curve

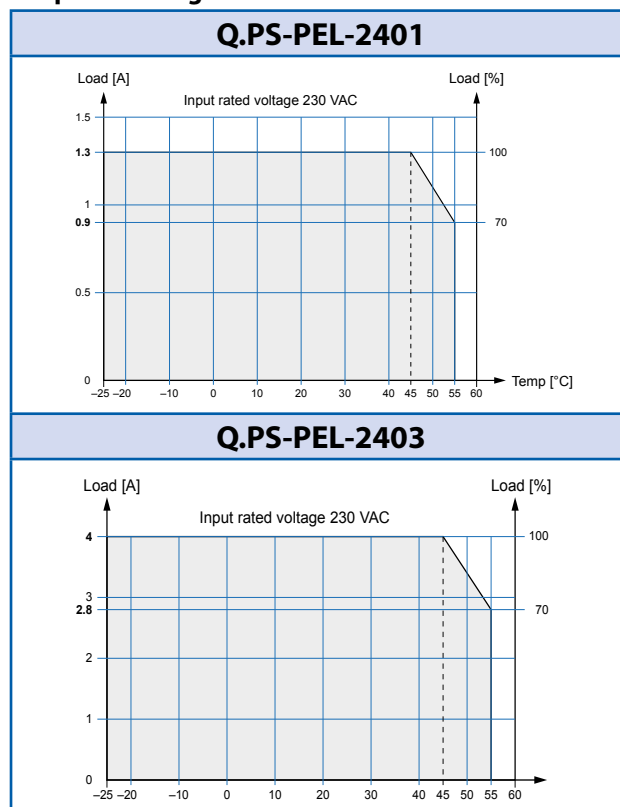

A2 Operation and monitoring

SBC microbrowser devices form the core and main part of the HMI range. Windows-based systems complete the range.

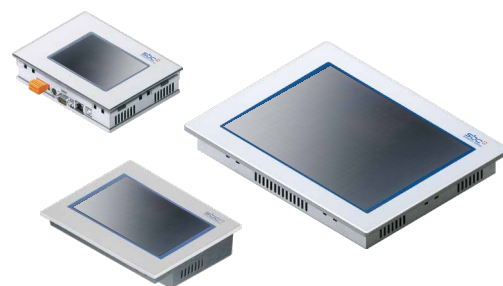

2.1 Overview of types, dimensions and resource

Device series from 5 to 12"es. SBC microbrowser and standard IT interfaces with onboard.



Page 86

2.2 Web Panels MB | Web technology

Trending, alarming and system images for the operator. Specific websites for maintenance and service. Local data storage in Excel-compatible CSV format with FTP access for monitoring and logging functions. Saia PCD COSinus dedicated operating system for automation/MSR technology developed by Saia Burgess Controls.



87

2.3 Web Panels MB | Standard device

The operation of HMI applications is also possible from multiple connected Saia PCD automation stations. The applications are created using the Saia PG5® Web Editor and made available in webserver of Saia PCD automation devices for the web panel microbrowser (MB).



88

Device series accessories: Chapter 2.6 – Page 94

2.4 pWeb Panels MB

In addition to the functions of the standard MB panel, a fully programmable logic controller is integrated. It can be used to realize specific, complex operating and local data processing logic. It can be used as a management/control station for large and distributed systems.



90

Accessories for the device series: Chapter 2.6 – Page 94

2.5 Room Panels

Attractively designed and fully programmable, the panels will fit beautifully into any room. Autonomous room applications with the integrated logic controller enable users to control the room functions without a head-end station.



92

2.7 Cyber secure HTML5 touch Web panels

Latest HMI generation of Saia PCD with elegant and robust design for control cabinet installations. Modern HTML5 browser based on Linux. HTML5 touch panel provides high cyber security level to prevent from unauthorized access. Controllers, HMI and tools are harmonized while the compatibility with HTML5 Web-Editor is ensured. Saia PCD web Panels are ready to use.



98

2.1 Overview of types, sizes and resources

Saia PCD® Web Panels MB|Standard devices

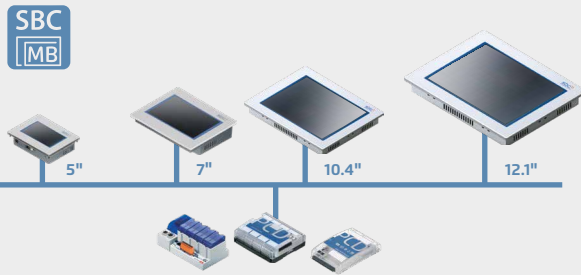

Saia PCD® Web Panels MB|Standard devices

Robust control panel for displaying web visualisations created with the Saia PG5® Web Editor. Ready to use with no software installation required.

Display sizes 5.0" / 7.0" / 10.4" / 12.1"

- ▶ Ethernet, USB and serial
- ▶ FTP server
- ▶ File system

Saia PCD® pWeb Panels MB | with programmable logic controller

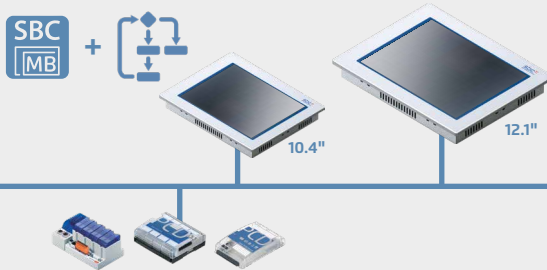

Saia PCD® pWeb Panels MB|with programmable logic controller

The programmable Web Panels combine an automation server for visualisation with control and management functions in a single device.

Display sizes 10.4" / 12.1"

- ▶ 2× Ethernet (switch), USB and RS-485
- ▶ Integrated logic controller
- ▶ Programmable with Saia PG5®
- ▶ Automation server
- ▶ 128 MB of flash memory

Saia PCD® Web Panels MB – room

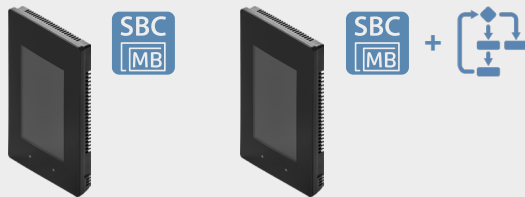

Fully programmable devices in a high-quality design for use in room applications. The visualisation can be custom-designed with the web editor.

- ▶ Display size 4.3"
- ▶ 1 × Ethernet, 1 × RS-485, USB
- ▶ PCAP touch technology
- ▶ User file system 4...128 MB
- ▶ Temperature and ambient sensors

Saia PCD® Web Panels MB – Functional HMI|Visualisation and operation with ready-to-use functions

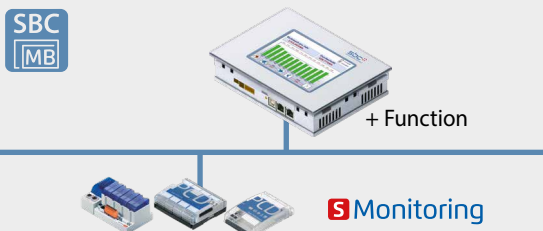

One step closer to the application

Functional HMI systems provide functions that support the user in the implementation of complex applications such as recording and visualising data records. The devices come with a preinstalled application. This application can be modified or expanded.

→ For more information, see Chapter 4

Cyber secure HTML5 touch Web panels

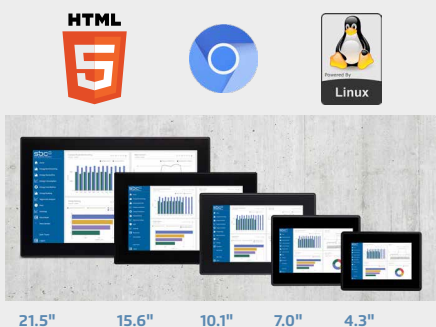

Modern HTML5 browser based on Linux. Chromium Browser to access PCD Web-Server or Saia PCD Supervisor. High cyber security level with protection from unauthorized accesses

Display sizes 4.3" / 7.0" / 10.1" / 15.6" / 21.5"

- ▶ Up to 3× Ethernet & USB
- ▶ 800 MHz and 1 GHz CPU
- ▶ 4 GB flash memory
- ▶ Resistive & True Glass Projected Capacitive Multitouch Screens
- ▶ Brilliant up to 2,100,000 pixels display
- ▶ Compatible with HTML5 Web-Editors projects.

2.2 Web Panels MB | Web technology

Combination of openness, international standards and universality

A system for operation/monitoring with web technology consists of essentially just two functional elements: a web server and a browser. The protocol linking them is http. These two functional elements can be combined in the same automation device or located on opposite sides of the globe.

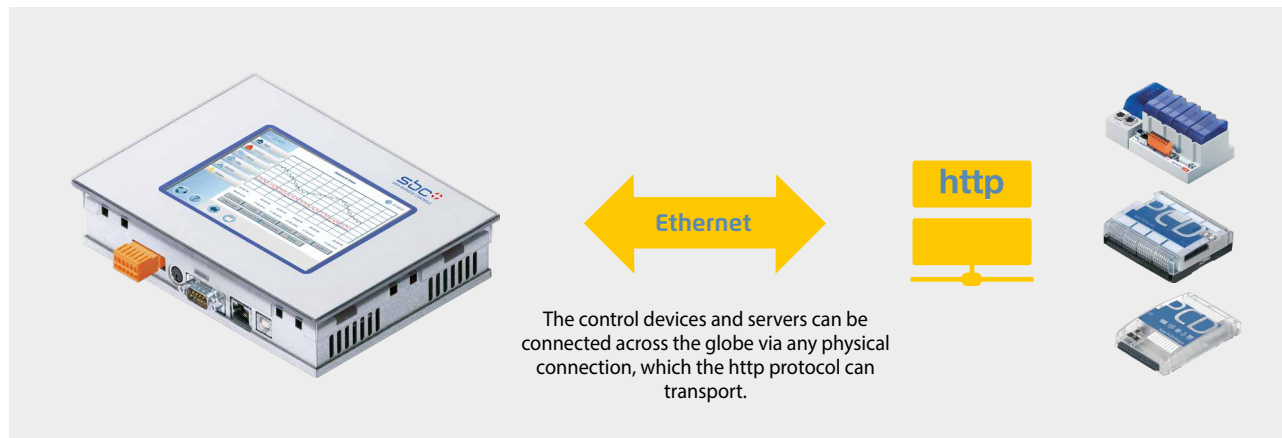

The operation/monitoring project is created once using the Saia PG5® Web Editor and saved to the associated Saia PCD web server. Each browser can freely access any web server of the automation devices recognised in the network and run its web HMI application. A web server can handle multiple browsers simultaneously. Web HMI eliminates complex engineering, duplication of project expenses, software licensing problems and system breaks during operation/monitoring.

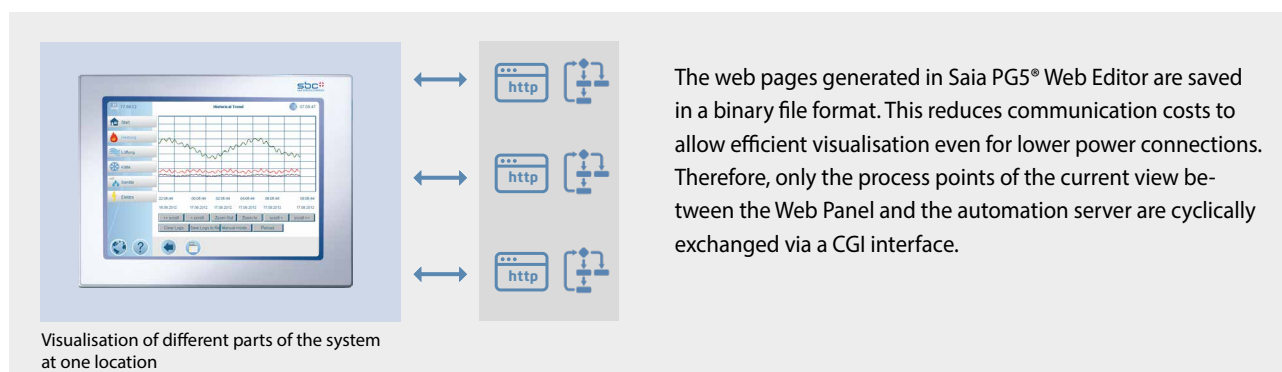

Saia PCD® COSinus



Systems are often expanded or equipped with new functions and must be maintained throughout their entire service life. The Saia PCD COSinus operating system was specifically developed from scratch

in-house for use in automation environments. It is therefore possible to ensure the industrial service life without being pressurised by large companies that influence the market. The top priority for Saia PCD COSinus is a reliable and continuous operation. The SBC microbrowser Panel series are essentially based on this reliable system which has been expanded with the microbrowser application. This allows the visualisation and operation of web projects which have been created with Saia PG5® Web Editor. Here, the visualisation project can be saved locally or on a remote server.

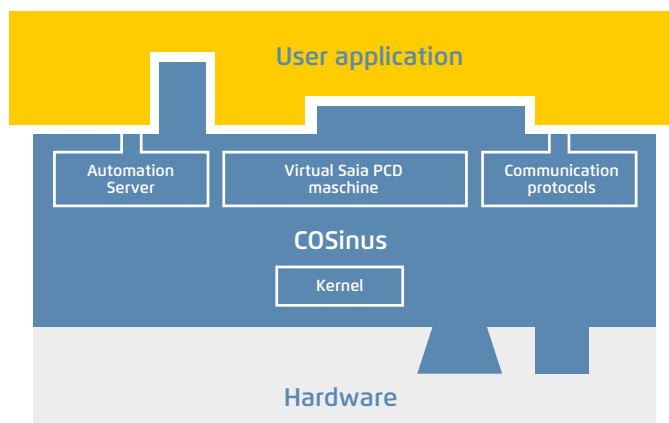

2.3 Web Panels MB | Standard devices

The microbrowser standard device series is the visualisation and control interface for automations with Saia PC D controllers. The panels – finished to industrial quality – are available in various sizes to handle various requirements. The internal memory allows all devices to display data trending and alarm history so that dynamic visualisation can be implemented. An application saved in the controller can be displayed on the panel without any additional configuration tool.

Main features

- ▶ Large selection of display sizes, colour TFT display, in VGA or SVGA resolution
- ▶ Fast and easy commissioning without additional applications with an internal setup menu
- ▶ Connection to the web server via Ethernet

Device design

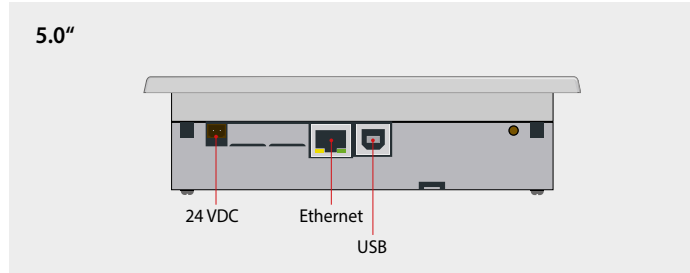

Device installation

10.4"

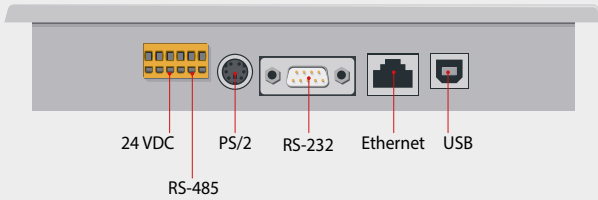

12.1"

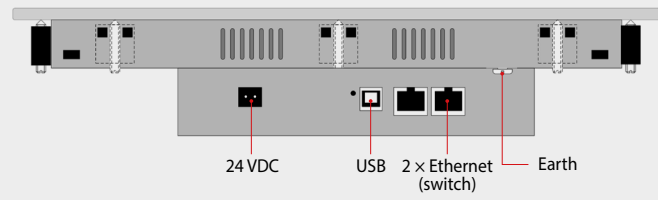

EPLAN macros

EPLAN macros are available for project planning and engineering



The eplan® electric P8 macros are available on the support page.

The macros and article data are also provided on the eplan® data portal.

SBC MB App

Operation and monitoring on iPhone, iPad and Android



Setup menu

The panel is configured in two stages via the setup menu directly on the panel. No additional software or a connection to a laptop is required for commissioning.

1st Stage: Network configuration

Setup	Network	Help
Enable DHCP	<input type="checkbox"/>	
TCP/IP Address	192.168.12.90	▶
Subnet mask	255.255.255.0	▶
Default gateway	0.0.0.0	▶
DNS Enable	<input type="checkbox"/>	
Primary DNS Server	0.0.0.0	▶

2nd Stage: Web server configuration

Startup Connection	Edit Connection
Connection Name	▶
Start Page	Start.html ▶
Remote host IP	127.0.0.1 ▶
Remote port	80 ▶
Remote password	▶

Dimensions (W × H × D) and cut-out (W × H) mm

PCD7.D450WTPF

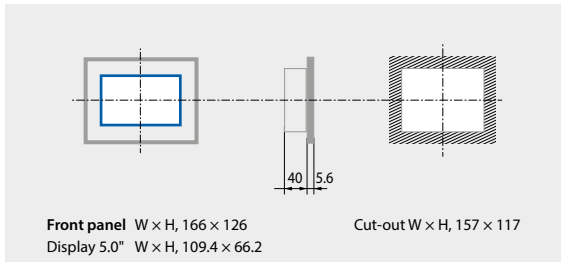

PCD7.D410VTCF

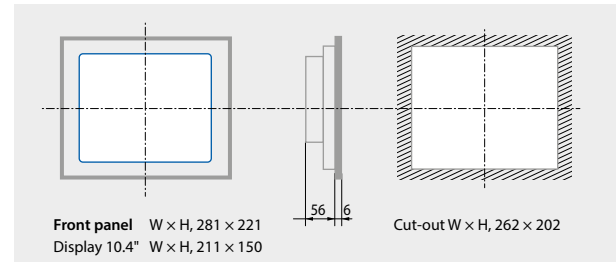

PCD7.D470WTPF

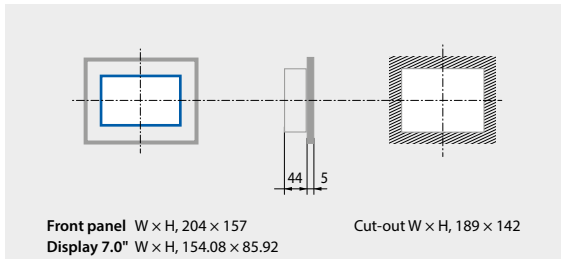

PCD7.D412DTPF

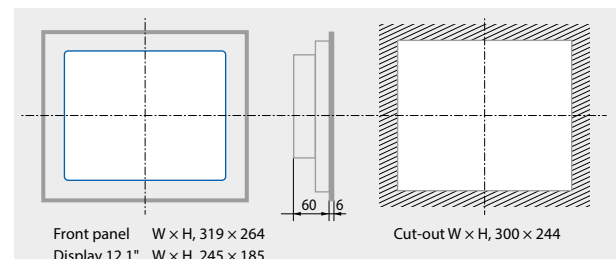

General specifications

Operating system	Saia PCD COSinus with microbrowser expansion
Protection type (front)	IP 65
Temperature range	Operation 0 ... +50 °C (7.0": -20...70 °C) Storage -25 ... +70 °C
Humidity	Operation 10 ... 80 % Storage 10 ... 80 % non-condensing
Contrast adjustment	Yes
FTP server	Yes
Supply voltage	24 VDC ±20 %



Technical Data

	PCD7.D450WTPF	PCD7.D470WTPF	PCD7.D410VTCF	PCD7.D412DTPF
Display size	5.0" TFT	7.0" TFT	10.4" TFT	12.1" TFT
Resolution (pixels)	WVGA 800 × 480	WVGA 800 × 480	VGA 640 × 480	SVGA 800 × 600
Touch screen	Resistive touch screen	Resistive touch screen	Resistive touch screen	Resistive touch screen
Background lighting	LED	LED	LED	LED
Colours:	65,536	65,536	65,536	65,536
Onboard file system	128 MB	128 MB	4 MB	128 MB
Processor	240 MHz	240 MHz	66 MHz	240 MHz
Interfaces	USB 1.1/2.0 Device Ethernet 10/100 M	USB 1.1/2.0 Device Ethernet 10/100 M	RS-232, RS-485 USB 1.1 Device Ethernet 10/100 M	USB 1.1/2.0 Device Ethernet 10/100 M
Current requirements	approx. 350 mA	approx. 400 mA	approx. 500 mA	approx. 600 mA
Real-time clock (RTC)	Yes (Supercap)	Yes (Supercap)	No	Yes (Supercap)

2.4 pWeb Panels MB

In addition to the functions of the standard MB panel, a programmable logic controller is integrated into the pWeb Panels. Based on the COSinus operating system of the Saia PCD, specific, complex control logic and local data processing logic can be implemented in one device. The priority here are the operating and visualisation functions that enable small control systems to be implemented. The control functions have a lower priority.

Main features

- ▶ Ethernet interfaces (2 port switch)
- ▶ RS-485 interface
- ▶ 240 MHz processing power
- ▶ Expandable via PCD7.F1xxS modules
- ▶ Can be used as a RIO Master



Device installation

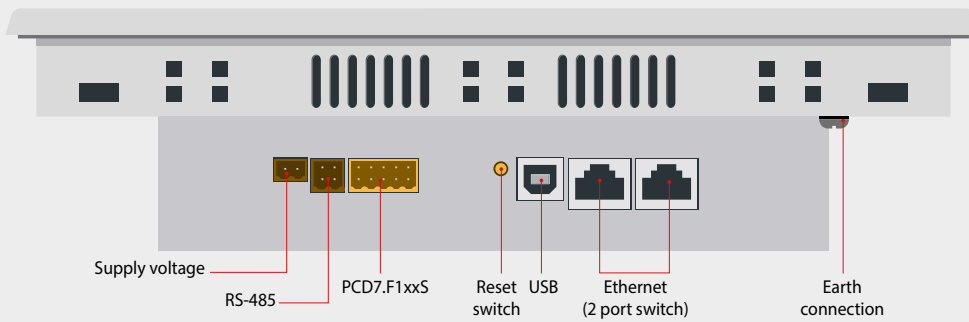

The high priority given to visualisation in the program workflow offers the best basis for displaying data from various devices. Simple control tasks can also be implemented directly in the panel. It is not advisable to use pWeb panels when constructing closed control loops or utilising HVAC and DDC Suite controllers. In these cases, a Saia PCD controller is recommended.

Application examples

Data concentrator

The logic enables users to collect and link the data and status of multiple connected Saia PCD controllers and to visualise the data at a higher level.

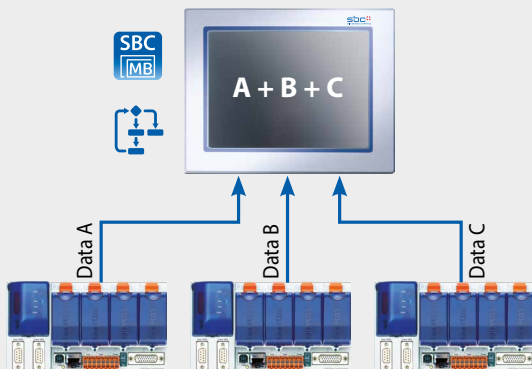

Acquire and visualise data

Values of any type can be counted and displayed by loading the S-monitoring application. Each system's consumption is thereby made transparent. For more information, see chapter 4 "Acquisition of Consumption Data"

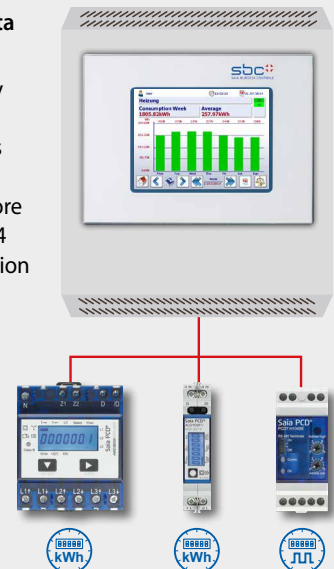

Dimensions (W × H × D) and cut-out (W × H) mm



PCD7.D410VT5F

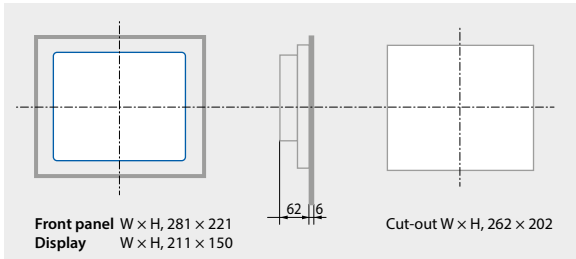

PCD7.D412DT5F

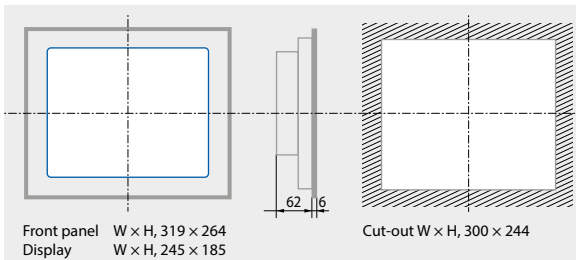

General specifications

Operating system	Saia PCD COSinus with microbrowser extensions
Protection class	IP65
User program, ROM/DB/Text	1 MB
RAM/DB/Text	1 MB
Media	16,384 flags / 16,384 registers
Backup for users	The user program is saved on the integrated microSD card
File system for users	128 MB onboard
Program cycle time	10 cycles/sec. maximum
Field level protocols	Serial S-Bus, Ether S-Bus, Ether S-IO, Modbus RTU or TCP
Internet services	SBC microbrowser, automation server

Interfaces

Ethernet	2 × RJ45 (Switch)
USB	1 × (1.1 / 2.0)
Serial interfaces	RS-485 1 slot for PCD7.F1xxS
Temperature range	Operation: 0 ... 50°C typically Storage: -25 ... 70°C
Humidity	Operation 10 ... 80 % Storage 10 ... 80 % non-condensing
Processor	Coldfire CF5373L, 240 MHz
Battery	Lithium Renata CR 2032 (service life of 1...3 years)
Real-time clock (RTC)	with battery buffer

Technical Data

	PCD7.D410VT5F	PCD7.D412DT5F
Display size	10.4" TFT	12.1" TFT
Resolution/pixels	VGA 640 × 480	SVGA 800 × 600
Touch screen	Resistive touch screen	Resistive touch screen
Contrast adjustment	Yes	Yes
Background lighting	LED	LED
Power supply	24 VDC ±20%	24 VDC ±20%
Current draw	approx. 500 mA	approx. 600 mA
Status front LED	---	Yes

Communication

The Saia PCD pWeb Panel MB units can be expanded with one slot for various communication modules PCD7.F1xxS and memory modules PCD7.Rxxx. The modules are described in the section Saia PCD1.

2.5 Room Panels

Attractively designed, in the housing colour white or black, the panels will fit beautifully into any room.

Autonomous room applications with the integrated logic controller (fully programmable) enable users to control the room functions without a head-end station and therefore the associated delays through long communication channels.



Main features

- ▶ Fully programmable visualisation with the Web Editor 8
- ▶ Fully programmable logic controller for autonomous room applications
- ▶ Mounting in standard wall boxes
- ▶ Onboard temperature sensor
- ▶ TFT colours with a colour depth of 65,000
- ▶ Capacitive touch screen technology for a very sensitive response

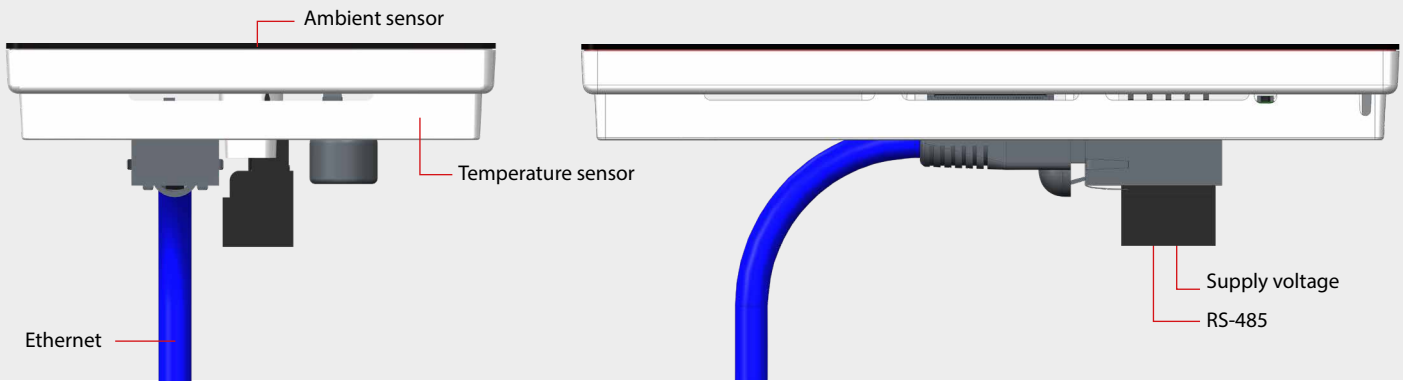

Mounting

The installation of the panels is carried out using an adapter included in the package on standardised, double wall boxes.

Such as electrical material Type No. L 8102

HSB-Weibel AG No. 372 104 747

Agro No. 9922

Blass-Elektro No. 22031

Bticino No. 504E

The panel is anchored in the adapter, and can only be removed with the use of tools.

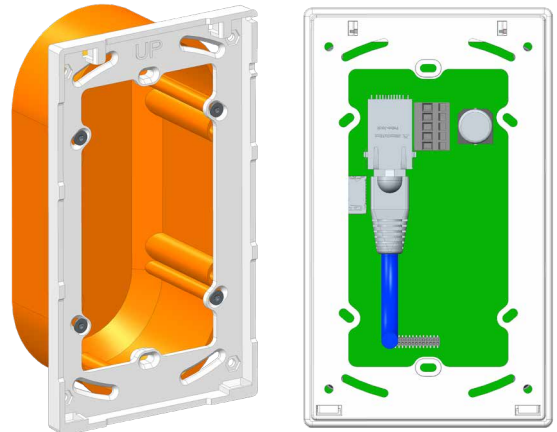

Application examples

Operation and regulation of autonomous room applications. Implementation using the programmable microbrowser room panel and the E-Line RIO modules. Connection based on the RS-485 interface to the E-line modules in the room, and Ethernet connection to the floor controller.

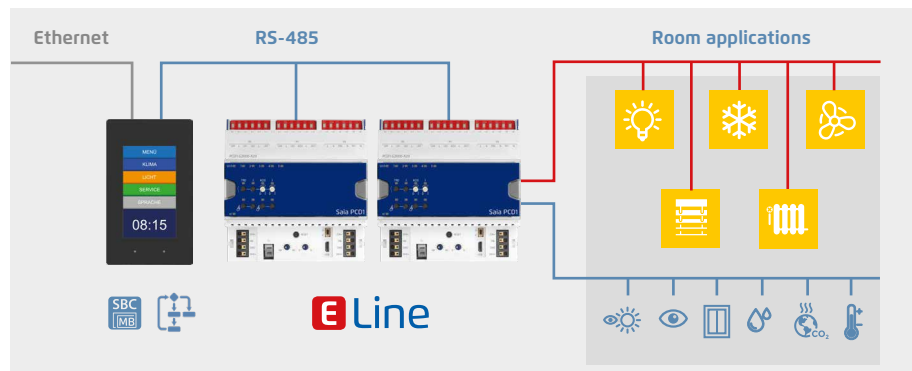

You will find more examples in Chapter B4 "Room Automation"

Dimensions

PCD7.D443WTxRx

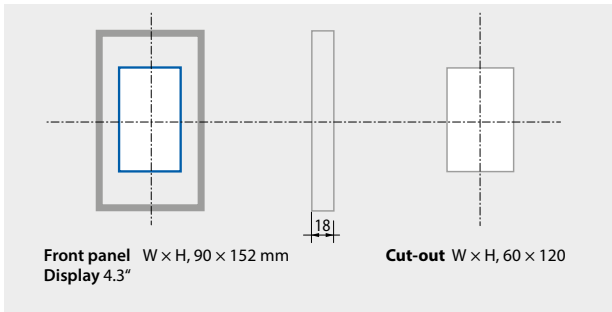

The panel can also be mounted transversely

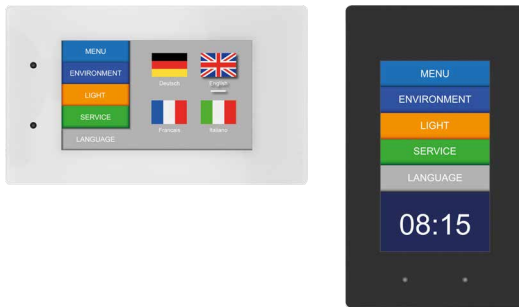

The location of the panel can slightly influence the temperature measurement, an easy calibration allows to remedies this and so increases the accuracy.

In any case ensure that the ventilation slots are not obstructed (LED on the left side!).

General technical data

PCD7.D443WTxR PCD7.D443WTxRW

Operating system	Saia PCD COSinus with micro browser expansion
------------------	---

Display	
Display size [inch]	4,3"
Resolution [pixels]	WQVGA / 480 × 272 pixels
Contrast adjustment	Yes
Background lighting	LED (dimming in 20 steps)
Touchscreen	PCAP technology

Interfaces	
USB	1 × (1.1 / 2.0)
Ethernet	Ethernet 10/100 full-duplex, auto-sensing/auto-crossing
Real-time clock	Yes (SuperCap)

Sensors	
Temperature	Accuracy: ±1°C easy calibration
Power supply	
Supply voltage	24 VDC ±20%
Current draw	Approx. 4 watts / 160 mA

Environment	
Temperature range	Operation: 0...50°C typically Storage: -25...+70°C
Humidity	Operation: 10...80%, storage: 10...80%, non-condensing
Protection class	IP20

Mechanic	
Weight	approx. 200 g

Technical Data

	White case	PCD7.D443WTPRW	PCD7.D443WT5RW
	Black case	PCD7.D443WT5PR	PCD7.D443WT5R
File system		4 MB	128 MB
Logic controller (no remanence)		No	Yes
User program, ROM/DB/Text		No	128 KB
RAM/DB/Text		No	128 KB
Media		No	16,384 flags / 16,384 registers
Memory for parameter (media) backup		No	1,000 non-volatile registers
Serial interfaces		No	RS-485

! To restrict the maintenance there is no internal battery on the devices and therefore the Media are non-retentive. However, the "EL Backup Restore Media" FBox from the E-Suite Library allows to easily backup in the non-volatile registers the values which has to be stored, like the adjust parameters.

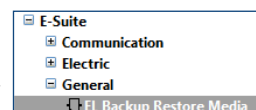

2.6 Accessories for microbrowser panels

2.6.1 Installation systems for the microbrowser family

The correct mounting kit for all Web HMI devices

The microbrowser panel series not only fits in a switch cabinet, but also enables this modern technology to be easily and correctly integrated into the area in close proximity to the user using industrial in-wall and off-wall mounting kits. The mounting kits therefore enable simple wall mounting, which is consistently available for all panels. These kits minimise logistics and mounting costs.

7"

In-wall
PCD7.D457-IWS2



On-wall
PCD7.D457-OWS2

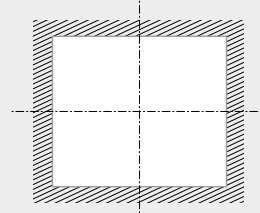
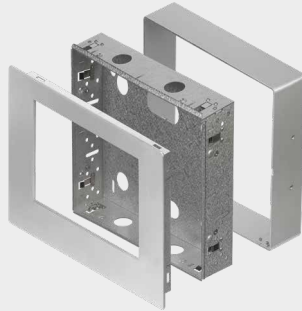

Cut-out $W \times H, 270 \times 211$
Minimum depth
For solid walls 75 mm
For cavity walls 65 mm

10.4"

In-wall
PCD7.D410-IWS



On-wall
PCD7.D410-OWS

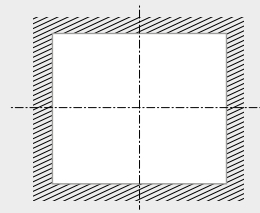

Cut-out $W \times H, 270 \times 211$
Minimum depth
For solid walls 75 mm
For cavity walls 65 mm

12.1"

In-wall
PCD7.D412-IWS



On-wall
PCD7.D412-OWS

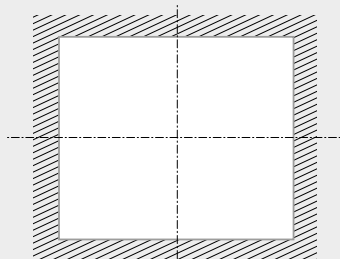

Cut-out $W \times H, 309 \times 245$
Minimum depth
For solid walls 75 mm
For cavity walls 65 mm

On-wall mounting kit 7"

on-wall PCD7.D457-OWS

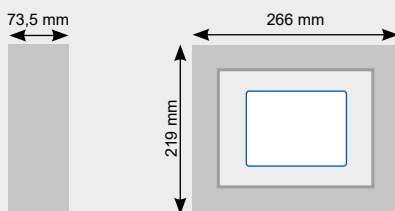
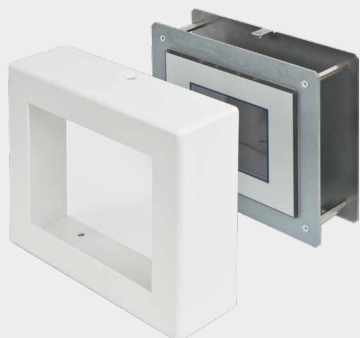

Width 266 mm
Height 219 mm
Depth 73.5 mm

Wall mounting kit 7"

PCD7.D457-OWS1

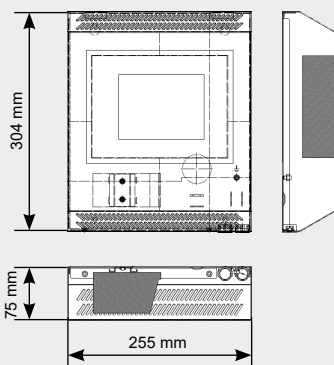

OEM or proprietary design

Panels with a neutral front can also be delivered in small quantities.

The standard Micro Browser Panel provide space for your own creativity. In large quantities, the panels can be visually adapted to individual room needs, with customized front foils.

Panels with neutral front

PCD7.D450WTPZ11
PCD7.D470WTPZ11
PCD7.D410VTCZ11
PCD7.D412DTPZ11
PCD7.D410VT5Z11
PCD7.D412DT5Z11



2.6.2 Fixation sets for Web Panels MB

Order details

Type	Description
3230 9178-001	Fixation set (4 pieces) for the models PCD7.D450, 2 sets necessary for the model PCD7.D412
3230 9178-002	Fixation set (6 pieces) for the models PCD7.D470, PCD7.D410













2.6.3 SBC Micro-Browser App

The SBC Micro Browser App is a small browser application that allows to display and operate web based applications created with the Saia PG5® Web Editor5/Web Editor8 and stored on a Saia PCD Device. The Micro Browser App behaves like a browser using Java (IMaster.jar). The “look and feel” of the visualisation is similar to Micro-Browser panels PCD7.D4xx.

Of course, web based Alarming and Trending functionality’s are included. The integrated station list makes it easy to navigate fast between different web servers, or allows to create user specific access on one overview page to different parts in an application, system or device.

2.6.3.1 SBC Micro-Browser App for Apple and Android

The SBC microbrowser apps overcome the limitations of the industrial world. Most tablets or smartphones are optimised for a long mobile runtime with high performance. The microbrowser app is therefore the ideal way to plug the gap between stationary and mobile areas of use. This provides the foundation for 24-hour monitoring and direct intervention in system operation.

				
Technical Data	SBC MB LITE	SBC MB	SBC MB LITE	SBC MB
Operating system version	 > iOS Version 3.2		 > Android V.2.2	
Resolution / pixels	Depending on the devices used			
Update management	AppStore		Google Play	
Restrictions	No station list No URL skipping 	No limitations 	No station list No URL skipping 	No limitations 

2.6.2.2 SBC Micro-Browser App for Windows

The SBC Micro Browser App for Windows runs on Windows based operating systems (W7, W8, W10, ...).

The Micro Browser App for Windows includes following specific additional features:

- ▶ Print of the current visible window content
- ▶ Screen Capture of the current visible window content
- ▶ Different scaling modes “Auto resize”, “Best fit” and “Fixed size”

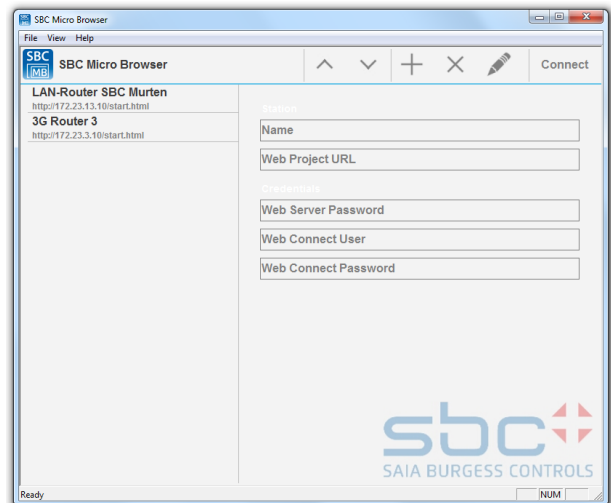

2.6.4 Ways of using the Web Panels with S-Web technology

Using S-Web technology combined with the microbrowser panel systems, operation can be transparent and clear for all users. Each individual operating side has a fully flexible design and can be created using the standard objects or existing function templates.



DDC Suite / HVAC templates created with Saia PG5® Web Editor 8



My HMI: Web pages created with Saia PG5® Web Editor 8

For further information, see the chapter "S-Web technology"

2.6.5 Extensive visualisation options with Windows-based devices

The Windows operating system allows users to confront the constant challenges of the world of automation. This is made possible by the vast application landscape (apps) which provides quick solutions for any application. Should you find no application on the market for your purposes, you can create a high-level language quickly and effectively based on .Net.

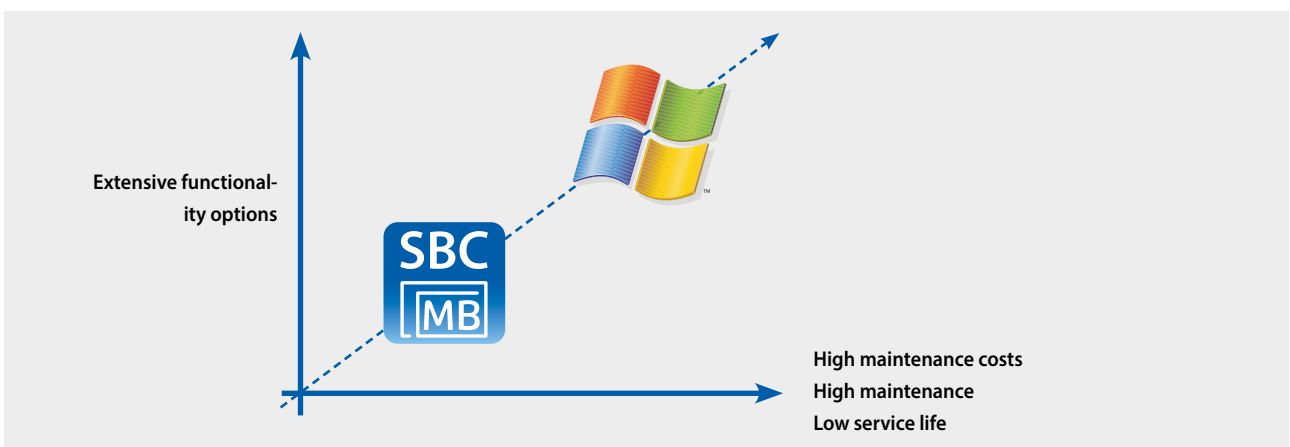

However, please exercise caution when using Windows-based systems. Development of the Windows operating systems is constantly progressing to meet the variety of different requirements. As a result, applications may have to be constantly adjusted for changes in the system. The maintenance requirements of Windows-based systems are greater compared to microbrowser devices, but provide increased functionality.

2.7 New Cyber secure HTML5 touch Web Panels | PCD7.D5

High cyber security and HTML5 Web-Editor projects:

The new HMI generation of Saia PCD offers an elegant and robust design for control cabinet installations. With its modern HTML5 browser based on Linux, the touch panel provides high cyber security level to prevent from unauthorized access.

High quality, industrial grade and long life cycles (>10 years) are at the core of the panels.

Controllers, HMI and tools are harmonized while the compatibility with HTML5 Web-Editor is ensured.



Main features

- ▶ Powerful and fast ARM Cortex-A9 Processor
- ▶ Interfaces: Ethernet, USB
- ▶ Power supply: 24 VDC
- ▶ HTML5 Chromium Browser to access PCD Webserver or any other webserver
- ▶ Compatible with HTML5 Web-Editor projects
- ▶ Brilliant up to 2,100,000 pixels display
- ▶ Wide angle visibility
- ▶ Capacitive touch versions in total glass design. Resistant to scratches, UV and chemicals
- ▶ IP66 protection from the front
- ▶ Operating temperature -20°C to $+60^{\circ}\text{C}$
- ▶ Real Time Clock, RTC Back-up, Buzzer
- ▶ Certifications: IECEx, ATEX, DNV-GL, Lloyd's Register, UL



21.5"

15.6"

10.1"

7.0"

4.3"

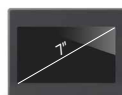

Technical Data

Technical Data	PCD7.D543RF	PCD7.D570RF	PCD7.D570CF1
	Resistive touch		Capacitive (multi touch)
Display size (inch)	4.3" TFT, 16:9, LED, 64 K	7" TFT, 15:9, LED, 64 K	7" TFT, 15:9, LED, 16 M
Operating system	Linux	Linux	Linux
Resolution (pixels)	480 × 272	800 × 480, WVGA	800 × 480, WVGA
Brightness	200 cd/m ²	200 cd/m ²	500 cd/m ²
Touchscreen	Resistive	Resistive	True Glass projected Capacitive, Multi touch
USB Port	1× (Host v. 2.0, max. 500 mA)	1× (Host v. 2.0, max. 100 mA)	2× (Host v. 2.0, max. 500 mA)
CPU	ARM Cortex-A8, 1 GHz	ARM Cortex-A9, dual core, 800 MHz	i.MX8M Mini Quad ARM Cortex-A53
RAM	512 MB	1 GB	2 GB
Flash	4 GB	4 GB	4 GB
Power Supply	24 Vdc (10... 32 Vdc)	24 Vdc (10... 32 Vdc)	24 Vdc (10... 32 Vdc)
Current consumption	0.25 A max. at 24 Vdc	0.3 A max. at 24 Vdc	0.7 A max. at 24 Vdc
Operating temp.	0...+50°C	0...+50°C	-20...+60°C

Dimensions (W × H × D) and cut-out (A × B) mm

PCD7.D543RF | 4,3" HTML5 Web Panel, resistive touch

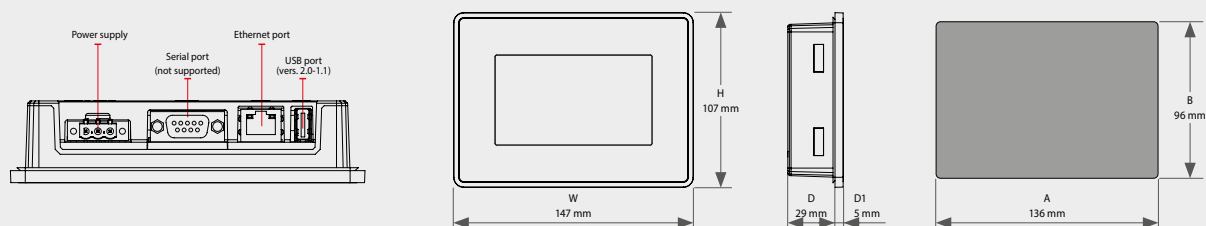

PCD7.D570RF | 7" HTML5 Web Panel, resistive touch

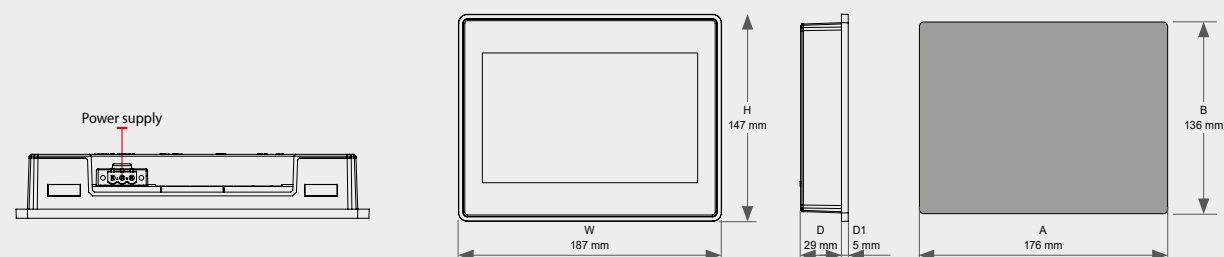

PCD7.D570CF1 | 7" HTML5 Web Panel, capacitive touch

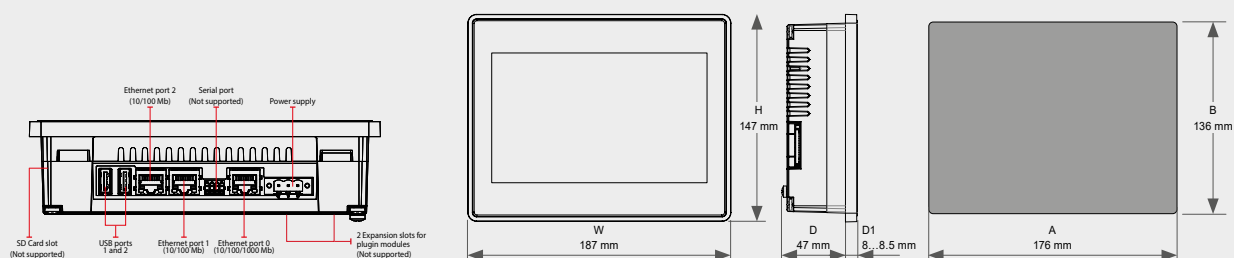



Technical Data	PCD7.D510CF1	PCD7.D515CF1	PCD7.D521CF1
	Capacitive (multi touch)		
Display size (inch)	10.1" TFT, 16:9, LED, 16 M	15,6" TFT, LED, 16 M	21,5" TFT, LED, 16 M
Operating system	Linux	Linux	Linux
Resolution (pixels)	1280 x 800, WXGA	1366 x 768, HD	1920 x 1080, Full HD
Brightness	500 cd/m ²	400 cd/m ²	300 cd/m ²
Touchscreen	True Glass projected Capacitive, Multi touch	True Glass projected Capacitive, Multi touch	True Glass projected Capacitive, Multi touch
USB Port	2x (Host v. 2.0, max. 500 mA)	2x (Host v. 2.0, max. 500 mA)	2x (Host v. 2.0, max. 500 mA)
CPU	i.MX8M Mini Quad ARM Cortex-A53	i.MX8M Mini Quad ARM Cortex-A53	i.MX8M Mini Quad ARM Cortex-A53
RAM	2 GB	2 GB	2 GB
Flash	4 GB	4 GB	4 GB
Power Supply	24 Vdc (10... 32 Vdc)	24 Vdc (10... 32 Vdc)	24 Vdc (10... 32 Vdc)
Current consumption	1.0 A max. at 24 Vdc	1.2 A max. at 24 Vdc	1.7 A max. at 24 Vdc
Operating temp.	-20...+60°C	-20...+60°C	-20...+60°C

Dimensions (W × H × D) and cut-out (A × B) mm

PCD7.D510CF1 | 10,1" HTML5 Web Panel, capacitive touch

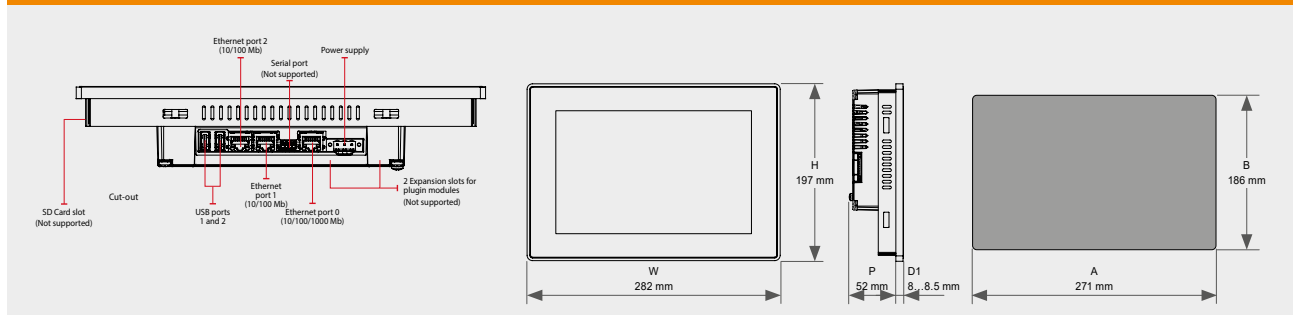

PCD7.D515CF1 | 15,6" HTML5 Web Panel, capacitive touch

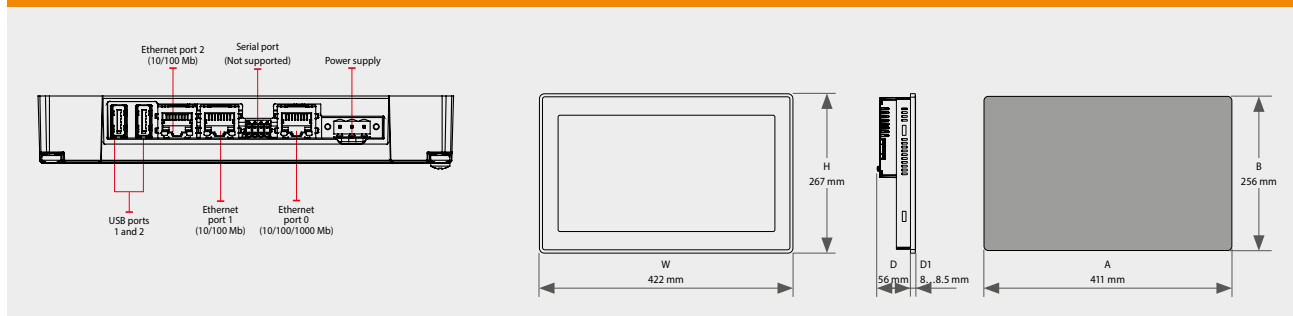

PCD7.D521CF1 | 21,5" HTML5 Web Panel, capacitive touch

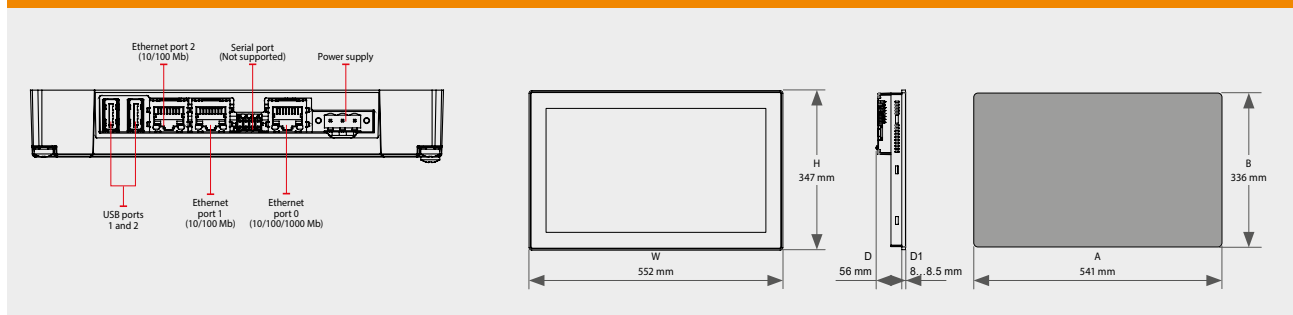

A3 Programmable and configurable room controllers

From room controllers with integrated, configurable applications to the Saia PG5 freely programmable room controller allowing flexible and individual room solutions, a range of room controller products with various communication protocols is available. Even without a bus connection, full, independent functionality is guaranteed.



3.1 PG5 freely programmable S-Bus/Modbus room controllers for flexible and individual room solutions

▶ 3.1.1 Overview and advantages of the PCD7.LRxx-P5 system	Page 102
▶ 3.1.2 Programming	104
▶ 3.1.3 Product overview	105
▶ 3.1.4 Connection examples	106
▶ 3.1.5 Accessories for PCD7.LRxx-P5	107
▶ 3.1.6 Project planning information	108

3.2 PCD7.LRxx BACnet room controllers can be configured and commissioned via an Android app

▶ 3.2.1 Overview and advantages of the PCD7.LRxx system	Page 109
▶ 3.2.2 Set-up information with RoomUp and integration with the PG5	110
▶ 3.2.3 Application overview	113
▶ 3.2.4 Product overview and wiring examples	114
▶ 3.2.5 PCD7.LRxx accessories	116

3.1 PG5 freely programmable S-Bus/ Modbus room controllers for flexible and individual room solutions



3.1.1 Overview and advantages of the PCD7.LRxx-P5 system

Flexibility thanks to free programming capability

The freely programmable PCD7.LRxx-P5 room controller offers a high level of flexibility for scalable HVAC, lighting and shading solutions, allowing individual applications to be created. The programming is done via the Saia PG5 Controls Suite where the room controller can be teamed with other Saia PCD products and operated together. This means that a single software tool can be used to meet different requirements, from room management to building management, for efficient engineering.



Geared to individual customer requirements

With the help of the new room controller, HVAC, lighting and shading solutions become freely programmable. As a result, individual, cross-discipline plans, aimed at for example optimising energy consumption, can be drawn up for state-of-the-art hotel, hospital and office concepts. In order to create a tailored solution geared to the needs of customers and buildings, additional sensors and modules can be integrated – from programmable DALI modules and motion sensors to hotel-card reading devices. This high level of flexibility also allows special room and user experiences like those that play a role in the room concepts of hotels.



Efficient engineering

Via a USB connection, the room controller can be programmed in the Saia PG5 Controls Suite. Because SBC automation stations are compatible with this software, building management and room control can be done on a joint platform. This simplifies the programming process and increases its efficiency. Additional software solutions or hardware is not required.



Advantages

- ▶ 2 × RS-485 interfaces for S-Bus or Modbus communication and option of I/O expansion with E-Line RIO modules
- ▶ Room and building management requirements can be jointly controlled and fulfilled via one software tool (PG5)
- ▶ Programmable DALI and expansion modules which can be used for lighting and shading can easily be integrated
- ▶ Battery and maintenance-free wireless EnOcean sensor integration
- ▶ Reliable products with straightforward installation and maintenance processes thanks to removable terminals
- ▶ Thanks to their form factor, they can be installed in an electrical sub-distribution system.

Easily retrofittable

Interfaces

Two interfaces that can be configured as S-Bus or Modbus allow connection to higher-level building automation control systems as well as the integration of digital room operating devices and expansion modules. As a result, the room controller can be combined with existing SBC E-Line RIO modules which can be used as an I/O expansion for HVAC, lighting or shading control. In addition, a Sylk bus interface allows the integration of corresponding room operating devices with integrated sensors.

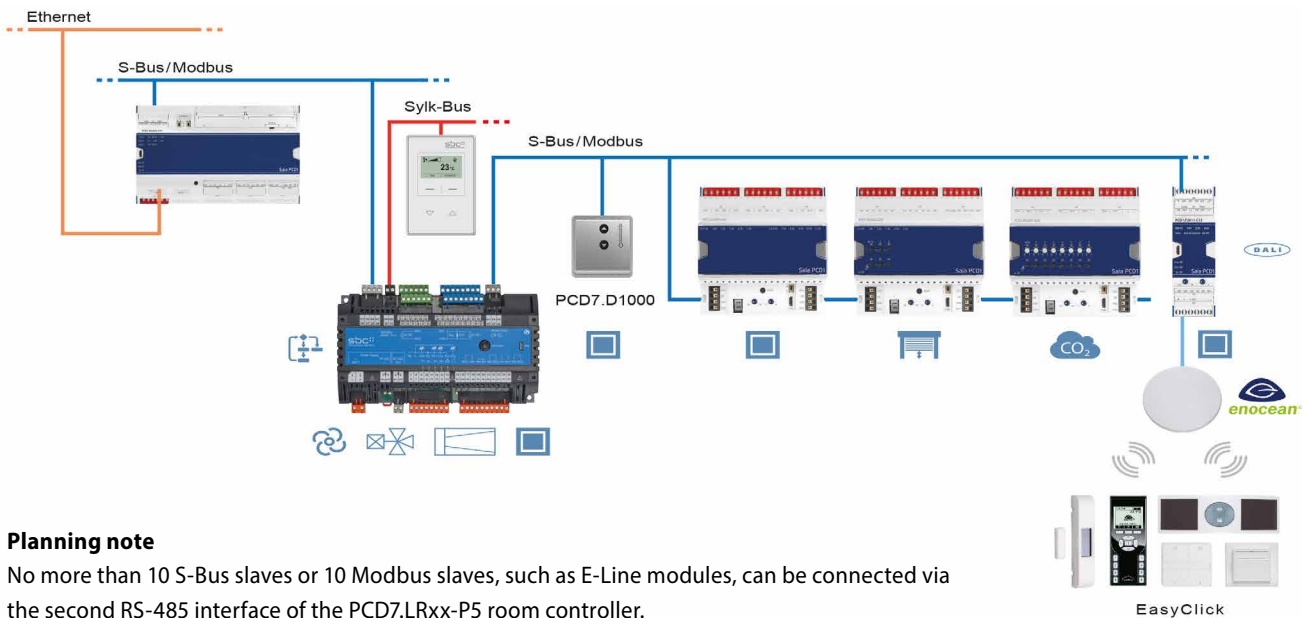

Planning note

No more than 10 S-Bus slaves or 10 Modbus slaves, such as E-Line modules, can be connected via the second RS-485 interface of the PCD7.LRxx-P5 room controller.

The following points must be observed in order to determine the feasible number of S-Bus/Modbus slaves:

- ▶ Bus cycle time → Use only for HVAC or, alternatively, lighting or shading
- ▶ Application program resource requirement
- ▶ The more E-Line modules there are connected to the second RS-485 interface of the PCD7.LRxx-P5, the less memory space there is for the application program. Further information and calculation aids can be found in the manual.

EnOcean

The RS-485 interface can also be used as an EnOcean gateway in order to connect a PEHA EnOcean antenna (PEHA ANT 450). As a result, battery and maintenance-free (PEHA Easyclick) EnOcean sensors (such as hotel-card switches, window contacts, movement sensors and operating devices) can be used.

In this system architecture, EnOcean switches should not be used for lighting or blinds via E-Line RIO modules connected to the primary RS-485 interface. If too many loads are connected to the RS-485 interface, the reaction time for a switching command could exceed 250 ms and would therefore be perceived as a disturbance.

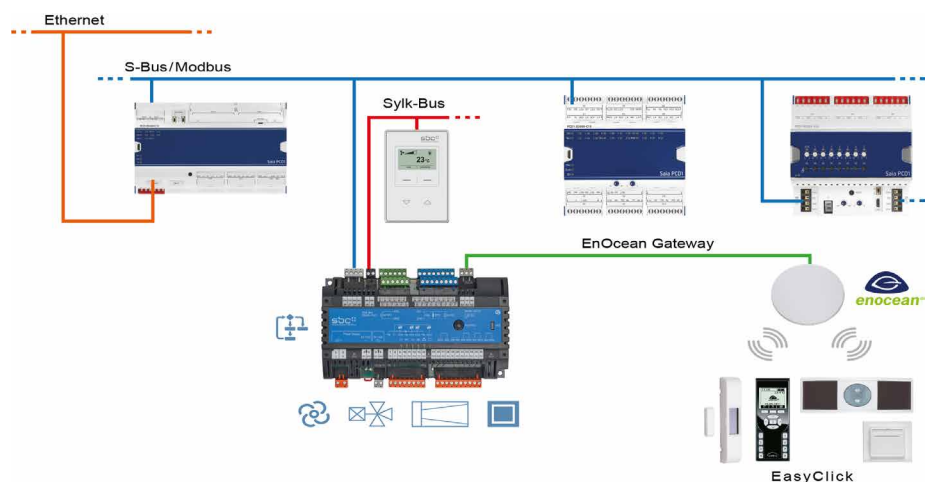

3.1.2 Programming

The modules are programmed with Saia PG5® using a master controller or directly via Micro-USB.

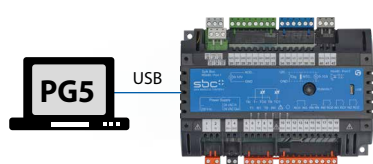

Programming directly via USB

PCD7.LRxx-P5 controllers have a Micro-USB port on the front of the module. Using a direct USB connection from the PC to the module, the user program can be loaded to the connected module or the firmware for the module can be updated. It is advisable to configure the S-Bus address prior to installation in the room controller to allow commissioning of the room controller and the downloading of the application program (and possibly a firmware update) via the RS-485 bus after installation.

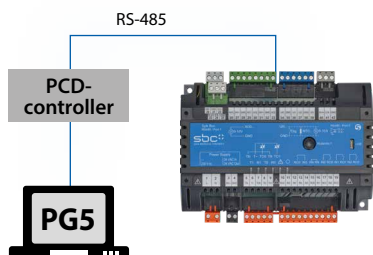

Programming using a master controller (PCDx.Mxxxx)

The master controller, which is connected to the freely programmable PCD7.LRxx-P5 room controller, uses the RS-485 bus (S-Bus) to load the user program or a firmware update for example to the corresponding modules. The master controller is used as a gateway in this case.

The modules are project-engineered with Saia PG5® using FBoxes or IL. A selection of FBoxes which make engineering easier is available for this purpose.

List of supported libraries:

PG5 standard FBox libraries

- ▶ Binary
- ▶ Blinker
- ▶ Block Control (no SB)
- ▶ Buffers
- ▶ Com.Text (not interpreted)
- ▶ Converter
- ▶ Counter
- ▶ DALI E-Line Driver (new)
- ▶ Data Block
- ▶ Data Buffer
- ▶ EIB Driver (partly)
- ▶ EnOcean (partly)
- ▶ Flip-Flop
- ▶ Floating Point (IEEE only)
- ▶ HVC (partly)
- ▶ Indirect
- ▶ Integer
- ▶ Ladder
- ▶ Move In/Out
- ▶ Modbus (E-Suite)
- ▶ Regulation (partly)
- ▶ Special, Sys Info (partly)
- ▶ Timer
- ▶ PHC

In addition to these libraries, a new library "E-Suite V2" is available for specific applications that can be implemented using the Saia PCD1 E-Line modules.

For electrical building services, for example: blind control, dimming of lighting etc.

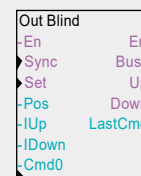
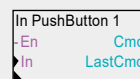
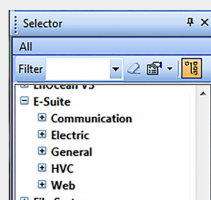

In order to be able to use the PCD7.LRxx-P5 controller with E-Line devices, the E-Line library V1.3 (or higher) must be installed in PG5. The required PCD, IRM and E-Line firmware versions are described in the FBox «Library Help».

Further information can be found in the V1.3 library help.

Program

Flash memory

Program blocks

COB	COB 0
XOB	XOB 10, 12, 13 and 16
PB/FB	100 with maximum hierarchy on 8 levels

Data types

ROM text/DB	50
-------------	----

Memory

Program memory	128 kB
----------------	--------

Media

Volatile memory (RAM) without battery backup

Data types

Registers	4000
Flag	4000
Timer / counter	400

Memory

Memory (RAM) for 50 texts / DB	10 kB
Memory (EEPROM) for parameter (media) backup	256 bytes
Cyclical synchronisation with PCD controller	Real time clock (RTC)

Compared to a PCDx.Mxxxx controller, not all functions are available. For example, these modules do not have an automation server.



Further information, including which FBoxes are supported can be found on our support page www.sbc-support.com.

3.1.3 Product overview

	Order number	Power supply	Analogue outputs	Universal inputs	Relays	Triacs (24/230 VAC)	Total I/Os	LED output	24 VAC outputs for field devices	Sylok	USB	2nd RS-485	Gold Cap 72 hours	Terminals
Large room controller 198 × 110 × 59 mm	PCD7.LRL2-P5	230 VAC	2	6	4	4	16	1	300 mA	Yes	Yes	Yes	Yes	All terminals removable
	PCD7.LRL4-P5	230 VAC	6	10	4	4	24	0	300 mA	Yes	Yes	Yes	Yes	
	PCD7.LRL5-P5	24 VAC	6	10	4	4	24	0	600 mA	Yes	Yes	Yes	Yes	
	IRM-RLC	Package including 10 large terminal covers												
Small room controller 162 × 110 × 59 mm	PCD7.LRS4-P5	230 VAC	4	4	4	2	14	0	300 mA	Yes	Yes	Yes	Yes	
	PCD7.LRS5-P5	24 VAC	4	4	4	2	14	0	600 mA	Yes	Yes	Yes	Yes	
	IRM-RSC	Package including 10 small terminal covers												

Controller example PCD7.LRL4-P5

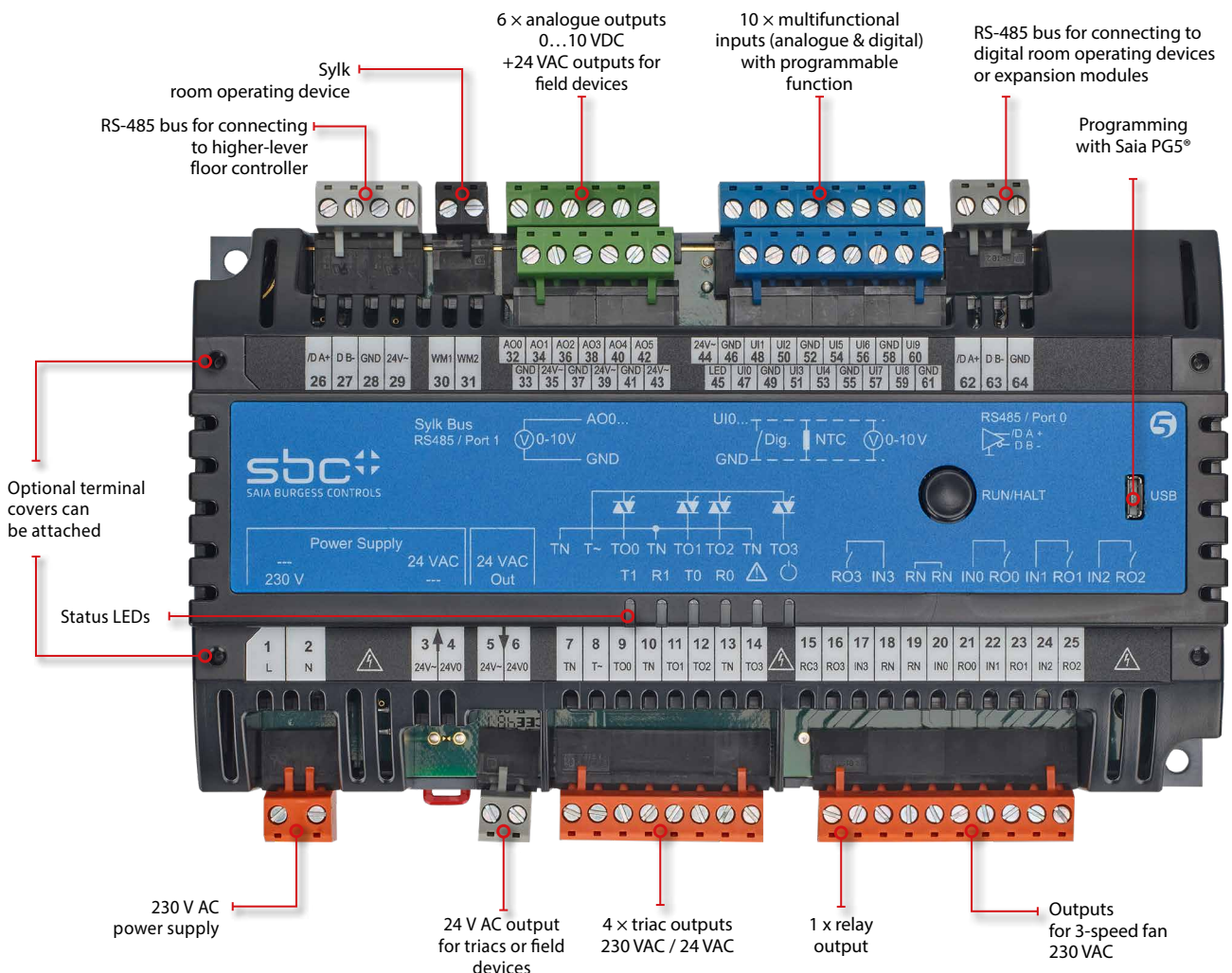

3.1.4 Connection examples

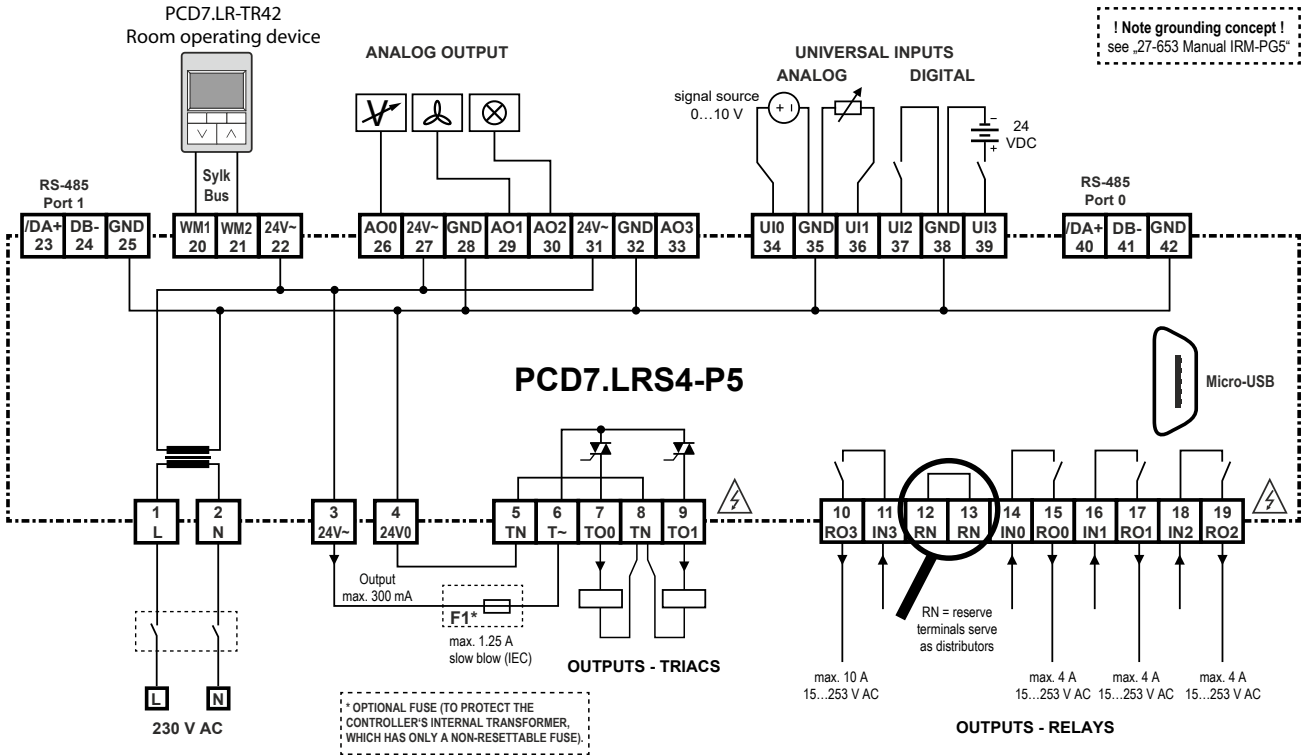

PCD7.LRS4-P5 wiring example

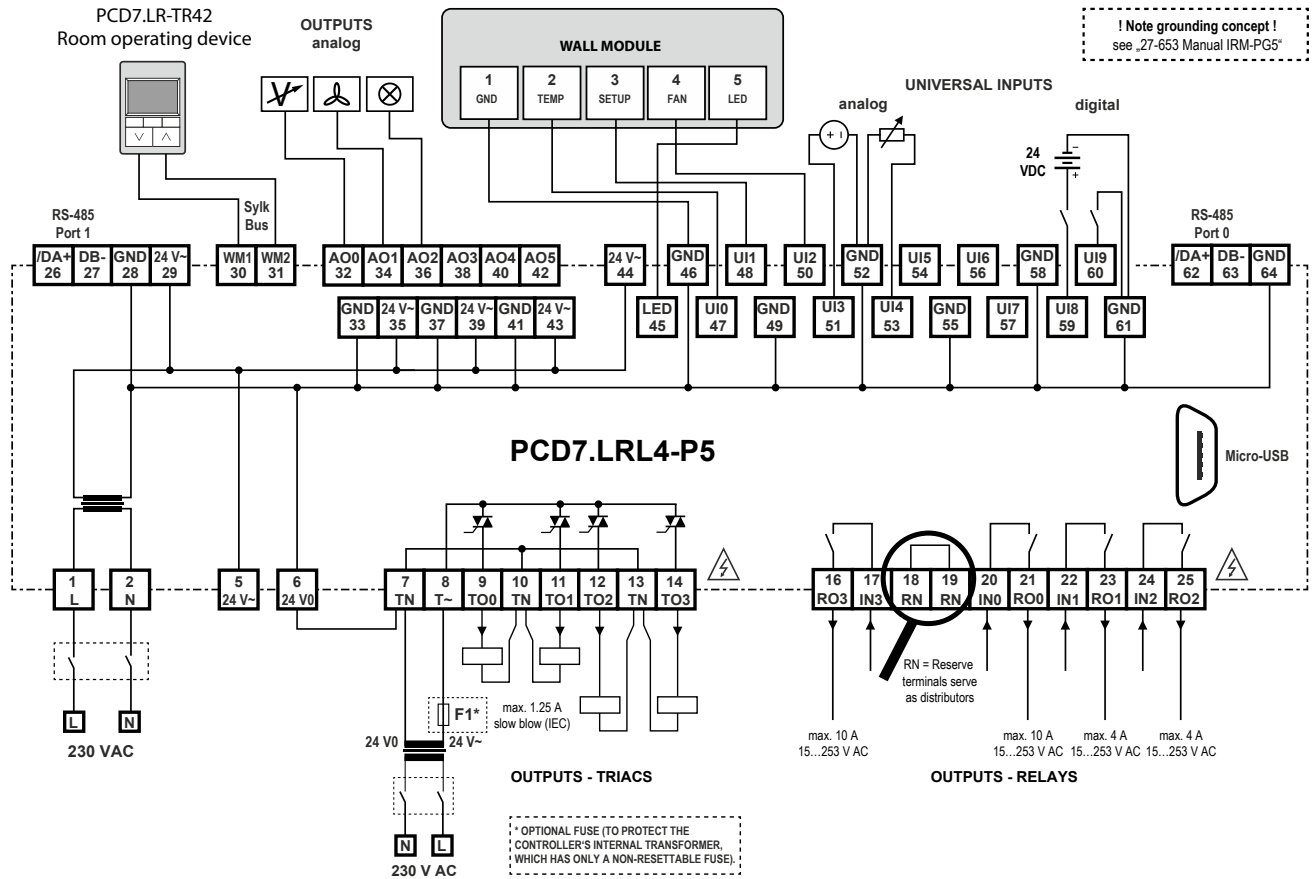

PCD7.LRL2-P5 wiring example

3.1.5 Accessories for PCD7.LRxx-P5

IRM-RSC/IRM-RLC

Terminal covers

Clip-on terminal covers (IP30 contact protection) for small or large controllers to prevent the user touching the 230 VAC terminals.

Optional for IP30

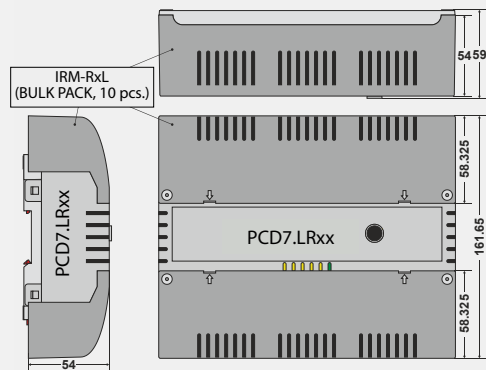

Compatible room operating devices

Sylk bus room operating devices

- ▶ Polarity-independent 2-wire bus with power and data transmission
- ▶ Types with integrated sensors for temperature, humidity and CO₂ sensor in one device
- ▶ Up to 4 room operating devices per PCD7.LRxx-P5 with a total cable length of up to 150 m

PCD7.LR-TR42

Room temperature sensor
+ setting option for setpoint,
presence and fan speed
+ LCD display
(+ humidity and CO₂ sensor)

Order number:
PCD7.LR-TR42
PCD7.LR-TR42-H
PCD7.LR-TR42-CO2
PCD7.LR-TR42-H-CO2



PCD7.LR-TR40

Room temperature sensor
(+ humidity and CO₂ sensor)
with Sylk bus connection
to the controller.

Order number:
PCD7.LR-TR40
PCD7.LR-TR40-H
PCD7.LR-TR40-CO2
PCD7.LR-TR40-H-CO2



PCD7.D1000

S-Bus / Modbus room operating device for room temperature measurement, setpoint offset setting

- ▶ Design in accordance with PEHA Dialog Aluminium
- ▶ Room temperature sensor 0...40 °C
- ▶ Setpoint offset control ± 3 K in 0.5 K steps
- ▶ 7 LEDs to indicate the setpoint offset
- ▶ 2 plug-in RJ9 connections for *Daisy Chain* and up to 6 room operating devices.

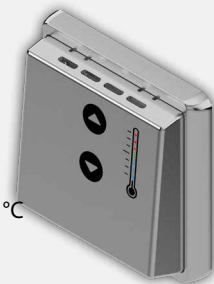

3.1.6 Project planning information

Bus terminating resistor and bus cable for serial S-Net (S-Bus/RS-485)

S-Bus cables must be installed as a line. Stub lines are not permitted and both ends of the cable must be terminated with a resistor (approx. 120 Ω) between the D and /D cables. The best signal quality is achieved using an active bus connection with a resistor to +5V and GND.

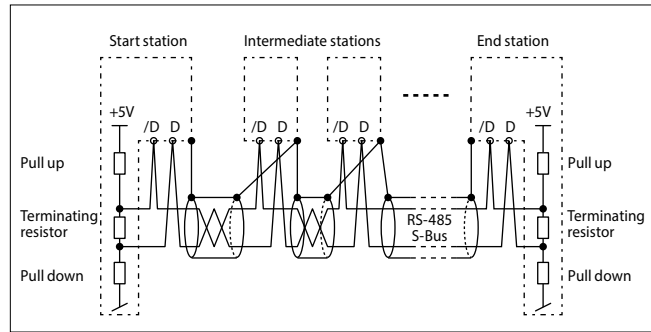

Schematic illustration of an S-Bus/ RS-485 bus



An external PCD7.T161/2 termination box can be used as bus termination resistor.

Bus cable: A 2-strand twisted and shielded bus cable with cable strands of at least 0.5 mm² must be used.

Bus shielding: The shielding of each S-Bus segment may only be connected with the electrical system ground at one point. To avoid problems with large potential differences between the room controllers, the shielding of the S-Bus cable should be connected with the GND of the room controller.

For more information, see S-Bus manual 26-739 (at www.sbc-support.com).

Types of use and modes of operation

The function of the room controller is based on various types of use or modes of operation.

Each of the selectable modes of operation can be assigned different control parameters.

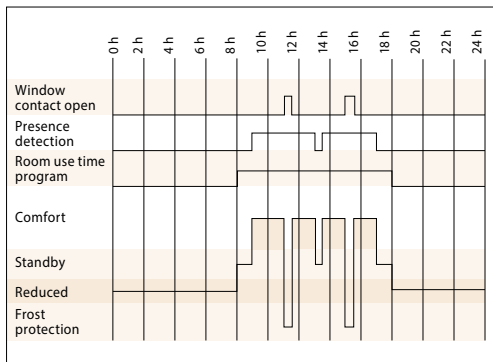

Example: Operating mode switchover

Safety mode/Frost protection

No heating or cooling energy is fed into the room. This state is desirable if a window is open. The room controller keeps the room temperature above the preset frost line of 8° C.



Non-use/reduced

Reduced operation mode which is used when the room is unoccupied for long periods. The specified setpoint value offset is not active in this operation mode.



Standby

The room is prepared for use but no presence has yet been registered in the room. As long as the room is not classified as occupied by the presence function, the room controller maintains the room temperature within the specified limits at the standby temperature.



Use/comfort

The room is used and should be brought to the comfort temperature.

This state can be reached by pressing the presence button, reacting to an external presence detector or a parameter on the network side.



Compact room controller installation information

- ▶ Do not install the compact room controller near windows or doors due to potential draughts. The recommended position is on an opposite wall at a height of approx. 1.5 m.
- ▶ Do not install it near to heat sources such as heating systems, fridges, lights, etc. Avoid direct sunlight or direct light from bright lighting.
- ▶ Do not locate the compact room controller in draughts produced by air conditioning and ventilation systems.

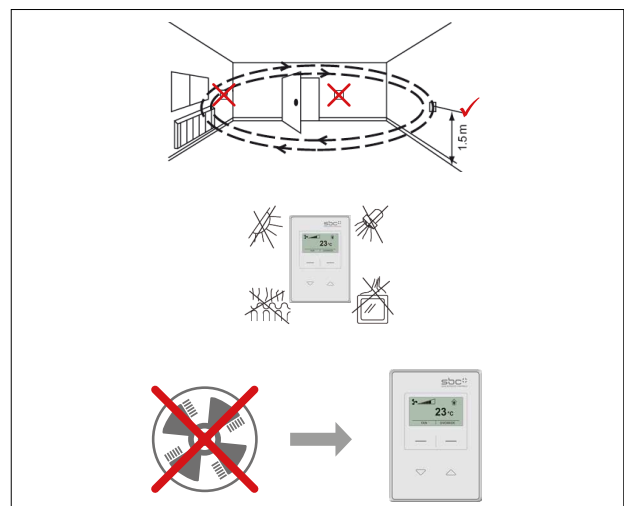

3.2 PCD7.LRxx BACnet room controllers can be configured and commissioned via an Android app

3.2.1 Overview and advantages of the PCD7.LRxx system

BTL®-listed PCD7.LRxx BACnet room controller

A new, easy way to commission room applications – via an Android device and the RoomUp app

The new BACnet room controller in the PCD7.LRxx series allows efficient, quick commissioning and testing of the connected actuators and sensors.

The room controllers have universal inputs that can be configured for a variety of functions, and their form factors also allow them to be installed in electrical sub-distribution systems. They also have a Sylk bus interface for connecting digital room operating devices.

The following applications can be configured:

- ▶ Fan convectors, fans with 1–3 speeds or fans with a variable speed
- ▶ Inlet air flap control with combined air quality monitoring and temperature control
- ▶ Cooled ceiling
- ▶ Under-floor heating
- ▶ Radiator heating
- ▶ A combination of the aforementioned applications

Advantages

No programming needed

Applications can be created quickly and easily because the controller comes supplied with pre-installed applications which can be configured via the app.

Quick installation of applications across projects – as soon as an individual room is configured, the application configuration can be extended to other rooms via the RoomUp app ("template concept").

Easier installation

In order to cater for various installation requirements, the controller can be mounted universally on DIN top hat rails, in small installation housings and on walls (including optional terminal covers).

Triac outputs can be controlled with 24 VAC or 230 VAC.

Easier commissioning

The solutions allow very efficient "commissioning by one person" via the "RoomUp" app with quick, straightforward and reliable test procedures on location thanks to the "RoomUp" app's guided testing and reporting.

Automatic MS/TP-MAC addressing by scanning a barcode.

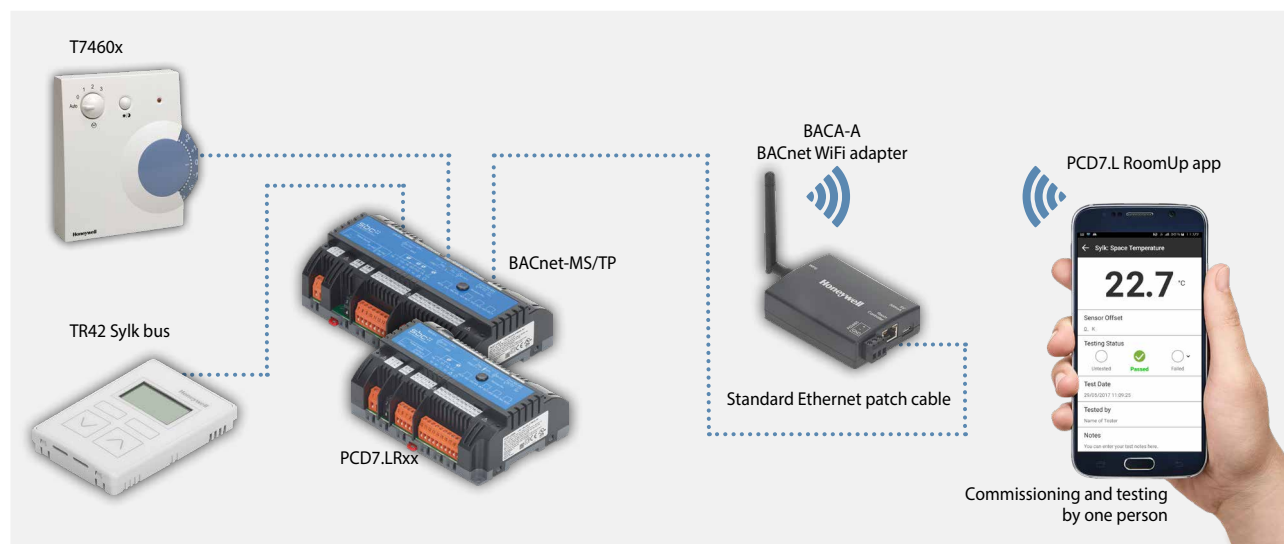

3.2.2 Set-up information with RoomUp and integration with the PG5

RoomUp

A unique commissioning experience

RoomUp is used to configure, commission and test the application.

RoomUp offers an entirely new way of commissioning room systems and carrying out final tests:

- ▶ Quick and easy commissioning by one person via a smartphone or tablet
- ▶ Easier, reliable tests on location thanks to the wireless connection with guided testing and integrated reporting
- ▶ Efficient, automatic device addressing
- ▶ Wireless communication allows commissioning before bus installation is complete

A template concept helps the user to determine the standard room types used in the building (templates). The template is used on all controllers for the relevant room type. A change to the template can easily be applied to all controllers with the same template.

The RoomUp app can be downloaded from the Google Play Store.

In order to activate the downloaded RoomUp app, a RoomUp licensing key with the order number PCD7.L-ROOMUP is required.

RoomUp is an Android app for smartphones and tablets running Android 5.0 or higher.



See for yourself the advantages.

RoomUp video
<http://sbc.do/Tc2kPraY>

GET IT ON



Addressing

The person commissioning the system does not need to set addresses via address switches. PCD7.LRxx automatically uses an unused BACnet address (automatic MS/TP-MAC addressing). Assignment to a specific room is easily possible via the service button or by scanning the barcode label. 1 barcode label is placed on the controller and 1 barcode label can be removed and stuck to the layout.

Recommended system size with RoomUp

- ▶ Buildings can be analysed on the basis of the layout in order to select suitable divisions with system controllers
- ▶ The project is subdivided into a number of BACnet MS/TP segments with a maximum of 30 devices per segment
- ▶ Large systems should be subdivided into a number of RoomUp projects with 300 devices per project (maximum permitted size)
- ▶ A RoomUp project should be commissioned by one person

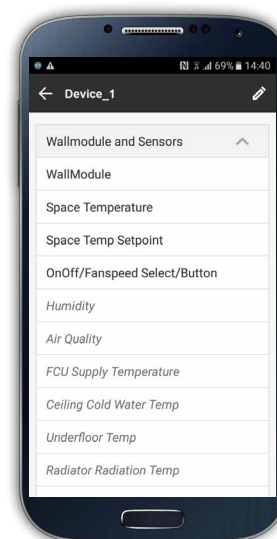
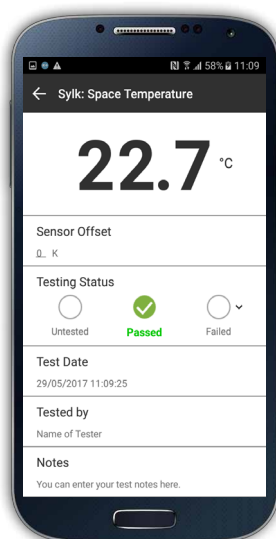
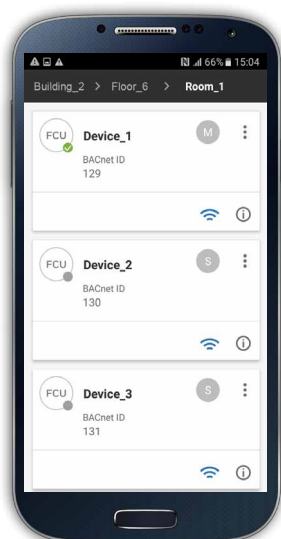
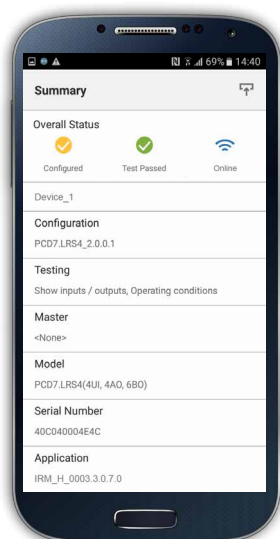

Wiring and device testing as well as an automatic test report for the project handover

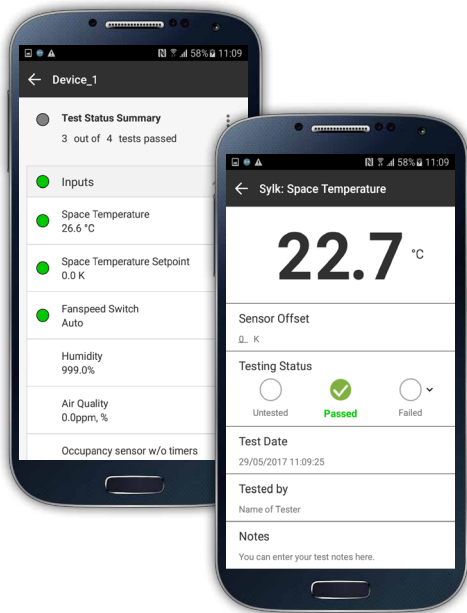

I/O report

Port	Signal	Comment
3	24 V	24 VAC supply inp./outp.
4	24 V0	24 VAC zero supply inp./outp.
5	TN	TN
6	T	T
7	TO1	RCU cooling
8	TN	Triacs N

Port	Signal	Comment
9	TO2	FCU heating
10	RO4	
11	IN4	Relay 4 L in
12	RN	Line N switched on/off
13	RN	Line N switched on/off
14	IN1	Relay 1 L in
15	RO1	1-speed fan
16	IN2	Relay 2 L in

Test report

Connection point type	Connection name	Data point name	Last value	Units	Sensor offset	Test status	Tested by	Test date	Re-remarks	Error message
Analogue input	Sylk	RmTemp	26.85674	°C		Passed	Johann Klempner	26.07.2016 16:24:48		
Analogue input	Sylk	RmTempSp	2.5	°C		Passed	Johann Klempner	26.07.2016 16:24:48		
Multi-level value	Sylk	WMFanManSwCmd	3				Johann Klempner	26.07.2016 16:24:48		
Analogue output	AOPWMTO1	FCUClgCtl	100	%		Passed	Johann Klempner	26.07.2016 16:24:48		
Analogue output	AOPWMTO2	FCUHTgCtl	0	%		Passed	Johann Klempner	26.07.2016 16:24:48		
Multi-level value		FCUFanStgCmd	2			Passed	Johann Klempner	26.07.2016 16:24:48		

If necessary, the reports generated can be sent straight to an e-mail address.

Typical system architecture

For BACnet MS/TP communication, the PCD requires the following modules (see chapter B2.6.1):

- ▶ BACnet MS/TP communication interface: PCD3.F215 or PCD2.F2150 (and an additional PCD7.F110S for a second BACnet MS/TP interface)
- ▶ BACnet optional module for firmware expansion: PCD7.R562 or PCD3.R562

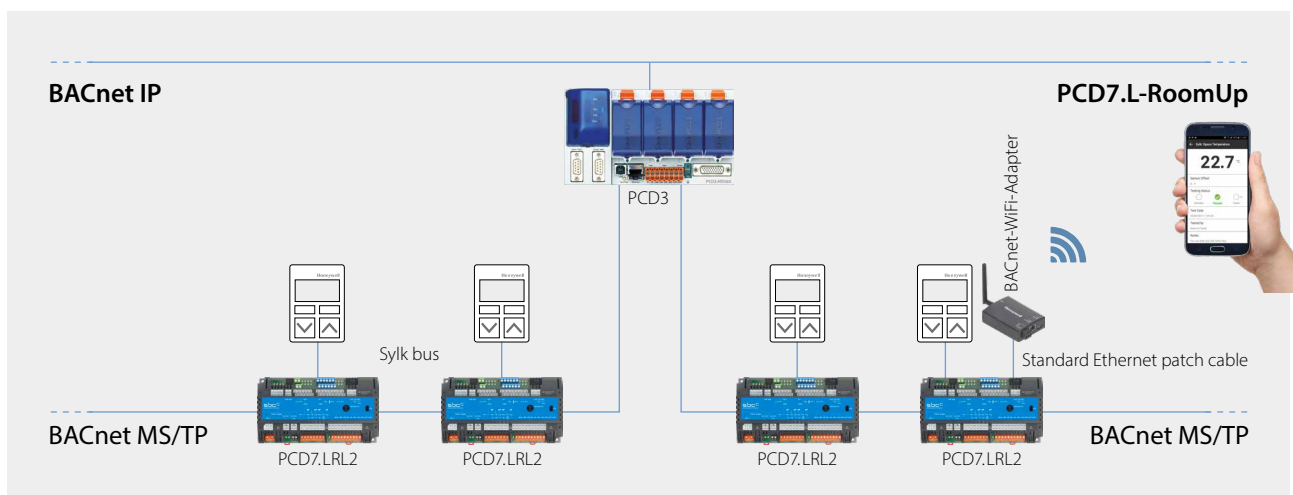

The following PCDs are compatible with the PCD7.LRxx controller:

PCD1

- ▶ PCD1.M2160
- ▶ PCD1.M2220-C15

PCD2

- ▶ PCD2.M4160, PCD2.M4560

PCD3

- ▶ PCD3.M3160, PCD3.M3360, PCD3.M5360
- ▶ PCD3.M5560
- ▶ PCD3.M6860, PCD3.M6880

Restrictions and performance

A maximum of 30 PCD7.LRxx controllers can be connected to an MS/TP line. Per PCD, up to 4 MS/TP lines can be used to connect the PCD7.LRxx controllers.

Performance of PCD3.M5560 at a communication speed of 38.4 kbits/s:

- ▶ Communication cycle time: With 30 PCD7.LRxx controllers on an MS/TP line, the token cycle time is 1.64 seconds
- ▶ With 30 PCD7.LRxx controllers, the maximum change of value per minute (COV/min) is 1,100 COV/min (this maximum value depends on the limits of the MS/TP network and the communication cycle time)

Importing application BACnet objects using the .ede file in PG5

Version PG5.2.2.200 or higher must be used. This version includes the BACnet Stack Rev. 14, the automatic assignment and creation of symbols and the BACShark tool for generating an .ede file.

Creating a BACnet configurator page

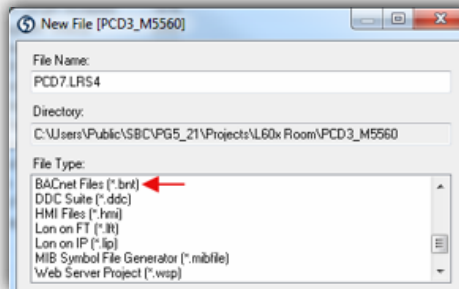

Importing the .ede file created by BACShark or BACeye

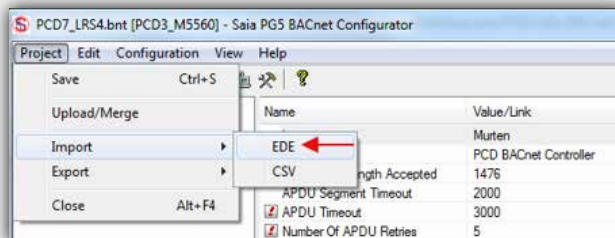

You can select the properties which are automatically assigned to flags and registered.

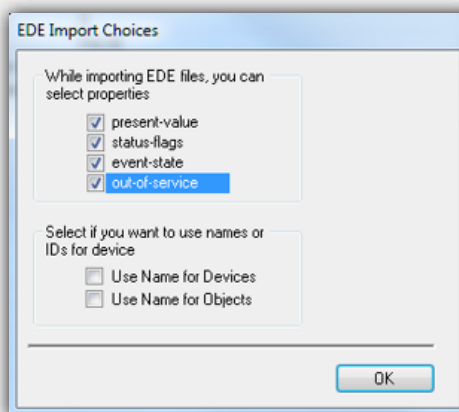

Multiple .ede files to be imported together into the BACnet configurator can be selected. This automatically creates the global symbols for all BACnet objects in the "BAC" folder with the following structure: BAC.Device Name.Object Name

3.2.3 Application overview

Configurable application

Fan convector	Ceiling	Inlet air	Radiator	Under-floor heating
Device configurations				
Cooling the coolant	Cooling	Cooling	Heating	Heating
DX cooling	Heating	Inlet air flap		
Hot water heating				
Electric heating				
2-pipe switching or 4-pipe system	2-pipe switching, 4-pipe system or 6-way MID valve			
Control strategy modes				
Room temperature control	Room temperature control	Room temperature control	Room temperature control	Room temperature control
Cascade temperature control		Room temperature control with cooling with lower limit value	Room temperature control with heating with lower limit value	Room temperature control with heating with lower limit value
Room temperature control with lower limit values for heating and cooling		Air quality and cooling control (optionally with cooling with lower limit value)		
Fan with 1, 2 or 3 speeds				
Fan with variable speed		Air quality monitoring only		

Straightforward system-wide application installation

After configuring an individual room, the application configuration can be extended to other rooms via the RoomUp app ("template concept"). This "template concept" also allows an automatic adjustment of the application configuration for a room in any room which is assigned the same template. This saves significant amounts of time when planning, especially in the case of projects where many rooms/zones are similar and the same application is used. Via master/slave configurations, applications can easily be adapted to changes in room design over the life of the building.

The following diagram provides an overview of the applications supported. Functions can be added by clicking on symbols.

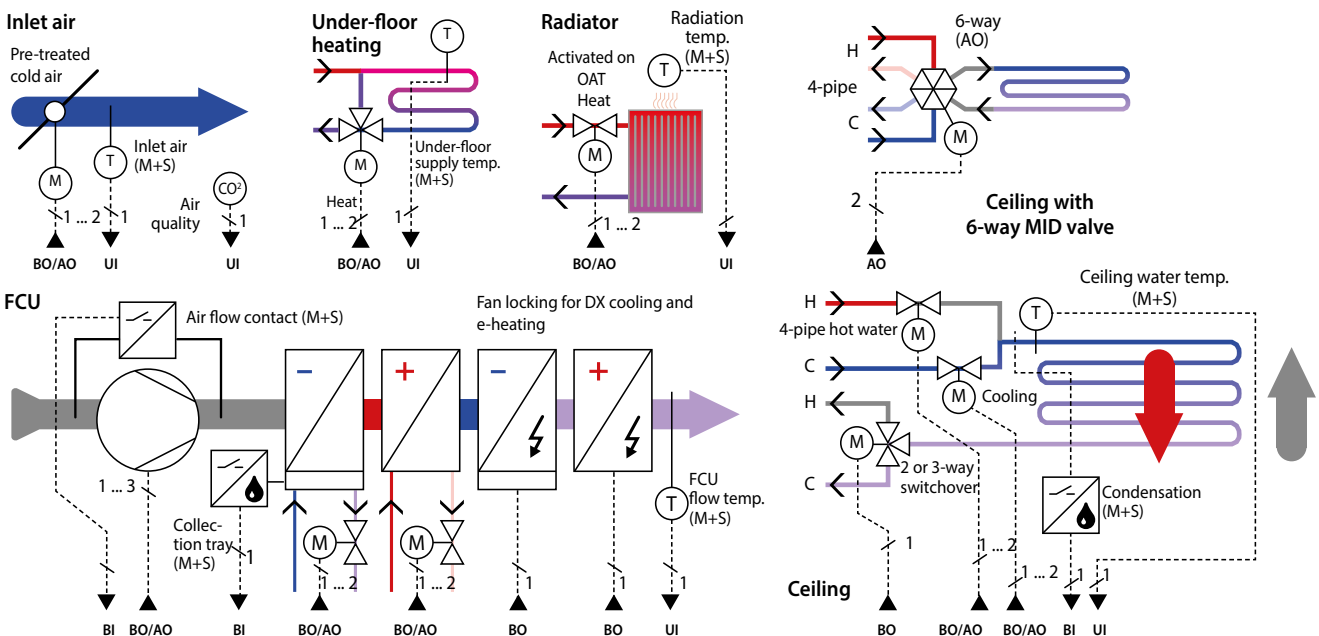

3.2.4 Product overview and wiring examples

PCD7.LRxx system overview

	Order number	Power supply	Analogue outputs	Universal inputs	Relays	Triacs (24 V or 230 V)	Total I/Os	LED output	24 V AC for field devices
Large controller 198 × 110 × 59 mm	PCD7.LRL2	230 V AC	2	6	4	4	16	1	300 mA
	IRM-RLC	Package including 10 large terminal covers							
Small controller 162 × 110 × 59 mm)	PCD7.LRS4	230 V AC	4	4	4	2	14	0	300 mA
	PCD7.LRS5	24 V AC	4	4	4	2	14	0	600 mA
	IRM-RSC	Package including 10 small terminal covers							
Commissioning	BACA-A	Wi-Fi adapter and RJ45 cable							
	PCD7.L-RoomUp	SBC RoomUp licence							
	RoomUp	Smartphone app for PCD7.LRxx commissioning requires Android 5.0 or higher. The app is available via the Play Store							
Room operating devices	Syk bus: TR40, TR40-CO2 without display / TR42, TR42-CO2 with display								
	Hard-wired to the controller's I/Os: T7460x								

Dimensions:



PCD7.LRL2 (large housing):
W × L × H = 110 × 198 × 59 mm



PCD7.LRSx (small housing):
W × L × H = 110 × 162 × 59 mm



PCD7.LRS4
+2 × IRM-RSC



PCD7.LRS5
+2 × IRM-RSC



PCD7.LRL2
+2 × IRM-RLC

PCD7.LRxx with
optional
covers
(covers are supplied
in sets of 10)

Controller example: PCD7.LRS4

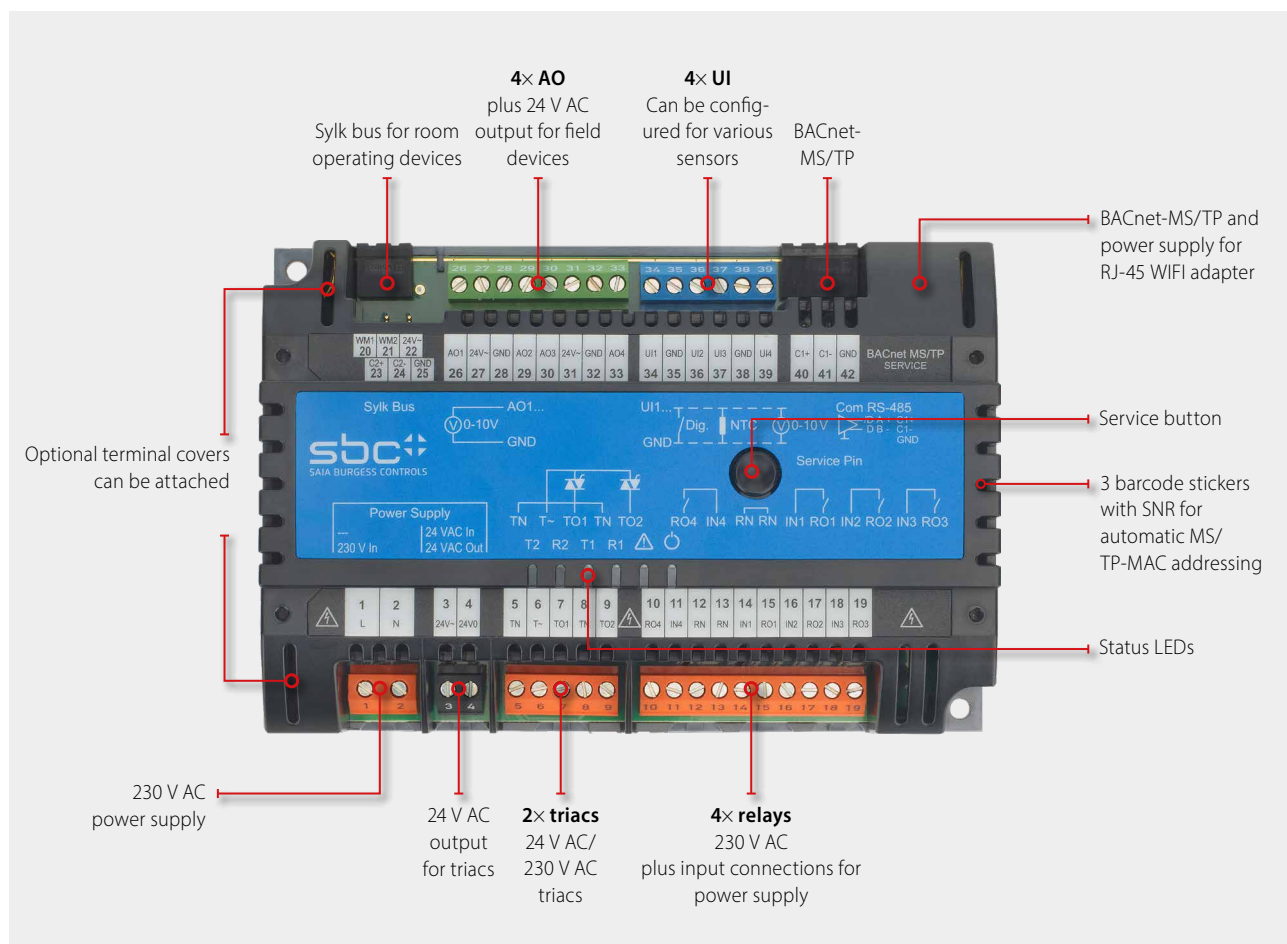

Automation stations

1

Operation and monitoring

2

Room controllers

3

Wiring example for a PCD7.LRS4 controller

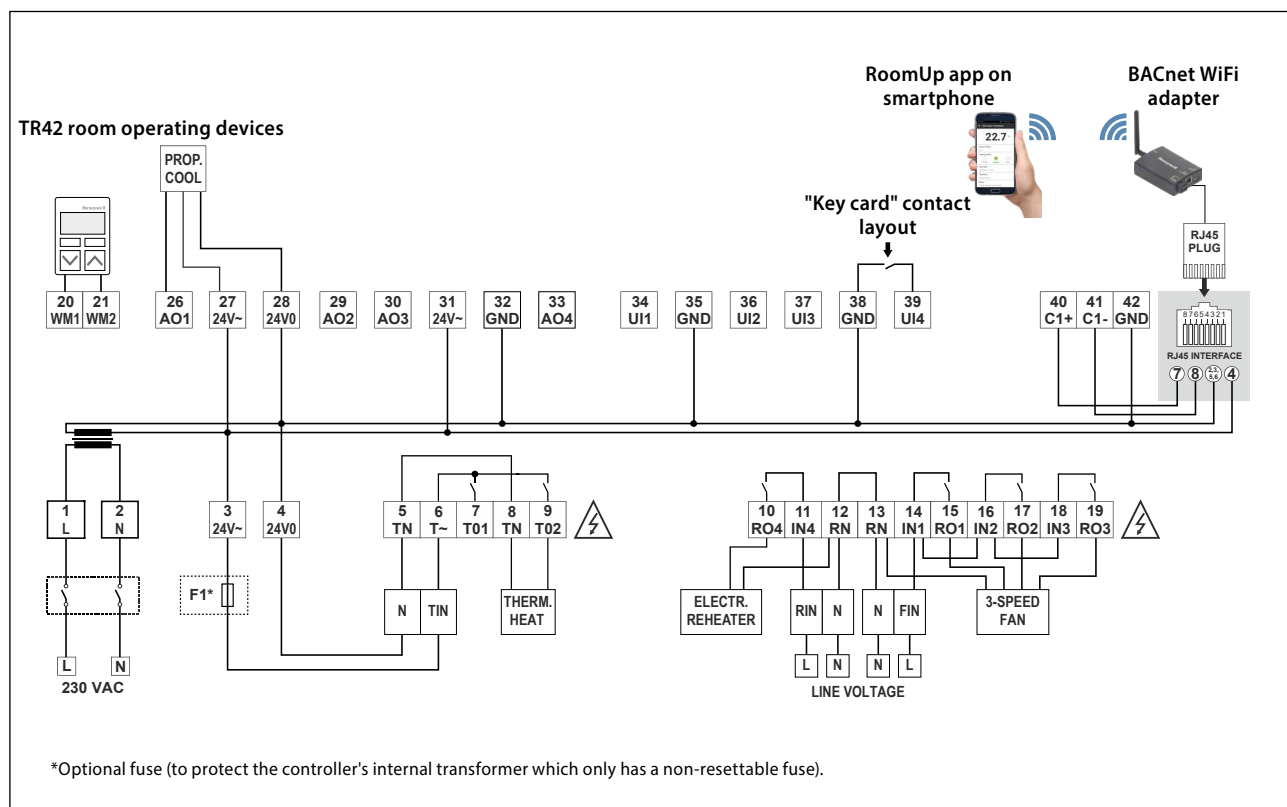

Consumer data acquisition

4

Switch cabinet components

5

3.2.5 PCD7.LRxx accessories

IRM-RSC/IRM-RLC

Terminal covers

Clip-on terminal covers (IP30 contact protection) for small or large controllers to prevent the user touching the 230 VAC terminals.

Optional for IP30

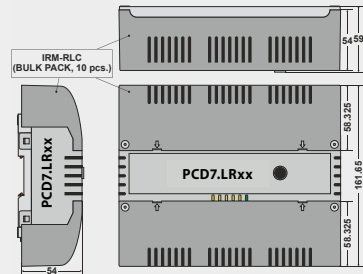

BACA-A

Mobile BACnet MS/TP access point for RoomUp

Straightforward one-cable connection to the PCD7.LRxx controller

Additional option for connecting MS/TP cables and power supply via mini-USB

Wi-Fi-protected setup (WPS) for quick device connection

Web interface for device configuration



Compatible room operating devices

Sylk bus room operating devices

- Types with integrated sensors for temperature, humidity and CO2 sensor in one device

PCD7.LR-TR42

Room temperature sensor
+ setting option for setpoint,
presence and fan speed
+ LCD display
(+ humidity and CO2 sensor)

Order number:

PCD7.LR-TR42
PCD7.LR-TR42-H
PCD7.LR-TR42-CO2
PCD7.LR-TR42-H-CO2



PCD7.LR-TR40

Room temperature sensor
(+ humidity and CO2 sensor)
with Sylk bus connection
to the controller.

Order number:

PCD7.LR-TR40
PCD7.LR-TR40-H
PCD7.LR-TR40-CO2
PCD7.LR-TR40-H-CO2



Wired room operating devices from Honeywell

T7460x

Room temperature sensor
+ setpoint setter
+ occupancy button
+ fan speed adjuster

Order number:

T7460A1001 T7460D1005
T7460B1009 T7460F1000
T7460C1007



Room operating devices with connectors for connecting to the controller inputs.

A4 Collect, visualise and process consumption data

With the field devices of the S-Monitoring system, electrical energy is measured and signals from water, gas and heating meters are captured. The S-Monitoring application processes and visualises data automatically in a clearly arranged manner. Thus, the system generates a high degree of transparency regarding resource consumption. This functions from just a few measuring points up to thousands of measuring points in distributed properties.



S Monitoring

4.1 System overview

S-Monitoring makes it easy to manage energy and consumption. Ready-to-use directly from the packaging and it does not require any complicated configuration and programming. It can also be customised to meet your specific requirements – it is a system, that grows with you.



Page 118

4.2 Energy meters ALD, ALE and AWD

Saia Burgess Controls, is a European market leader in bus-capable energy meters for sub metering of electrical energy data: for machines, plants and building components.



120

4.3 S-Monitoring application

S-Monitoring is an integral part of the COSinus operating system and is integrated into all controls with the extension xx60 and the pWeb panels. It enables consumption data to be acquired automatically without time-consuming programming and saves it on the file system.



128

4.4 Saia PCD® E-Controller

The E-Controller with S-Monitoring function combines data capture, visualisation and logging of energy consumption in one compact device. Users can use the inputs and outputs to intervene in processes for regulation.



132

4.5 Saia PCD® S0 pulse counter

Collect, convert and transmit S0 pulses: With the PCD7.H104 pulse counter modules, non-bus-capable meters can also be integrated into an S-Monitoring system.



136

4.1 System overview



S-Monitoring makes it easy to manage energy and consumption. Ready-to-use directly from the packaging and it does not require any complicated configuration and programming. It can also be customised to meet your specific requirements – it is a system, that grows with you.

The system includes devices and components for capturing, recording and displaying consumption. With the Web Panel installed on-site, analysis can be carried out on the office PC or remotely via the Internet web browser. The open IT interfaces make it possible to connect the system to a superordinate data management system at any time. There is no need to replace the hardware to do this.

Example of external software

ftp SNMP http @

Ready for use immediately on delivery

Continuous optimisation in calculable steps:

Sustainable resource management means a continuous gain in knowledge in a changing environment. The optimum solution is different for each business, and must be developed with careful consideration. S-Monitoring supports a cautious approach in small, controllable steps and starts with the basics. It is possible to start resource management without external help using cost-effective, easy-to-install components. Even after just a few days, initial results are set and point the way for further optimisation steps. The investment risk is negligible and remains limited to each individual development step.

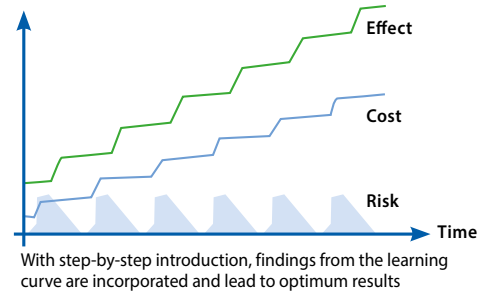
**Remote visualisation and evaluation of consumption**

- ▶ **Reading and operating via LAN/Internet with web browser and mobile devices**
- ▶ **Integration into other systems via standard interfaces**

If the Web Panel and controller are connected to a network (LAN), meter readings and operation can be carried out using commercially available PCs with standard browsers. Special software installations are not required and apps are available for mobile devices. This can even be carried out across locations if there is an Internet connection.

Databases, energy management software or control systems can be connected via standard interfaces (e.g. FTP, CGI, HTTP, etc.).

Logging consumption

- ▶ **Historical consumption readings (Day / Week / Month / Year)**
- ▶ **Logging in Excel-readable files**

The Web Panel and controllers read consumption values of the connected meters and display them in the form of a web visualisation. This can be called up either directly on the Web Panel or via the controller's web server with a web browser. Consumption and costs can be called up in meaningful diagrams via an intuitive user interface. In addition, the Web Panel and controllers record captured values in Excel-readable CSV files, which can be easily transferred to a PC via FTP. The function can be activated on any new controller.

Record consumption

- ▶ **Wide range of single and 3-phase energy meters and network analyzers**
- ▶ **S0 interface for the integration of commercially available meters for gas, water, oil, etc.**

Saia PCD energy meters and network analyzers follow established installation technology and are suitable for DIN rails of commercially available distribution boxes. Integrated into a bus system covering a distance of up to 1 km, the measured values are transmitted to the Web Panel and controllers for the purpose of analysis and logging.

Via pulse counters with an interface, commercial available meters with S0 output can be connected to the bus system.

4.2 Energy meters ALD, ALE and AWD

small, robust, reliable and accurate

The very compact design makes the SBC energy meters ideally suited to accommodate a large number of measuring instruments in the smallest space. The small size means the meters can also be fitted in existing switch cabinets without having to install new switch cabinets. The robust design has certainly proven itself under tough industrial conditions. The design of the energy meters is specifically designed for such applications, as is shown by a high level of reliability and durability. The display shows energy, current, voltage and active output.



Many energy meters in the smallest space ►

Single-phase Saia PCD® energy meters

Interface	Single-phase	
	Direct measurement 0.25...32 A	
	Unidirectional	Bidirectional
M-Bus	ALD1D5FM00A3A00	-
Modbus	ALD1D5FD00A3A00	ALD1B5FD00A3A00
S Bus	ALD1D5FS00A3A00	ALD1B5FS00A3A00
S0 interface	ALD1D5F10KA3A00	-

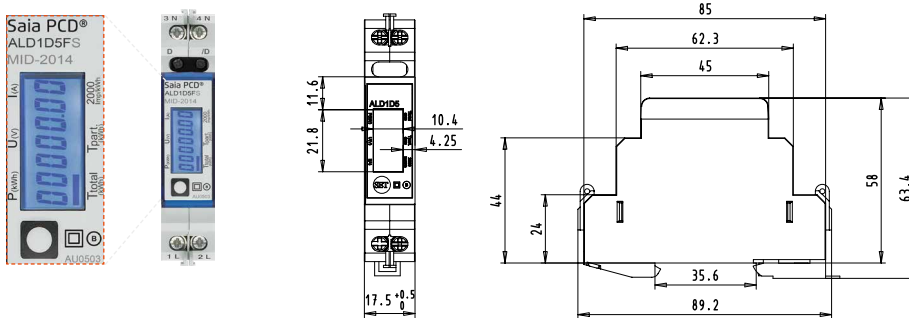

3-phase Saia PCD® energy meters

Interface	3-phase			
	Direct measurement 0.5...65 A		Converter connection up to 1500:5 A	
	Unidirectional	Bidirectional	Unidirectional	Bidirectional
M-Bus	ALE3D5FM10C3A00	ALE3B5FM00C3A00	AWD3D5WM00C3A00	-
Modbus	ALE3D5FD10C3A00	ALE3B5FD00C3A00	AWD3D5WD00C3A00	-
S Bus	ALE3D5FS10C3A00	ALE3B5FS00C3A00	AWD3D5WS00C3A00	AWD3B5WS00C3A00
S0 interface	ALE3D5F11KC3A00	ALE3B5F10KC3A00	AWD3D5W10MC3A00	AWD3B5W10MC3A00

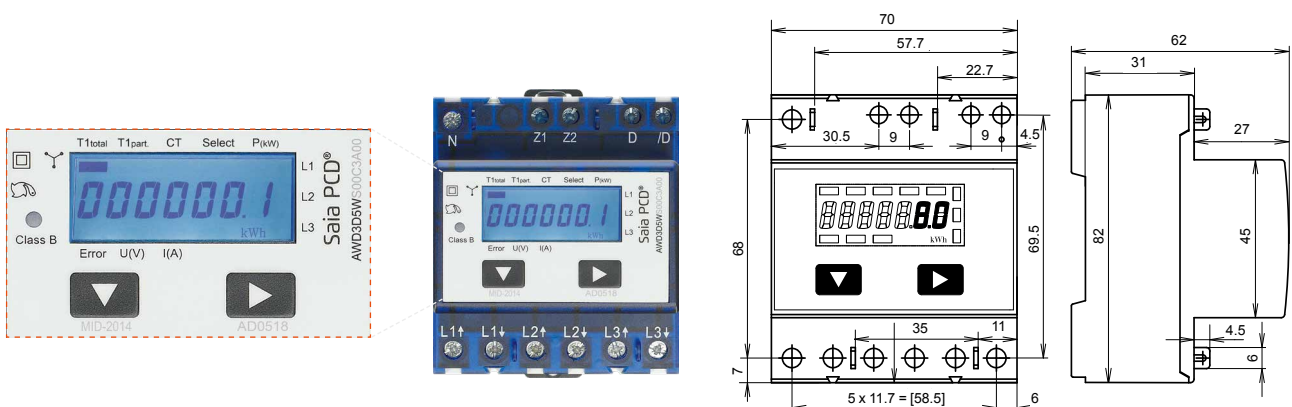

4.2.1 General information on energy meters

Reliable directly from the factory. The design and production of energy meters are such that the meters also exhibit high levels of reliability and durability even under extreme industrial conditions. The high quality standards of the production site guarantee high accuracy and enable the production of MID-approved energy meters, which have a guaranteed accuracy immediately following delivery and for their entire calibration period. This approval means that the measured values are considered totally accurate and can be used throughout Europe for billing purposes.



▲ Energy meters in tough industrial environment

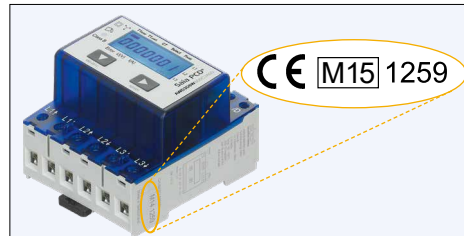

▲ Marking on an MID meter



▲ Production cell for energy meters

Meters for converter connection

The use of current converters makes costly shutdowns of entire machines for meter installation a thing of the past. The replacement of an energy meter or current converter while the system is running is possible with the consistent use of flap current converters, since the faulty parts can be replaced easily without disconnecting the entire system from the power supply.

Available converter ratios in Saia PCD® energy meters

Three-phase energy meters – secondary current 5 A			
5:5	50:5	100:5	150:5
200:5	250:5	300:5	400:5
500:5	600:5	750:5	1000:5
1250:5	1500:5	---	---



▲ Current converter in switch cabinet

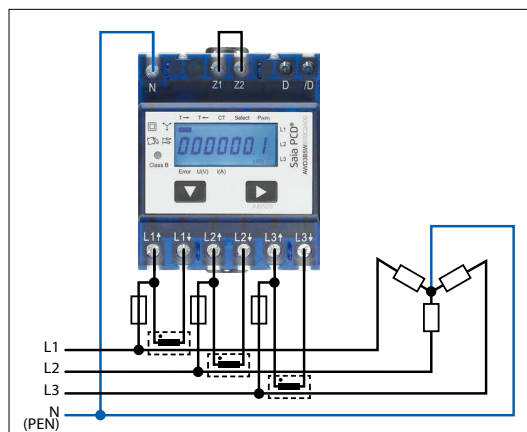

▲ Connected converters

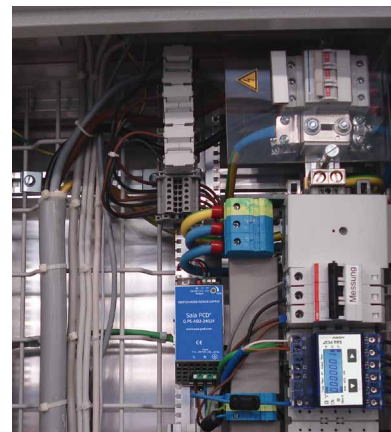

▲ Built-in current converter directly in the cable duct

MTBF values for Saia PCD® energy meters

The quality, robustness and reliability of the energy meters is also shown by the MTBF values, which have been calculated in accordance with the Siemens standard SN 29500.

MTBF values at 25 °C

Energy meters without communication interface: 410 years

Energy meters with communication interface: 200 years

Measuring energy in both directions

With the bidirectional energy meters, energy can be measured in both directions of flow. The energy counters work in a balancing out fashion (mode 2), which means that they form the sum of all measured phase outputs analogue to the old Ferraris meters with a rotating disc.

The main area of use of bidirectional meters is wherever both energy flow directions occur (energy consumption and feed), such as in photovoltaic systems. FBoxes are installed for connection to the PCD world to capture the measured values.

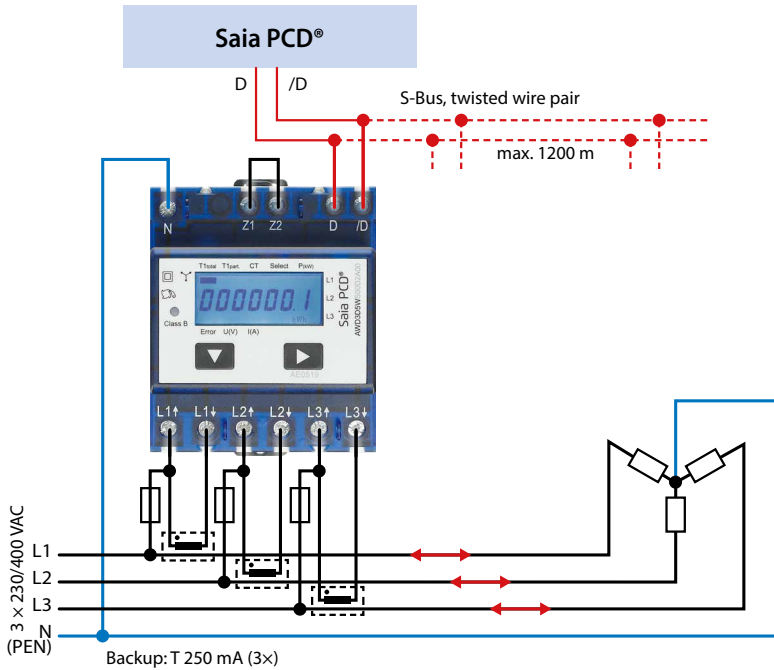

▲ Energy measurement of both current directions with one Saia PCD for further processing of the measured values

ePLAN[®] electric P8

EPLAN macros are available for project planning and engineering

ePLAN[®] data portal

The eplan[®] electric P8 macros are available on the support page. The macros and article data are also provided on the eplan[®] data portal.

Integrating the energy meter as a component in an existing, external system

The M-Bus energy meters can be integrated into any M-Bus system and can be read out with any M-Bus Master. This enables use in existing systems with an existing M-Bus infrastructure or even in new projects with various other M-Bus components. The energy meters with integrated serial Modbus RTU interface enable fast and secure communication with superordinate systems. The market offers many components for data transfer, backup and visualization of the measured data. Simple integration via various transmission channels is possible owing to the wide variety. With Modbus, existing equipment can be used without making costly new acquisitions.

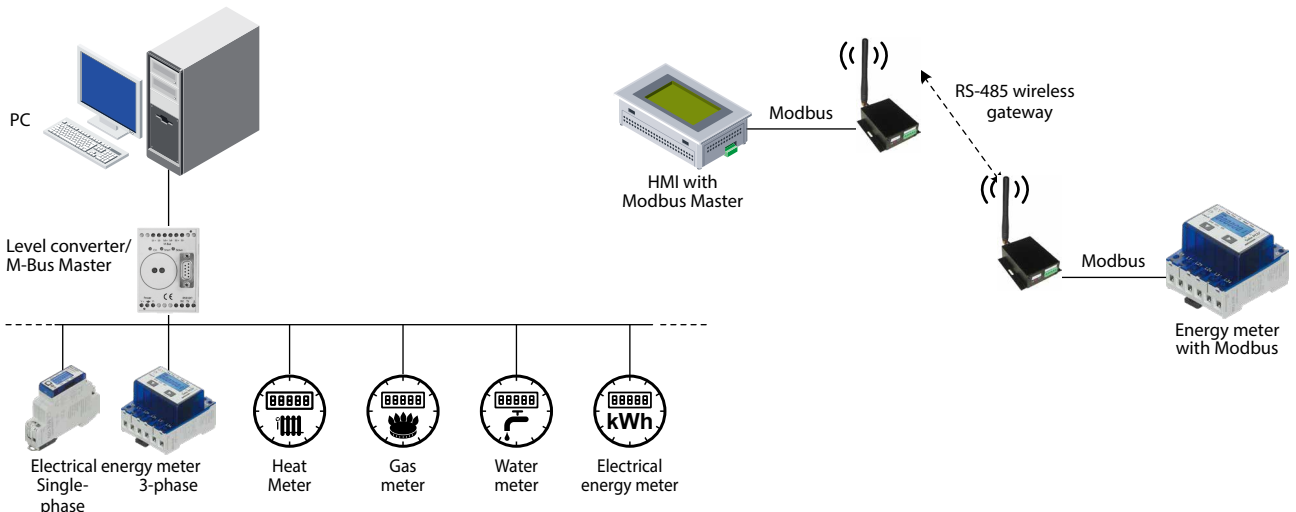

4.2.2 Energy meters with SBC S-Bus interface

The energy meters with integrated S-Bus interface offer all relevant data such as energy, current, voltage, output (active and reactive) and $\cos\phi$, which can be read out through the bus connection. The serial S-Bus interface (based on RS-485) can be connected directly to the Saia PCD range of devices. There are ready-made FBoxes for every meter type for this connection, which are available free of charge. The S-Bus energy meters are also available in a 2-way design (bidirectional). The bus address can be set on the display and the energy, current, voltage and active output can be read directly.

Connection diagram for M-Bus energy meters

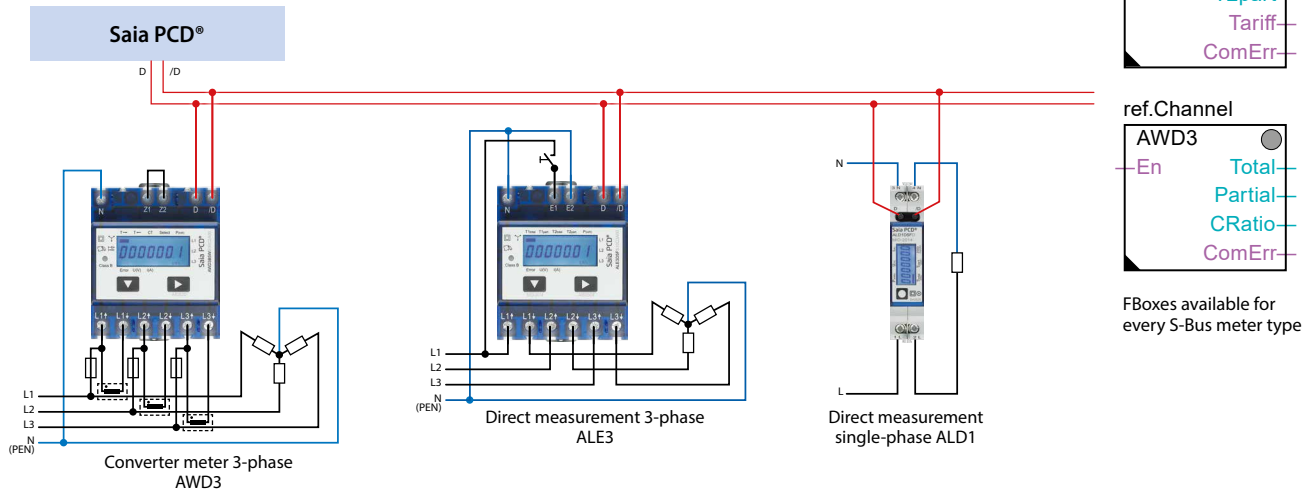

Technical Data

SBC S-Bus

Bus system	Serial RS-485 interface
Log	S-Bus data mode
Transmission rate	4,800, 9,600, 19,200, 38,400, 57,600, 115,200 baud. The transmission rate is detected automatically.
Bus cable	Twisted, shielded, 2 × 0.5 mm ² , max. 1200 m
Response time	Write: up to 60 ms Read: up to 60 ms



		ALD1		ALE3		AWD3	
		ALD1D5FS00A3A00	ALD1B5FS00A3A00	ALE3D5FS10C3A00	ALE3B5FS00C3A00	AWD3D5WS00C3A00	AWD3B5WS00C3A00
Tariff	1 tariff	•	•	-	•	•	•
	2 tariffs	-	-	•	-	-	-
Meter type	Unidirectional design	•	-	•	-	•	-
	Bidirectional design	-	•	-	•	-	•
Approvals	With MID	•	•	•	•	•	•
Rated/max. current Current	$I_{\min} = 0.05 \text{ A}, I_N = 5 \text{ A}, I_{\max} = 6 \text{ A}$	-	-	-	-	•	•
	$I_{\min} = 0.25 \text{ A}, I_N = 5 \text{ A}, I_{\max} = 32 \text{ A}$	•	•	-	-	-	-
	$I_{\min} = 0.5 \text{ A}, I_N = 10 \text{ A}, I_{\max} = 65 \text{ A}$	-	-	•	•	-	-
Measurement type	Direct measurement	•	•	•	•	-	-
	Conversion up to 1500 A	-	-	-	-	•	•
Operating voltage	230 VAC, 50 Hz	•	•	-	-	-	-
	3 × 230/400 VAC, 50 Hz	-	-	-	-	•	•
Partial meter	Resettable	•	-	•	•	•	-

4.2.3 Energy meter with M-Bus interface

The M-Bus interface enables the connection and reading of measured data through any Saia PCD or any M-Bus Master. The meters correspond to M-Bus standard EN 13757. For connection to Saia PCD systems, prefabricated FBoxes are available free of charge for Saia PCD energy meters. The relevant measurement data, such as energy, current, voltage and output (active and reactive) can be read out via the M-Bus interface. On the display, the bus primary address can be set and the energy, current, voltage and active output can be read directly.

Connection diagram for M-Bus energy meters

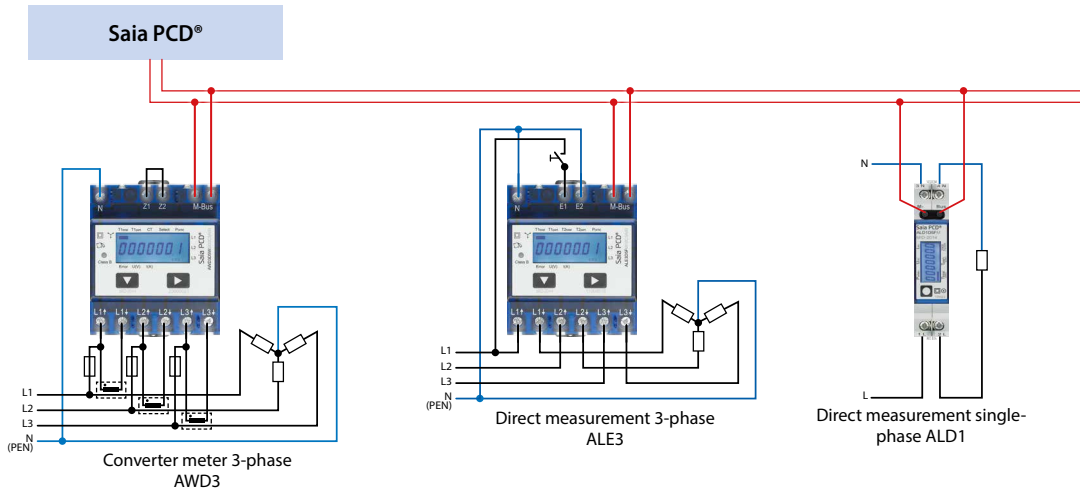

ref.Channel	ALD	Ttot
-En	Tpart	Pa
-Res	Pr	U
	I	ComErr
ref.Channel	ALE	T1tot
-En	T1part	T2tot
-Res 1	T2part	Tariff
-Res 2	ComErr	
ref.Channel	AWD	T1tot
-En	T1part	ComErr
-Res		
ref.Channel	AWD/ALE	U_L1
-En	U_L2	U_L3
	I_L1	I_L2
	I_L3	Pa_L1
	Pa_L2	Pa_L3
	Pr_L1	Pr_L2
	Pr_L3	CRatio
	ComErr	

FBoxes available for every M-Bus meter type

Technical Data

M-Bus

Bus system	M-Bus
Transmission rates	300, 2,400, 9,600 Baud. The transmission rate is detected automatically
Addressing	Primary and secondary
Bus length (max.)	In accordance with M-Bus specifications
Response time	Write: up to 60 ms Read: up to 60 ms



		ALD1	ALE3	AWD3
		ALD1D5FM00A3A00	ALE3D5FM10C3A00	AWD3D5WM00C3A00
Tariff	1 tariff	•	-	•
	2 tariffs	-	•	-
Meter type	Unidirectional design	•	•	•
	Bidirectional design	-	-	-
Approvals	With MID	•	•	•
Rated/max. current Current	$I_{min} = 0.05 A, I_N = 5 A, I_{max} = 6 A$	-	-	•
	$I_{min} = 0.25 A, I_N = 5 A, I_{max} = 32 A$	•	-	-
	$I_{min} = 0.5 A, I_N = 10 A, I_{max} = 65 A$	-	•	•
Measurement type	Direct measurement	•	•	-
	Conversion up to 1500 A	-	-	•
Operating voltage	230 VAC, 50 Hz	•	-	-
	3 × 230/400 VAC, 50 Hz	-	•	•
Partial meter	Resettable	•	•	•

4.2.4 Energy meter with Modbus interface

The integrated Modbus RTU interface complies with the IDA specification and is based on an RS-485 interface. The measurement data from the energy meter can be connected to any Modbus Master to read out the measured values. The relevant measurement data, such as energy, current, voltage, output (active and reactive) and $\cos\phi$ can be read out via the interface. The bus address can be set and the energy, current, voltage and active output can be read direct on the display. Prefabricated FBoxes are available to connect the energy meters to Saia PCD systems, which are supplied free of charge.

Connection diagram for Modbus energy meters

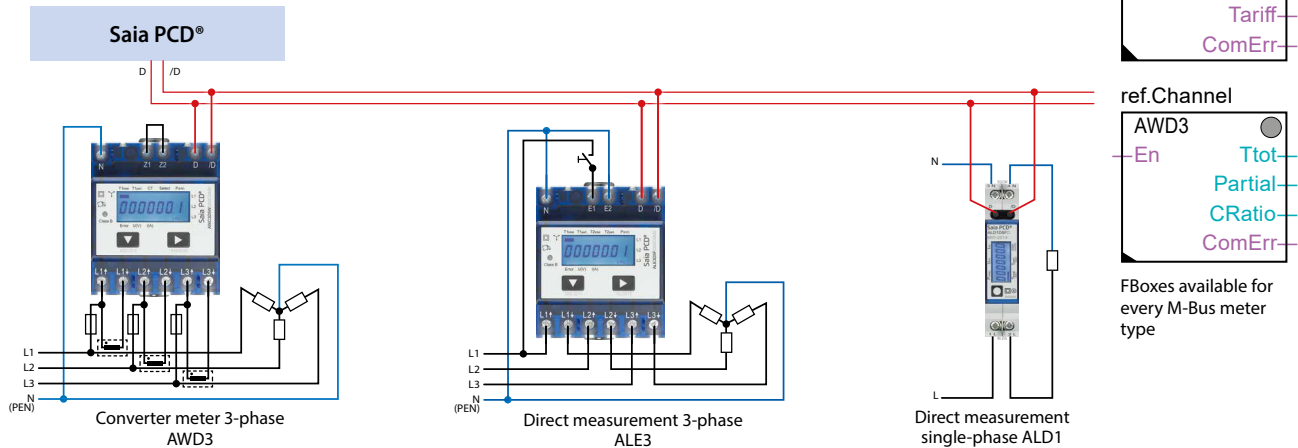

Technical Data

Modbus

Bus system	Serial RS-485 interface
Log	Modbus RTU as per IDA specification
Transmission rates	4,800, 9,600, 19,200, 38,400, 57,600, 115,200 baud. The transmission rate is detected automatically
Bit settings	<ul style="list-style-type: none"> ▶ 8 databit, even parity, 1 stop bit ▶ 8 databit, odd parity, 1 stop bit ▶ 8 databit, no parity, 2 stop bit The parity is automatically detected
Bus cable	Twisted, shielded, $2 \times 0.5 \text{ mm}^2$, max. 1200 m
Response time	Write: up to 60 ms Read: up to 60 ms



The following devices are available for Modbus parity 8N1:

ALD1D5FD00A3A00
ALE3D5FD10C3A00
AWD3D5WD00C3A00



		ALD1	ALE3	AWD3
		ALD1D5FD00A3A00	ALE3D5FD10C3A00	AWD3D5WD00C3A00
Tariff	1 tariff	•	•	•
	2 tariffs	-	•	-
Meter type	Unidirectional design	•	•	•
	Bidirectional design	-	-	-
Approvals	With MID	•	•	•
Rated/max. current Current	$I_{\min} = 0.05 \text{ A}, I_N = 5 \text{ A}, I_{\max} = 6 \text{ A}$	-	-	•
	$I_{\min} = 0.25 \text{ A}, I_N = 5 \text{ A}, I_{\max} = 32 \text{ A}$	•	-	-
	$I_{\min} = 0.5 \text{ A}, I_N = 10 \text{ A}, I_{\max} = 65 \text{ A}$	-	•	-
Measurement type	Direct measurement	•	•	-
	Conversion up to 1500 A	-	-	•
Operating voltage	230 VAC, 50 Hz	•	-	-
	$3 \times 230/400 \text{ VAC}, 50 \text{ Hz}$	-	•	•
Partial meter	Resettable	•	•	•

4.2.5 Energy meter with S0 pulse output

Energy meters with integrated S0 interface enable the transfer of measured energy to the devices of the Saia PCD family via pulses. With the S0 pulse counter PCD7.H104, the pulses can be requested via the RS-485 interface (S-Bus or Modbus).

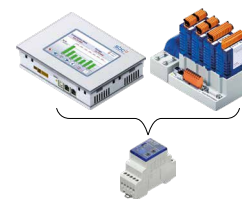

Connection diagram of S0 pulse energy meters, with S-Bus connection via PCD7.H104SE

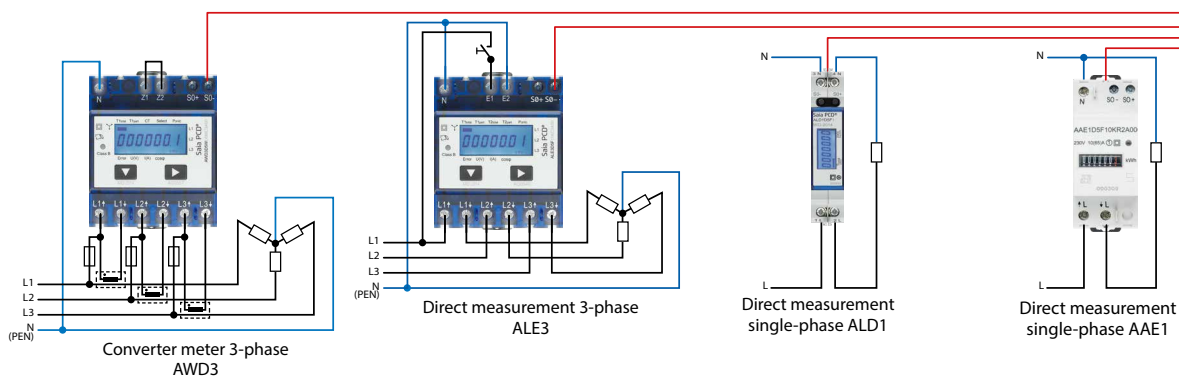

		ALD1	AAE1	ALE3	AWD3
		ALD1D5F10KA3A00	AAE1D5F10KR3A00	ALE3D5F11KC3A00 ALE3B5F10KC3A00	AWD3D5W10MC3A00 AWD3B5W10MC3A00
Tariff	1 tariff	•	•		•
	2 tariffs	-	-	•	-
Meter type	Unidirectional design	•	•	•	•
	Bidirectional design	-	-	-	•
Approvals	With MID	•	•	•	•
	Without MID	-	-	-	-
Rated/max. current	$I_{\min} = 0.05 \text{ A}, I_N = 5 \text{ A}, I_{\max} = 6 \text{ A}$	-	-	-	•
	$I_{\min} = 0.25 \text{ A}, I_N = 5 \text{ A}, I_{\max} = 32 \text{ A}$	•	-	-	-
	$I_{\min} = 0.5 \text{ A}, I_N = 10 \text{ A}, I_{\max} = 65 \text{ A}$	-	•	•	-
Measurement type	Direct measurement	•	•	•	-
	Conversion up to 1500 A	-	-	-	•
Operating voltage	230 VAC, 50 Hz	•	•	-	-
	$3 \times 230/400 \text{ VAC}, 50 \text{ Hz}$	-	-	•	•
S0 output	1000 Imp./kWh	•	•	•	-
	10 Imp./kWh	-	-	-	•
Partial meter	Resettable	•	-	•	-

4.2.6 Energy meter – sealing cover

Accessories

Order no.

Sealing cover for single-phase Saia PCD® energy meter EMD1 and ALD1

2 units are recommended for contact protection.

(Also for termination boxes PCD7.T161 and PCD7.T162, see Section 5.5)



4104 74200



ALD1 with assembled sealing cover

Sealing cover for – Single-phase Saia PCD® energy meter AAE1 – 3-phase Saia PCD® energy meter ALE3, and AWD3

2 units are recommended for contact protection on AAE1.

4 units are recommended for contact protection on ALE3 and AWD3.



4104 74850



ALE3 or AWD3 with sealing cover

Mounting frame for 3-ph energy meters of the families ALE3/AWD3

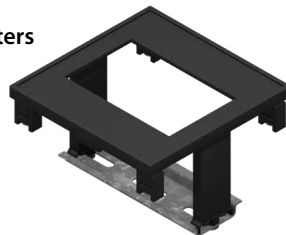

PMK-EEM400



ALE3 or AWD3 mounted in panel kit

4.2.7 Application notes

Application notes on the subject of "energy" can be found on the support page (www.sbc-support.com) under the section "energy meters".

Verschiedene Störungen

Impressionen und Effekte von gestörten Stromnetzen

Spannungsspitzen auf dem

Überlappung PLC Stand

Manuelle Überwälten

Störungen verfälschen das Messresultat!
Die angezeigten Signalwertungsgesamtheiten gehen von einem sinusförmigen Signal mit bestimmten Qualitätseigenschaften aus. Wenn diese Qualität nicht vorhanden ist werden die Messungen verfälscht.

Verbesserungsmaßnahmen:

- Installation und Verkabelung verbessern
- Lasten entlasten
- Netz entlasten

Beispiel eines Installationsproblems:
Nicht korrekter direkt neben Energiezähler

Wandler Technik / Wandler Typen

Stromwandler

Vorteile:

- Keine Isolierbox
- Hoher Preis
- Kleine Kompakte Bauform
- Bessere Genauigkeitsklassen (0,2S/0,5S)

Nachteile:

- Anbau/Austausch, da fix eingebaut

Kabelbau Stromwandler (Klappstromwandler)

Vorteile:

- Einfacher Ein- / Ausbau
- Einfach nachrüstbar

Nachteile:

- Hoher Preis
- Weniger Genauigkeitsklassen (0,5/1,0)

Beschriftung der Stromwandler Anschlussklemmen

Die Anschlüsse auf der primär Seite (Hauptstrom) sind IN, K, P1 / OUT, L, P2
Die sekundär Seite (Messstrom) hat die Bezeichnungen IN, K, S1 / OUT, L, S2

ACHTUNG: Wenn die Klammern S1/S2 vertauscht werden ist der gemessene Strom 180° verschoben!

4.3 Basic functions of the S-Monitoring application

Function for automatic capturing and saving of energy meter values – integrated into the operating system of the Saia PCD®

The S-Monitoring application works on all controllers ending in xx60 and on the pWeb Panels. The application consists of a COSinus function and an associated Web Editor project. This makes it possible to capture, save and visualise data without significant programming effort. With S-Bus meters, this works without any program in the controller.



S-Monitoring COSinus function

S-Monitoring is an integral part of the COSinus operating system and is integrated into all Saia PCD controllers ending with xx60 and having the pWeb Panel MB. It is activated in the PG5 Device Configurator and it scans connected meters automatically. The data is saved on the file system. In addition to connected S-Bus meters, any meter values available in the program can also be integrated.

The S-Monitoring function can read three different types of meters:

- ▶ Connected S-Bus energy meters and S0pulse counters (PCD7.H104SE)
- ▶ Other incremental meter values (M-Bus, Modbus, etc. are referred to as "custom meters" and captured via FBoxes in the Fupla program)
- ▶ Groups of meters

The S-Monitoring COSinus function comprises the following three parts:

1. Autoscan of S-Bus energy meters and pulse counters

If the S-Bus Autoscan is activated, meters connected to the RS-485 interface are automatically detected and read. By permanently requesting the meter data, remote diagnosis of the S-Bus meters and bus connection is possible.

Current S-Bus address 73	Found meters 5	State OK FW 1.3 HW 1.3 T1
------------------------------------	--------------------------	-------------------------------------

2. Provision of meter values via NT-EM tags (CGI interface)

All data and basic functions can be called up via CGI tags. These functions can therefore be accessed via the web interface or by other programs (e.g. Excel). The controller does not need a Fupla or IL program (see document 27-623).

NT-EM tag (CGI command) in the web browser:

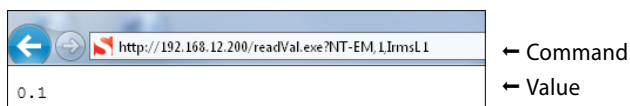

Excel Report Tool
When the COSinus function is activated, the data can simply be imported into Excel without programming.
Download: www.sbc-support.com

3. Saving the meter values in CSV files

The values of the energy meters connected are saved once a day at midnight in a CSV file on the internal file system of the PCD. The daily, weekly and monthly consumption can be calculated from this data. If an additional memory card is inserted, the values can be saved at 5-60 minute intervals. This makes it possible to visualise consumption over a day.

	A	B	C	D	E	F	G	H	I
1	Date	Energy1	Energy2	Tariff1	Tariff2	Energy3	Energy4	Tariff3	Tariff4
2	10.6.2013	206.10	0.00	0.1600	0.1300	160.00	13.23	0.1500	0.0800
3	11.6.2013	208.70	0.00	0.1600	0.1300	164.10	13.76	0.1500	0.0800
4	12.6.2013	214.43	0.00	0.1600	0.1300	168.13	14.82	0.1500	0.0800

S-Monitoring web project

SBC delivers a PG5 project, which also includes a web visualisation. The project is based on the COSinus functions and enables saved data to be visualised on the PC immediately. As only the S-Monitoring COSinus function is accessed in the web project, it does not need a PG5 program. It can therefore be easily integrated into existing projects. In addition, the most important websites are available as macros in Web Editor 8.

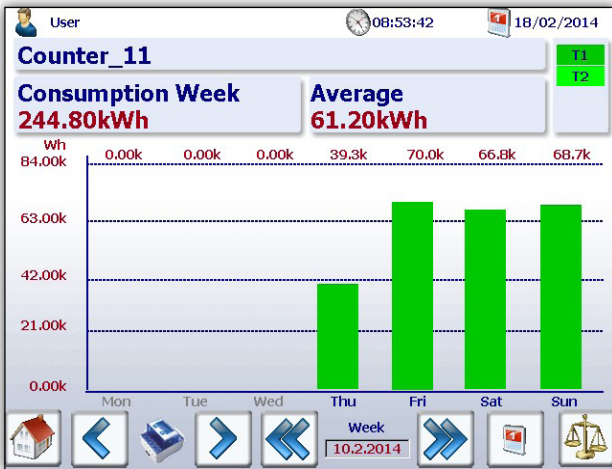

▲ Representation of historical energy consumption

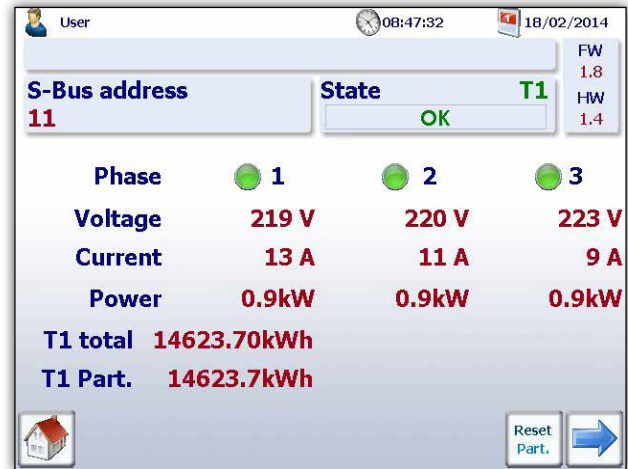

▲ Overview of the live values

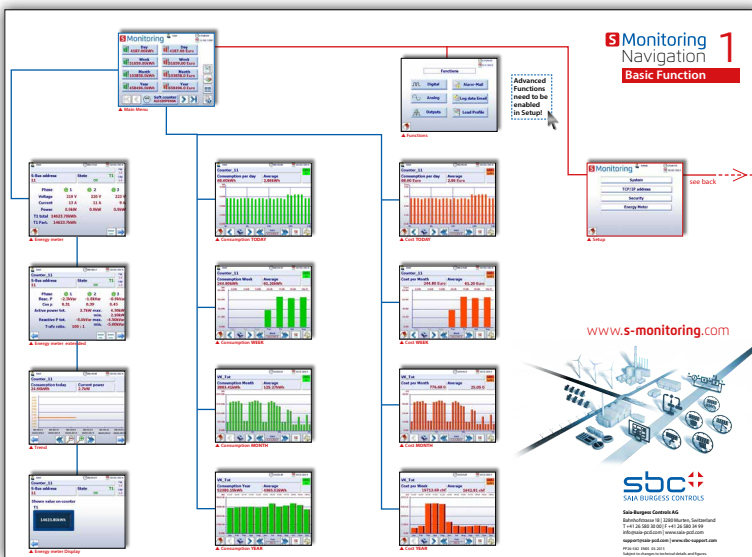

▲ Complete overview of the basic application

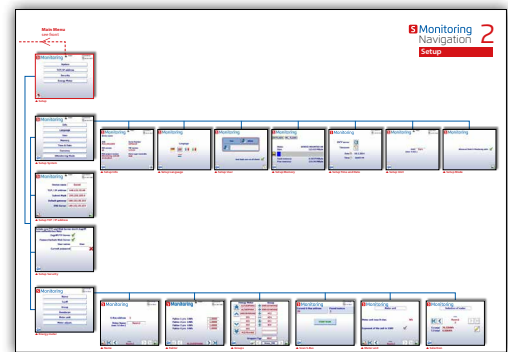

▲ Setup

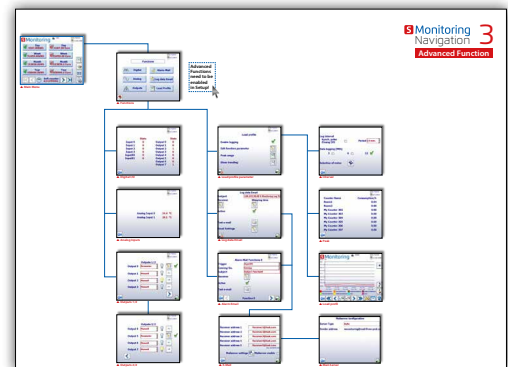













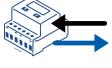



▲ Advanced

! S-Monitoring is also supported by pWeb Panel PCD7.DxxxxT5F, PCD1.M2160 and PCD3.Mxx60

😊 In the PG5 application for the E-Controller products supplied ready for use on delivery from the factory, additional "Advanced" functions are programmed in PG5. These cannot therefore be used without the program.

Basic functions of the S-Monitoring application

Recording of energy values	
 Automatic detection of connected energy meters	 Display of the energy meter status
 Grouping of energy meters	 Comparison between meter and periods
 Connection of bidirectional meters	 Connection PCD7.H104SE S0 impulse counter (for S0 meters)
Display and analysis of energy values	
 Current meter values such as consumption, voltage, current, active and reactive power and cosφ	 Evaluation and presentation of the costs
 Visualisation in bar charts and trend charts	 Consumption and costs presentation per day/week/month/year ¹⁾
 Data storage in Excel-readable CSV files	
Remote access via network and Internet	
 Operation at the PC with standard browser (IE, Chrome, Firefox)	 Operation via smartphone and tablet
 Access to log data and web project with FTP	 Integrated USB port for update and maintenance
User support	
 User administration	 Control interface in several languages

¹⁾ Daily view only available if memory extension is plugged in

Technical data for SBC S-Monitoring

SBC S-Monitoring COSinus function integrated in	PCD1.M0160E0 (E-Controller) PCD1.M2160	PCD3.Mxx60 PCD7.DxxxxT5F (pWeb Panel MB)
Supported meters	– Saia PCDS-Bus energy meters, PCD7.H104SE S0 pulse counters – Incremental meter values (M-Bus, Modbus, etc. are referred to as "custom meters" and captured via FBoxes in the Fupla program) – Meter groups	
Maximum number of meters	128 Saia PCD® S-Bus meters* / 256 custom meters* / 32 groups*	*in total max. 256
Data storage time	4 years maximum; a recording per day	
saved data	max. 4 meter values with 4 tariffs per meter are saved once a day (at midnight)	

4.3.1 S-Monitoring Web Editor 8 Templates

High initial costs for energy management are one of the largest barriers against investment, and the S-Monitoring application was developed as a door-opener to minimise these costs as far as possible. The basic functions of this S-Monitoring application were integrated in Web Editor 8. The programmer can therefore extend his project in accordance with individual requirements with energy monitoring functions. Improved and faster engineering enables added value that delivers a significant competitive advantage. For system integrators who want to visualise the energy consumption, the free S-Monitoring templates provide a saving of up to 2 weeks of engineering time.

Name of the library in Web Editor 8: S-Monitoring



▲ Monthly consumption

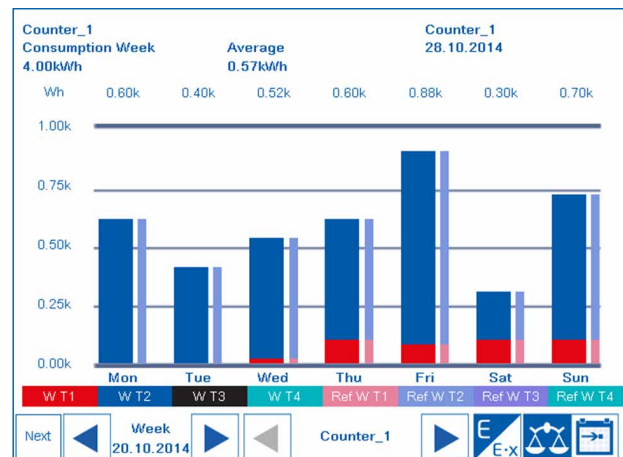

▲ Comparison of weekly consumption

Name	ALD1D5FS00A
State	Connected
Address	300
Counter Type	Soft Counter
User Type	ALD1D5FS00A
ASN	Not available
Serial number	Not available
Hardware version	Not available
Firmware version	Not available
Unit	Wh
Unit Exponent	0
Direction	UC
Raw counter value	2392.00
<div style="display: flex; gap: 5px;"> WT 1 WT 2 WT 3 WT 4 </div>	

▲ Counter information

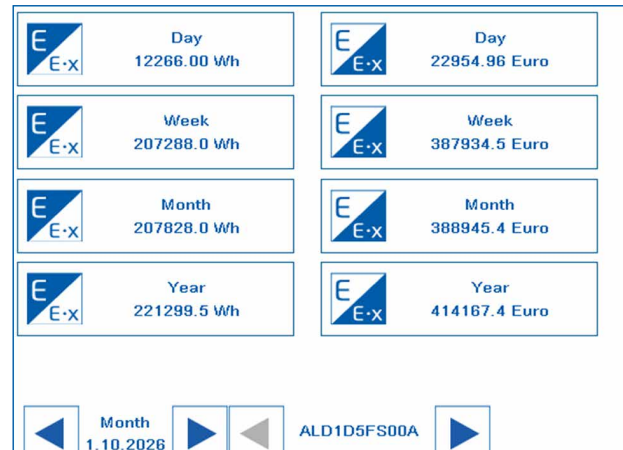

▲ Overview of energy consumption

Available templates

- ▶ Barograph day, week, month, year
- ▶ Navigation counter and period
- ▶ Live values of the energy counter
- ▶ Setup configuration

4.4 Saia PCD® E-Controller

Operational on delivery with local IOs

The E-Controller is an SBC functions PCD, which can be used immediately on delivery with no additional programming. It combines data capture, decentralised visualisation and logging in one compact device. Energy meters and pulse counters connected via the S-Bus interface are automatically detected and read. Historical data and the web visualisation can be accessed from anywhere via the integrated automation server using FTP and HTTP. This is also possible with mobile devices using SBC apps. In addition to the basic functions described in Section 4.6, simple control functions are already realised on the E-Controller. These include sending alarm emails and the parameterisation of outputs according to the meter values. The pre-installed S-Monitoring application can be adjusted, extended or replaced as required using PG5 and Web Editor. Additional protocols and data (e.g. from an M-Bus meter) can therefore be integrated using the optional communication interfaces. The design of the controller is suitable for installation in the distribution board next to the energy meters.



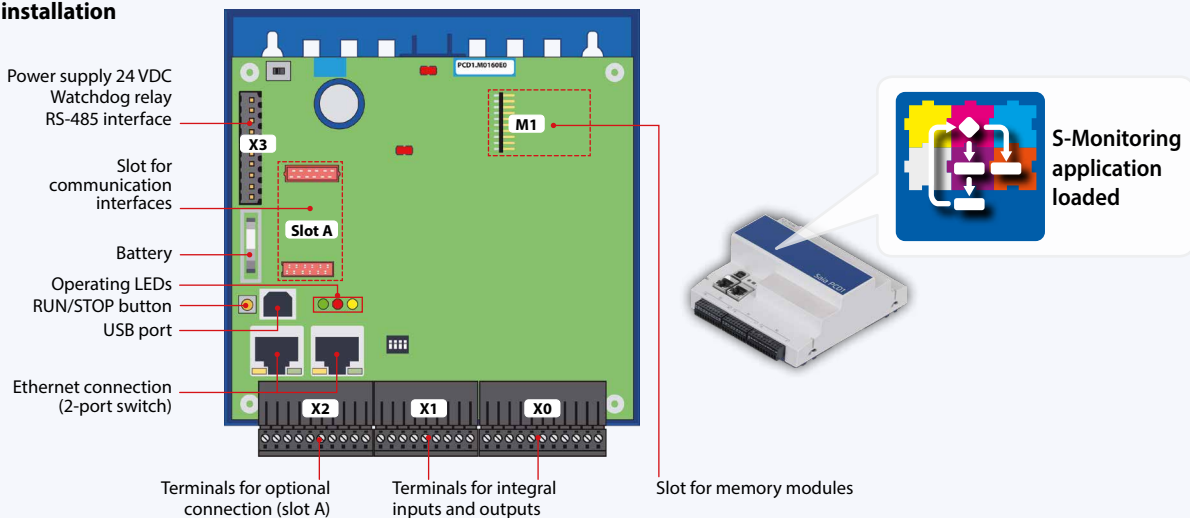

Device installation



Advanced functions

In addition to the basic functions of the web application (4.6), the E-Controller includes the following functions, which are programmed with Saia PG5®:

-  Load profile measurement of 8 consumption values
-  Sending of alarm and data emails to up to 5 email addresses
-  Parameterisation of outputs via min. and max. values

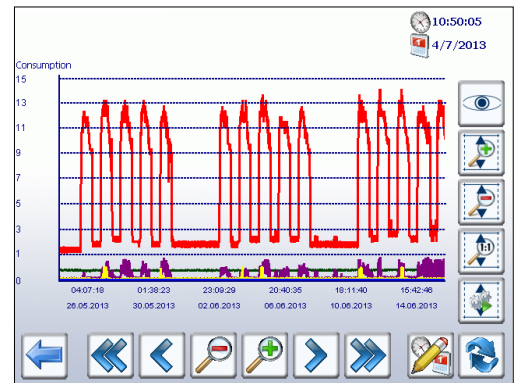

Load profile measurement

Mounting

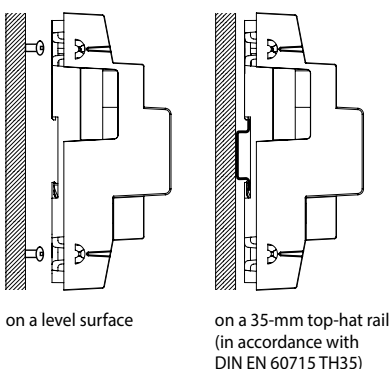

Dimensions

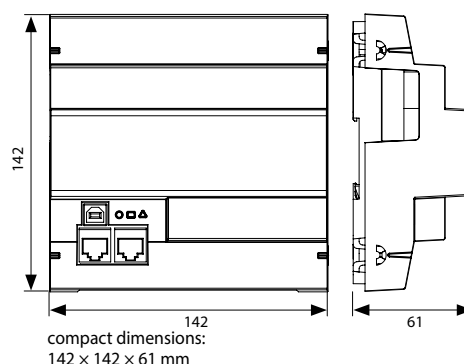

Power supply and connection plan

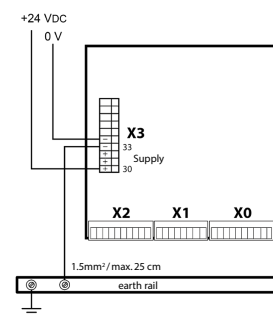

For more information, please see Chapter 1.2.1 Saia PCD3 power supply and connection plan, and in Manual 26-875.

Summary of E-Controller functions

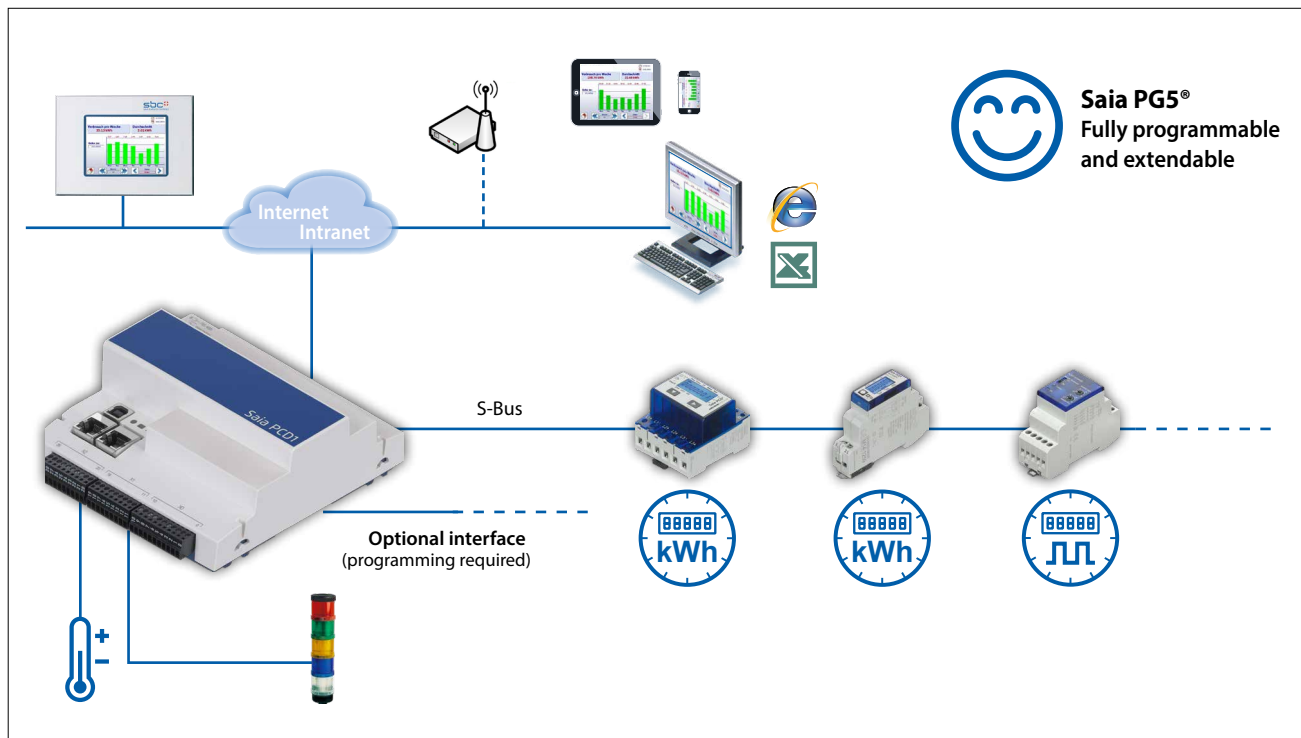

Automation stations

1

Operation and monitoring

2

Room controllers

3

Consumer data acquisition

4

Switch cabinet components

5

! Both the automatic detection of the meters and the E-Monitoring functionality can be switched off in the PG5 Device Configurator for unrestricted use of PCD1.M0160E0.

SBC MB App
Operation and monitoring on iPhone, iPad and Android

The image shows a hand interacting with a tablet displaying the SBC MB App interface. The screen shows various data points for energy consumption: 'Heute 0,07 kWh', 'Woche 0,20 kWh', 'Monat 0,29 kWh', 'Jahr 0,29 kWh', and 'Zähler Counter_00'. Below the tablet are the SBC MB logo and the Android and Apple logos.

Additional memory
Enables logs in 5–60 min. Interval and daily figures are illustrated for all meters in a bar chart.



PCD7.R610 Holder module for microSD card

PCD7-R-MSD1024 MicroSD memory card 1 GB, PCD formatted

Connection example of M-Bus with external interface¹⁾

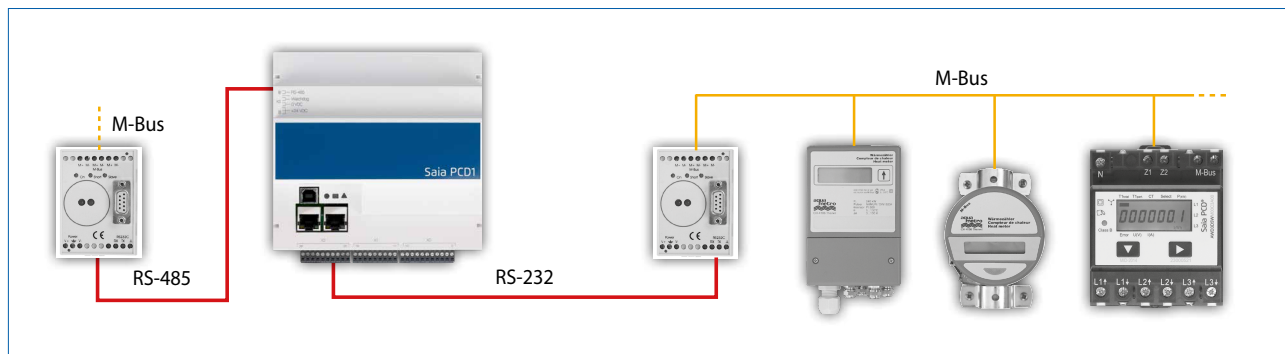

¹⁾ programming required

Overview of Saia PCD® E-Controller PCD1.M0160E0

Technical Data

Memory and file system	
Program memory, DB/text (Flash)	1 Mbyte
User memory, DB/text (RAM)	1 Mbyte
User flash file system onboard	128 Mbyte
Integrated communication	
Ethernet connection (2-port switch) 10/100 Mbit/s, full-duplex, auto-sensing, auto-crossing	Yes
USB connection USB 1.1 device, 12 Mbit/s	Yes
RS-485 (terminal X3), up to 115 kbit/s	Yes

General specifications

Operating voltage	24 VDC, -20/+25% max. incl. 5% ripple (as defined by EN/IEC 61131-2)
Battery for data backup (replaceable)	Lithium battery with a service life of 1 to 3 years
Operating temperature	0...55 °C
Dimensions (W x H x D)	142 x 142 x 60 mm
Mounting type	Top-hat rail in accordance with DIN EN 60715 TH35 (1 x 35 mm) or on a level surface
Protection type	IP 20
Capacity 5 V/+V (24 V) internal	max. 500 mA/200 mA
Power consumption	typically 12 W
Automation server	Flash memory, file system, FTP and web server, email, SNMP



Onboard inputs/outputs

Inputs:			
6	Digital inputs (4 + 2 interrupts)	15...30 VDC, 8 ms / 0.2 ms input filter	Terminal X1
2	Analogue inputs, selectable via DIP switch, preconfigured for Ni1000 in the default setup	-10...+10 VDC, 0...±20 mA, Pt1000, Ni1000, Ni1000 L&S, 0...2.5 kΩ, 12 bit resolution	Terminal X1
Outputs:			
4	digital outputs	24 VDC / 0.5 A	Terminal X0
1	PWM output	24 VDC / 0.2 A	Terminal X0
selectable/configurable via PG5			
4	Digital inputs or outputs, preconfigured for digital inputs in the default setup	24 VDC/data such as digital inputs or digital outputs	Terminal X0
1	Watchdog relay or as a make contact	48 VAC or VDC, 1 A mount a freewheeling diode over the load when switching DC tension	Terminal X3

Installation notes and recommendations

Assembly in the distribution board

The Saia PCD1.M0160E0 has the dimensions 142 x 142 x 60 mm excluding terminals and connections. For easy assembly, a gap of 55 mm above the DIN rail and 75 mm below it is recommended.

Ethernet cable

For installation in the sub-distributor, an angled or flexible network cable (e.g. SlimWire PRO) is recommended. The installation of a conventional network cable cannot guarantee the assembly of the sub-distributor cover.

Interface options Saia PCD® E-Controller (PCD1.M0160E0)

In addition to the onboard interfaces, modular expansion of interface functions is possible using slot A. For this purpose, the Saia PCD1.M0160E0 supports numerous protocols. A detailed list of all protocols is contained in Chapter B2 "Communication & Interaction".

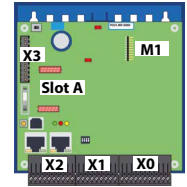

Communication		Current consumption at 5V bus	Current consumption at +V bus (24 V)	
PCD7.F110S	RS-422 avec RTS/CTS ou RS-485 ¹⁾	40 mA	---	Slot A
PCD7.F121S	RS-232 with RTC/CTS, DTR/DSR, DCD, suitable for modem, EIB or , DALI connection	15 mA	---	Slot A
PCD7.F150S	RS-485 ¹⁾	130 mA	---	Slot A
PCD7.F180S	Belimo MP-Bus, for connecting up to 8 drives on one line	15 mA	15 mA	Slot A

¹⁾ with line termination resistors that can be activated.



Analogue output module Saia PCD7.W600

This module has 4 analogue outputs 0 to +10 V with a 12-bit resolution and has been specifically developed to use with the new PCD1 CPUs (PCD1.M2xxx, PCD1.M0160E0, PCD1.M2110R1). It can be plugged into slot A of the PCD1 CPU like the PCD7.F1xxS communication module.



Memory modules

The onboard memory can be expanded with a PCD7.Rxxx module in slot M1. The E-Controller can also be expanded with BACnet®.

For more information on memory management and structure, see the Chapter Saia PCD System Description.

Memory expansion and communication

PCD7.R562	Flash memory module for BACnet® firmware with 128 MB file system	M1
PCD7.R610	Basic module for Micro SD flash card	M1
PCD7.R-MSD1024	Micro SD flash card 1024 MB, PCD formatted	PCD7.R610



PCD7.R562



PCD7.R610



For the parallel operation of S-Monitoring and BACnet®, please note the instructions on the support site (www.sbc-support.com).

Accessories and consumables

EPLAN macros

EPLAN macros are available for project planning and engineering



The EPLAN® electric P8 macros are available on the support site.

The macros and article data are also provided on the EPLAN® data portal.



Battery for data backup

Type	Description
450748170	Lithium battery for PCD processor unit (RENATA button battery type CR 2032)



Plug-in screw terminal block

440550890	Plug-in screw terminal block, 11-pin, labelling 0...10	Terminal X0
440550870	Plug-in screw terminal block, 9-pin, labelling 11...19	Terminal X1
440550880	Plug-in screw terminal block, 10-pin, labelling 20...29	Terminal X2
440549190	Plug-in screw terminal block, 10-pin, labelling 30...39	Terminal X3



4.5 S0 impulse counter PCD7.H104

S0 Collect, convert and transmit pulses

If already installed meters, which are not bus-capable, are to be integrated into an automation system, the Saia PCD7.H104 S0 pulse counter is the easiest way. This is the case for refurbishments, for example, if the existing meter infrastructure has to be made bus-capable and there is no question of buying new meters. With this S0 pulse counter, meters (electricity, water, heat, etc.) with an S0 pulse output from any manufacturer can be connected directly using a serial RS-485 S-Bus or Modbus connection to the Saia PCD or any controller. This enables efficient transfer, evaluation and forwarding of energy data without additional complicated coupler modules. For connection to Saia PCD systems, there are ready-made FBoxes. Via the interfaces, the number or valence of pulses can be transmitted.

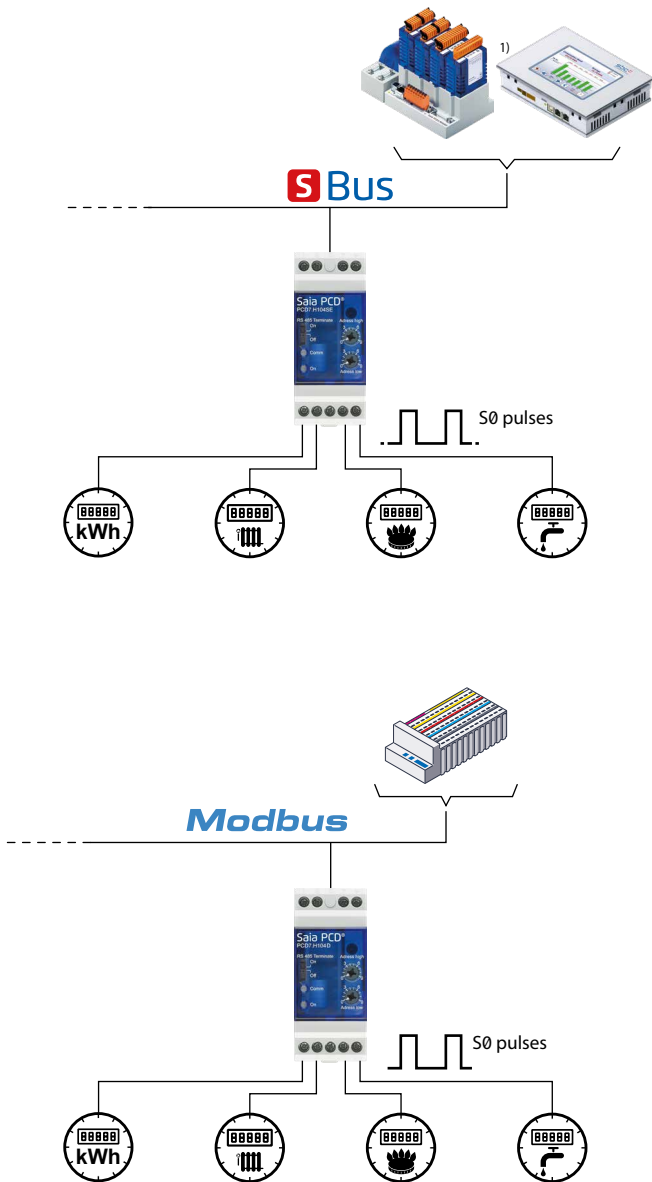

General technical data

Operating voltage	230 VAC (-20/+15 %)
Current draw	< 12 mA
Power consumption	< 3 W
Number of S0 inputs	4, in accordance with S0 IEC 62053-31
Frequency	max. 17 Hz
Pulse low/high	Min. 30 ms

S-Bus version

Order number	PCD7.H104SE
Log	S-Bus data mode
Bus system	Serial RS-485 interface
Transmission rate	2,400, 4,800, 9,600, 19,200, 38,400, 57,600, 115,200 The transmission rate is detected automatically
Bus length (max.)	1,200 m (without amplifier)
Response time	Write: 30 ms
System response time	Read: 20 ms

Modbus version

Order number	PCD7.H104D
Log	Modbus RTU as per IDA specification
Bus system	Serial RS-485 interface
Transmission rate (bit/s)	2,400, 4,800, 9,600, 19,200, 38,400, 57,600, 115,200 The transmission rate is detected automatically
Bit settings	8 databit, even parity, 1 stop bit 8 databit, odd parity, 1 stop bit 8 databit, no parity, 2 stop bit
Maximum bus length	1,200 m (without amplifier)
Response time	Type 5 characters
System response time	max. 60 ms

! Device PCD7.H104DZ44 must be used for parity 8N1!

Size

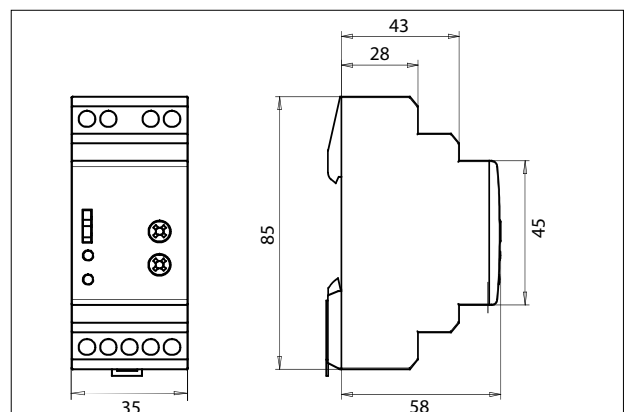

FBoxes for integration into FUPLA

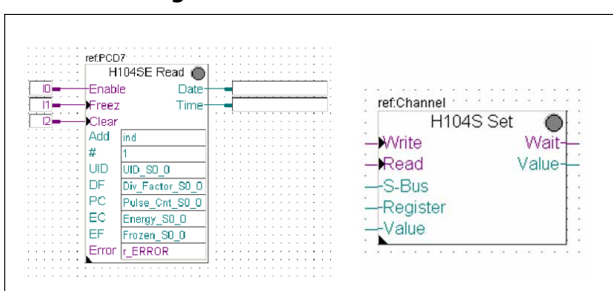

A5 Switch cabinet components

The comprehensive range of accessories for automation technology from Saia Burgess Controls (SBC) ensures a reliable operation of the systems. Modules such as S-Bus RIO modules, isolating amplifiers, coupler modules and relays are available in addition to power supplies and Ethernet switches.



5.1 Power units for installation in control cabinets

Page 139

Different types of 24 VDC power supplies with diverse output power

5.2 Power supplies for installation in electric distributor boxes

142

24 VDC power supplies for installation in electrical sub-distribution

5.3 Industrial VPN Routers

144

LAN and 3G/HSPA industrial router for DIN rail mounting

5.4 Industrial Ethernet switches

146

Industry-quality compact switches for DIN rail mounting with 5 or 8 ports

5.5 RS-485 bus termination box PCD7.T16x

147

Termination box for the termination of RS-485 networks for DIN rail mounting with a 24 V or 230 V power supply

5.7 Interface modules with local override

149

Coupler modules to control drives, valves or flap systems

5.8 I/O module integration into the switch cabinet

150

Pre-assembled system cables and terminal adapter modules support the fast integration of the Saia PCD I/O modules into the switch cabinet.

5.1 Power units for installation in control cabinets

SBC power units with 24 VDC output provide an ideal power supply for automation solutions owing to their high level of resistance to interference. They can also be used to operate high-output loads, as they can be heavily overloaded for short periods. The full extent of their flexibility is demonstrated by the option to connect multiple devices in parallel to increase the maximum output current or to connect them in series to achieve different voltage levels.

Power unit overview

SBC Power Flex single-phase 110/230 VAC

- ▶ Q.PS-AD2-2402F (up to 3 A)
- ▶ Q.PS-AD2-2405F (up to 7.5 A)
- ▶ Q.PS-AD2-2410F (up to 14 A)

Uninterruptible power unit single-phase 110/230 VAC with intelligent battery charger

- ▶ Q.PS-ADB-2405-1 (5 A)

SBC single-phase 24 VAC/40 VDC

- ▶ Q.PS-AD1-2403 (3 A)



From left to right: Q.PS-ADB, Q.PS-AD2, Q.PS-AD1

System properties in general

- ▶ Short-circuit protection
- ▶ Overload protection
- ▶ IP 20 housing for mounting on DIN rail

Properties of Flex types 24xxF

- ▶ Power boost: +40% additional output current up to 60 °C for at least 3 minutes
- ▶ With AD2-2405F and 2410F, a range of short-circuit modes available
- ▶ "Power good" relay for status display
- ▶ With 2410F, simple parallel connection (via jumper) to increase max. output current
- ▶ Output voltage up to 150 VDC possible in serial mode
- ▶ Extremely compact

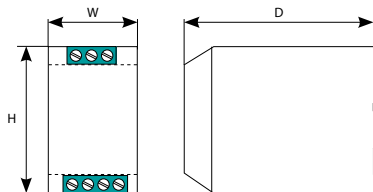

Dimensions	Q.PS-AD2-2402F	Q.PS-AD2-2405F	Q.PS-AD2-2410F	Q.PS-ADB-2405-1	Q.PS-AD1-2403
Width (W)	50 mm	55 mm	72 mm	65 mm	50 mm
Height (H)	120 mm	110 mm	115 mm	115 mm	95 mm
Depth (D)	50 mm	105 mm	135 mm	135 mm	61 mm
Weight	0.3 kg	0.6 kg	0.6 kg	0.6 kg	0.2 kg

Properties of the uninterruptible power unit

- ▶ 3-stage automatic charging curve to compensate the self-discharge of the battery
- ▶ Automatic real-time diagnostics of the battery status and test function for the battery service life
- ▶ Any battery fault can be easily identified via blinking codes of the diagnostics LED
- ▶ Option of status and battery fault reporting in the control system via 2 potential-free contacts
- ▶ Adjustable charging current 1...5 A

Standards and certifications

- ▶ In accordance with
 - CE
 - cULus Listed 508 Industrial Control Equipment

Electrical safety:

For the assembly devices in accordance with IEC/EN 60950 (VDE 0805) and EN 50178 (VDE0160). The unit must be installed in accordance with IEC/EN 60950.

EMC Generic

Immunity in accordance with EN 61000-6-2
Noise emission in accordance with EN 61000-6-4

Technical Data

Input data	Q.PS-AD2-2402F	Q.PS-AD2-2405F	Q.PS-AD2-2410F
Input voltage	115...230 VAC		
Permitted voltage range:	90...264 VAC	90...135 / 180...264 VAC	
Inrush current (at V_n and I_n)	$\leq 7 \text{ A} \leq 5 \text{ ms}$	$\leq 11 \text{ A} \leq 5 \text{ ms}$	$\leq 16 \text{ A} \leq 5 \text{ ms}$
Frequency range	47...63 Hz ($\pm 6\%$)		
Input current (for operating voltage 110 / 230 VAC)	1.0 / 0.7 A	2.8 / 1.0 A	3.3 / 2.2 A
Internal input fuse	4 A		6.3 A
External preliminary fuse recommended	Fast-acting 6 A	Fast-acting 10 A	Fast-acting 14 A

Output data	Q.PS-AD2-2402F	Q.PS-AD2-2405F	Q.PS-AD2-2410F
Output voltage (V_n) / nominal current (I_n)	24 VDC $\pm 3\%$ / 2.5 A	24 VDC $\pm 3\%$ / 5 A	24 VDC $\pm 3\%$ / 10 A
Adjustment range (V_{adj})	22...27 VDC		
Switch-on delay	2 s (max.)	1 s (max.)	
Startup with capacitive load	$\leq 50,000 \mu\text{F}$		
Continuous running at $\leq 40^\circ\text{C}$	3 A (230 VAC)/2 A (115 VAC)	7.5 A	14 A
Continuous running at $\leq 50^\circ\text{C}$	2.5 A (230 VAC)/1.5 A (115 VAC)	6.0 A	12 A
Continuous running at $\leq 60^\circ\text{C}$	---	5.0 A	10 A
Maximum continuous current	---	---	---
Reserve out current (within 3 minutes at $\leq 60^\circ\text{C}$)	3.5 A	7.5 A	14 A
Short-circuit current (I_{sc})	7 A	16 A	30 A
Residual ripple	$\leq 80 \text{ mVpp}$		
Efficiency (at 50% I_n)	$\geq 88\%$	$\geq 91\%$	
Short-circuit protection	Yes	Yes + 3 modes	
Overload protection	Yes		
Overvoltage output protection	Yes (max. 35 VDC)		
Parallel connection	Yes	Yes – simple	

Signal output (floating switch contacts)

Switching capacity	---	1 A / 30 VDC
Voltage drop > 10%	---	Yes

Climate data

Ambient temperature (operation)	$-25...+70^\circ\text{C}$ (load reduction > 50°C , 2.5%/°C)	$-25...+70^\circ\text{C}$ (load reduction > 60°C , 2.5%/°C)
Ambient temperature (storage)	$-40...+85^\circ\text{C}$	
Permissible humidity	95% at $+25^\circ\text{C}$; no moisture condensation permitted	

Overload protection

Mode

Jumper

Characteristics

Hiccup mode

Automatic restart
(default setting)
Attempts to switch
on the output volt-
age again every
2 seconds.

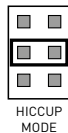

HICCUP
MODE

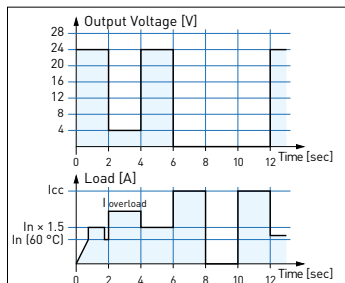

Manual reset mode

For a restart, it is nec-
essary to switch off
the input voltage for
approx. 1 minute.

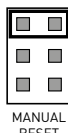

MANUAL
RESET

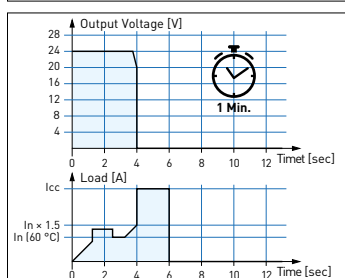

Mode

Jumper

Characteristics

Continuous out mode

The output current
remains at a high
value and the output
voltage is almost
0 volts.

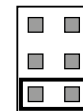

CONTINUOUS
OUT MODE

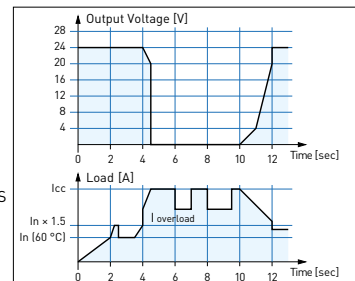

	Q.PS-AD1-2403		Q.PS-ADB-2405-1 Battery type
	24 VAC / 40 VDC		115...230 VAC
	24...32 VAC / 33...45 VDC		93...264 VAC
	---		≤ 14 A ≤ 5 ms
	47...63 Hz (±6%)		47...63 Hz (±6%)
	---		1.5 / 0.9 A
	---		4 A
	Fast-acting 10 A		Fast-acting 6 A
	24 VDC ± 2% / 3 A		24 VDC / 5 A
	---		---
	≤ 100 ms		2.5 s (max.)
	≤ 30,000 μF / 1.5 A		≤ 30,000 μF
	---		---
	3 A		---
	---		---
	1.05 × I _n ± 7%		1.1 × I _n ± 5%
	---		---
	---		---
	≤ 60 mVpp		≤ 60 mVpp
	≥ 91%		≥ 81%
	Yes		Yes
	Yes		Yes
	---		Yes
	---		---
	---		1 A / 30 VDC
	---		---
	-0...+50°C		-25...+70°C (load reduction >50°C, 2.5%/°C)
	-25...+85°C		-40...+85°C
95% at +25°C; no moisture condensation permitted			

Output characteristics

Output derating curve
Q.PS-AD2-2402F

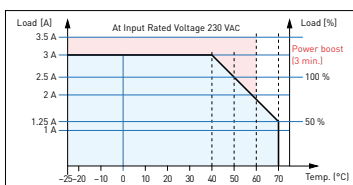

Output derating curve
Q.PS-ADB-2405-1

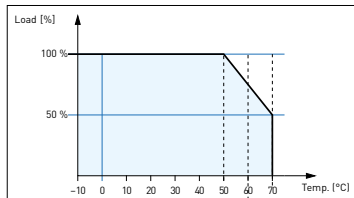

Output derating curve
Q.PS-AD2-2405F

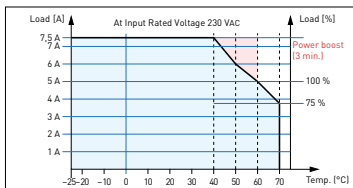

Output derating curve
Q.PS-AD2-2410F

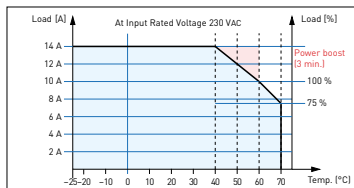

Battery output (battery type 3 ... 50 Ah)

Boost charge (25 °C) (at I _n)	28.8 VDC
Trickle charge (25 °C) (at I _n)	27.5 VDC
Output 2: Battery charging current max. I _{Batt}	5 A ± 5%
Setting range of charging current	20...100% of I _n
Recovery charge after deep discharge	Yes
Configuration jumper: Battery type	Yes
Reverse polarity protection	Yes
Monitoring of the sulfation of the battery cells	Yes
Detection of an element in short-circuit	Yes

Load output

Output voltage (at I _n)	22...28.8 VDC
Max. nominal current I _n = I _{load} + I _{batt} (120 W)	1.1 × 5 A ± 5%
Output 1: Load current (main) I _{load}	15 A max.
Output 1: Load current (backup) I _{load}	10 A max.

Signal output (floating switch contacts)

Switching capacity	1 A / 30 VDC
Main or backup power unit	Yes
Defective battery/low battery	Yes

5.2 Power units for installation in electrical distributor boxes

The compact Q.PS-PEL-240x power units with 24 VDC output voltage can be installed in a very restricted space and therefore the installation in cost-effective electrical distributor boxes in accordance with DIN 43880 is possible. They are therefore ideally suited for combining with the E-Line family. Modern push-in terminals enable efficient and fast wiring without the use of tools.

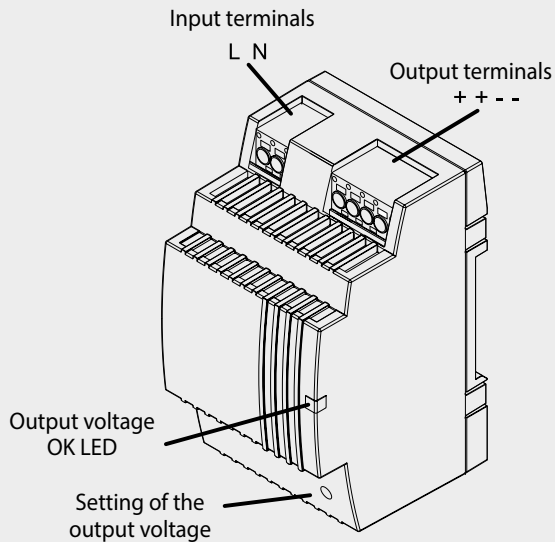

Power unit overview

Single phase 110/230 VAC

- ▶ Q.PS-PEL-2401: 24 VDC / up to 1.3 A
- ▶ Q.PS-PEL-2403: 24 VDC / up to 4.0 A

Standards and certifications

Compliant certifications

- ▶ CE
- ▶ DNV GL (shipping approval)
- ▶ UL (cURus, cULus)
- ▶ EAC

Electrical safety

- ▶ EN61558
- ▶ EN60950 (SELV)

EMC

- ▶ EN61204-3
- ▶ Immunity pursuant to EN61000-6-2 (for the industrial sector)
- ▶ Emitted interference in accordance with EN61000-6-4 (for the domestic sector)

Dimensions

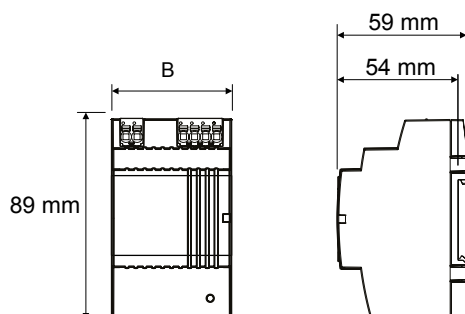

Model	Q.PS-PEL-2401	Q.PS-PEL-2403
Width (W)	54 mm	90 mm

System properties

- ▶ Short-circuit protection and constant overload limiter
- ▶ Protection class II (in closed switch cabinet) → dual isolation
- ▶ Power failure bypass up to 100 ms
- ▶ LED for output voltage OK display
- ▶ Stabilised and adjustable output voltage for the conductor resistance compensation
- ▶ Parallel operation possible to increase max. output current
- ▶ IP20 housing for mounting on DIN rail

Mounting in the sub-distributor

The design of the Q.PS-PEL2-40x power units complies with the required standard dimensions according to DIN 43880. The power units can therefore be easily integrated in electrical distribution boxes and are ideally suited to supply the components of the E-Line family with voltage



Terminal technology

Push-in terminals for efficient and fast wiring without tools for single wire conductors with a cross section of up to 2.5 mm² or fine wire ferrules up to 1.5 mm². However fine wire conductors up to 2.5 mm² can also be connected directly by simply applying pressure (screwdriver).

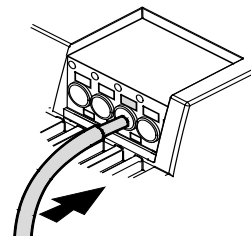

Installation information

Distance to adjacent parts:
 Right/left: no minimum distance required
 Top/bottom: min. 50 mm

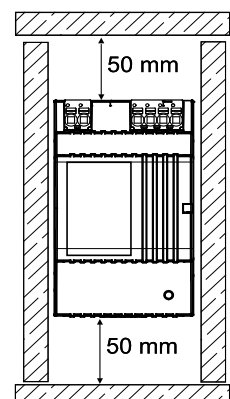

Technical data

Input data	Q.PS-PEL-2401	Q.PS-PEL-2403
Input voltage	100...240 VAC	
Permitted input voltage range	85...264 VAC	
Nominal frequency range	44...66 Hz	
Nominal input current for nominal load (110 / 230 VAC)	0.7 / 0.5 A	1.6 / 0.9 A
Internal input fuse	2 AT	4 AT
Recommended external pre-fuse	6 A, 10 A, 16 A, characteristics B, C	
Power failure bypass for nominal load (110 / 230 VAC)	10 / 80 ms	15 / 100 ms

Output data

Output voltage (V_N)	24 VDC \pm 2%	
Output voltage range (V_{ADJ})	22.8...26.4 VDC	
Output current (I_N) at $\leq 45^\circ\text{C}$	1.3 A	4 A
Output current (I_N) at $\leq 55^\circ\text{C}$	0.9 A	2.8 A
Current load rating for any installation system	max. 0.9 A	max. 2.4 A
Efficiency	typical 82%	typical 88%
Residual ripple (for nominal load)	≤ 100 mVpp	
Overload behaviour	Constant current (U/I characteristic curve)	
Short-circuit protection	Yes	
Overvoltage output protection	Yes (max. 30 VDC)	
Parallel connection	Yes	

Status

Operating indicator	LED green
---------------------	-----------

Environment

Ambient temperature (operation)	-25°C to $+55^\circ\text{C}$ (load reduction $>45^\circ\text{C}$, 3%/°C)
Storage temperature	-25°C to $+80^\circ\text{C}$
Permitted humidity	30–85% relative humidity, no condensation permitted
Areas of use	Use in areas with contamination level 2

Connection terminals

Connections	Push-in
Input/output terminals	Single wire and fine wire conductors up to max. 2.5 mm ² / conductors with wire ferrules up to max. 1.5 mm ²

Output characteristics

Voltage/current characteristic curve for short-circuit and overload protection

Output Characteristic (U/I Characteristic)

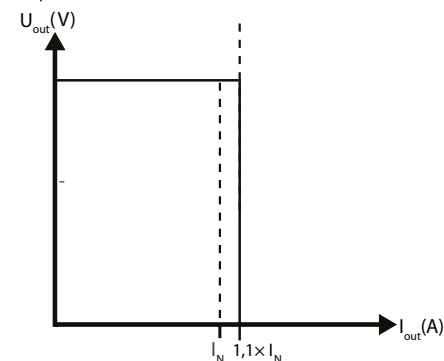

The current overload protection limits the current to a constant value of $1.1 \times$ nominal current

Output derating curve

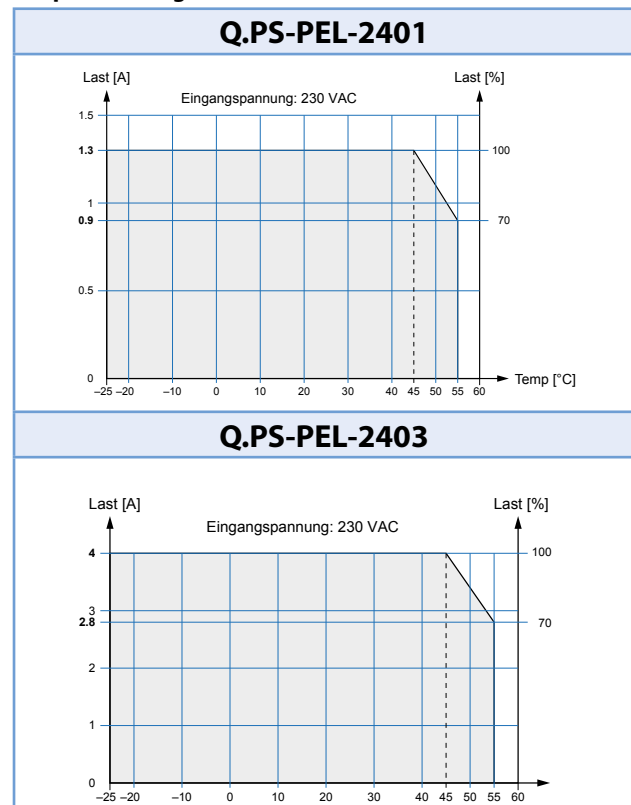

5.3 Industrial VPN Routers

The EBW industrial routers allows you an easy, reliable and secure connection of different applications located on different sites.

Using the quick start wizard, the EBW routers can be quickly and easily integrated in the "SBC Connectivity service" VPN network. These industrial routers enable professional IP routing and provide highest-possible IT security.

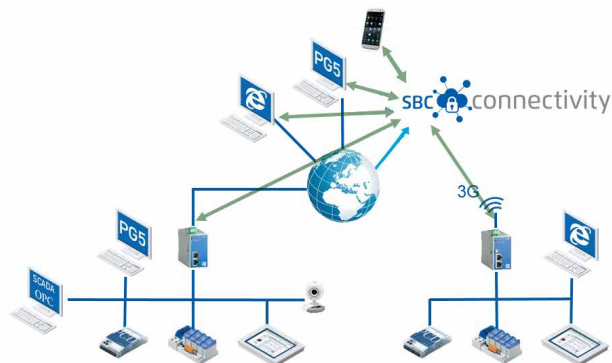

5.3.1 Industrial 3G/HSPA router for VPN connection

The industrial high speed router EBW-H100 combines a modem and a router in one device. It connects to the internet over mobile networks (3G/HSPA, GPRS/EDGE).

The dial-in and dial-out functionality enables remote maintenance and operation of devices in an Ethernet network. A firewall and integrated VPNs (openVPN, IPsec) care about data security.



Typical applications

- ▶ Access to control network with PLC, HMI, data logger
- ▶ Modem substitute for devices with Ethernet interface
- ▶ Remote desktop
- ▶ Video monitoring
- ▶ Displays

Features

- ▶ Broadband 3G/HSPA
- ▶ Dial-in and dial-out router
- ▶ VPN security
- ▶ Two local Ethernet ports
- ▶ Prepared for INSYS Connectivity Service

Technical data EBW-H100

Mobile Communication

Networks	2G: 900/1 800 MHz; CSD, GPRS/EDGE Class 12 3G: 850/800, 900, 1 900, 2 100 MHz; UMTS, HSDPA, HSUPA
Antenna	SMA connection
SIM	1 slot for Mini-SIM card

Router

Funktion	Dial-In, dial-out, callback, connection management, DHCP server and client, full NAT (port forwarding, netmapping), DNS relay, dynDNS support, SNMP, NTP client and server, buffered real-time clock
Security	OpenVPN (client and server), IPsec, PPTP, MAC firewall, 10 user for dial-in, authentication over PAP/CHAP/MS-CHAP/MS-CHAP 2, dial filter for dial-out, linkloss detection, failed login detection, GRE
Redundancy	2 dial-out targets, 2 OpenVPN server targets

LAN

Ports	2×RJ45
Operating mode	10 / 100 MBit/s for full and half duplex operation
Function	Automatic detection of patch cable / cross-over cable, Automatic speed adjustment; MDI/MDI-X

Messages

	Hardware watchdog, system messages via e-mail, SNMP traps, SNMP V1 /V2c/V3
--	--

Additional features

	Update of firmware and configuration (local and remote), daily auto update
--	--

Supply

Connections	10 ... 48 V DC (±20%)
Input/output terminals	Approx. 2 W (logged in), max. 5 W (during communication)

Physical features

Dimensions (L×W×H)	110×45×70 mm
Operating temperature	-30 ... +70 °C -30 ... +85 °C under limited conditions (refer to www.insys-icom.com/restricted)
Humidity	0 ... 95% (non-condensing)

5.3.2 Industrial LAN router for VPN connection

The industrial high-speed router EBW-E100 allows secure connections between local and remote networks.

EBW-E100 decouples manufacturing cells with remote access from the surrounding company IT for example. Also many subnetworks with identical local IP addresses can be distinguished and addressed targeted.

The firewall and VPN via OpenVPN and IPsec provide data security.



Typical applications

- ▶ Manufacturing cell decoupling
- ▶ Secure remote maintenance in customer network
- ▶ Access to a control network from PLC, HMI, data logger
- ▶ Remote desktop
- ▶ Video monitoring
- ▶ Displays

Features

- ▶ LAN-to-LAN industrial router (1× LAN int., 1× LAN ext.)
- ▶ Professional IP routing
- ▶ Comprehensive security: Firewall, VPN, SNMP
- ▶ Easy consistent concept of operation
- ▶ Quick start for SBC Connectivity Service (VPN service)

Technical data EBW-E100

Router

Function	Connection management, DHCP server and client, full NAT (port forwarding, netmapping), DNS relay, dynDNS support, PPPoE client for ADSL, SNMP, NTP client and server, buffered real-time clock
Security	OpenVPN (client and server), IPsec, PPTP, MAC firewall, linkloss detection, failed login detection, GRE
Redundancy	2 OpenVPN server targets

LAN

Ports	2× RJ45
Operating mode	10/ 100 MBit/s for full and half duplex operation
Function	Automatic detection of patch cable / cross-over cable, Automatic speed adjustment; MDI/MDI-X

Messages

	Hardware watchdog, system messages via e-mail, SNMP traps, SNMP V1 / V2c / V3
--	---

Additional features

	Update of firmware and configuration (local and remote), daily auto update
--	--

Supply

Connections	10 ... 48 V DC (± 20%)
Input/output terminals	Approx. 2 W

Physical features

Dimensions (L×W×H)	110×45×70 mm
Operating temperature	-30 ... +70 °C -30 ... +85 °C under limited conditions (refer to www.insys-icom.com/restricted)
Humidity	0 ... 95% (non-condensing)

Order details

Q.NET-EBW-E100	Industrial LAN router for VPN connection
Q.NET-EBW-H100	Industrial 3G/HSPA router for VPN connection
Q.NET-CON	Annual license for the "SBC Connectivity Service" portal
PCD7.K840	GSM/UMTS (700/800/850/900/1'700/1'800/1'900/2'100/2'600 MHz) antenna with magnetic foot, 3 m cable and SMA (m) connector

5.4 Industrial Ethernet switches

This compact, unmanaged switch operates based on the plug-and-work principle. The mounted switch is equal in height to Saia PCD3 systems, which saves space when it is snapped onto the DIN rail. The PCD controller is connected with the patch cable provided. With its robust construction, this switch is suitable for use in harsh industrial environments and in infrastructure automation.

System properties

- ▶ DIN rail mounting and 24 VDC supply for flawless operation in infrastructure automation and in harsh industrial environments
- ▶ Fast network diagnosis, due to integral LEDs at TCP ports
- ▶ Entry level industrial Ethernet rail switch, with store-and-forward switching mode
- ▶ Allows construction of Ethernet networks in accordance with IEEE 802.3 with copper technology
- ▶ The device has five or eight 10/100 Mbit/s twisted pair ports (RJ45 connections)
- ▶ Up to five or eight end devices or additional TCP segments can be connected to the TCP ports using twisted pair
- ▶ Extremely light, compact construction with IP 30 protection level
- ▶ Simple commissioning with 'plug-and-work' via auto-negotiation, auto-polarity and auto-crossing

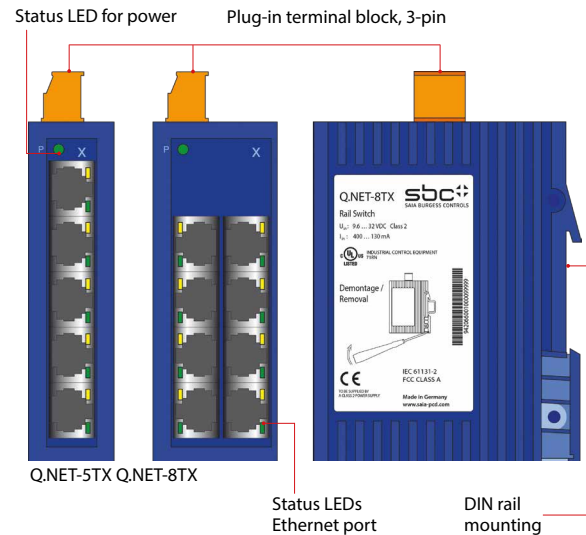

Technical data Q.NET-5TX and Q.NET-8TX

Operation	
Port type and number	Ethernet 10/100 MBit/s, 5× RJ45 (Q.NET-5TX) or 8× RJ45 (Q.NET-8TX)
Network line lengths	Twisted pair (TP), 0...100 m
Network cascade depth	Linear/star structure – any depth
Operating voltage	9.6 VDC...32.0 VDC
Current draw at 24 VDC	max. 100 mA
Displays/diagnostics	1× green LED; power 5× / 8× yellow LED; data rate 5× / 8× green LED; data, link status
Environmental conditions	
Operating temperature	0°C ... +60°C
Storage temperature	-40°C ... +70°C
Humidity	up to 95% (non-condensing)
Standards/approvals	
EMC noise immunity:	EN 61000-4
EMC noise emission:	EN 55022 Class A, FCC CFR47 Part 15 Class A
Safety for Industrial Control Equipment	cUL508, CSA22.2 No. 142, E 175531
Mechanical stability	IEC 60068-2 (shock, vibration)
Protection type	IP30
Order details	
Q.NET-5TX	5-port rail switch, terminal block, patch cable and operating instructions
Q.NET-8TX	8-port rail switch, terminal block, patch cable and operating instructions

Connection options

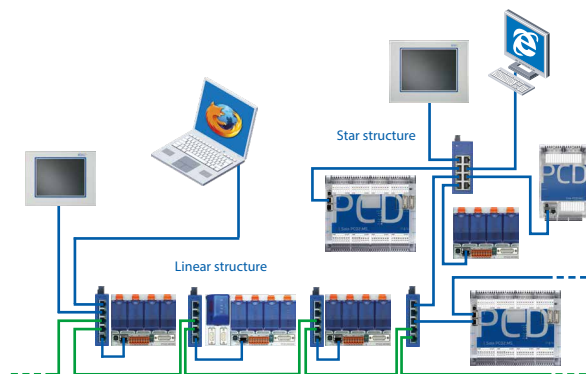

Dimensions

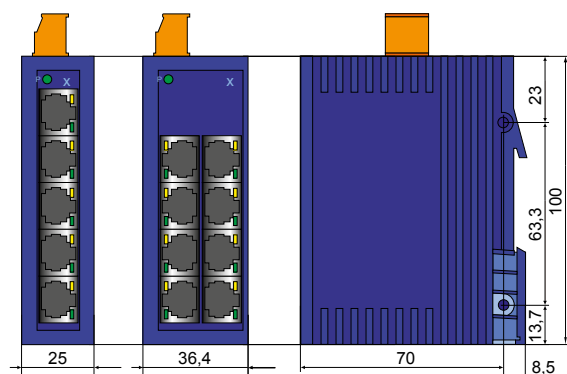

5.5 RS-485 bus termination box PCD7.T16x

The PCD7.T16x termination boxes are used for RS-485 network termination. Each RS-485 network segment must be terminated at the end of the network. The PCD7.T16x termination boxes ensure that the RS-485 signals are set at the correct signal level and the integrated 120 Ohm resistor prevents signal reflection in the RS-485 cable. With their robust and compact construction and electrically isolated power supply with either 230 VAC or 24 VAC/DC, the PCD7.T16x termination boxes are suitable for use in harsh industrial environments and in infrastructure automation. An LED indicates the presence of the supply voltage of the PCD7.T16x termination box.

System properties

- ▶ 35 mm DIN rail mounting
- ▶ 17.5 mm wide housing
- ▶ 230 VAC +15% /-20% for PCD7.T161
- ▶ 24 VAC / DC -15% /+15% for PCD7.T162
- ▶ Current consumption of 0.4 W
- ▶ Electrically isolated power supply
- ▶ Fixed-line terminator resistance of 120 Ω
- ▶ LED operating indicator

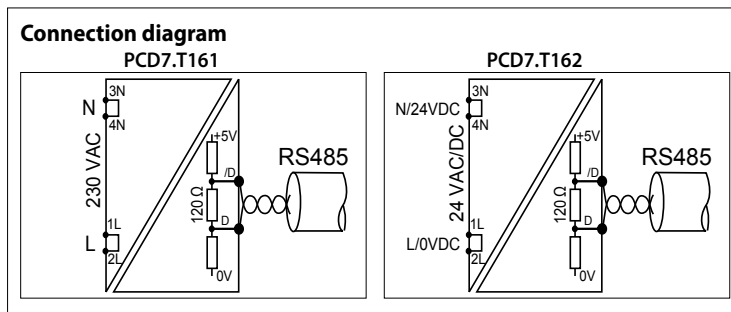

Dimensions

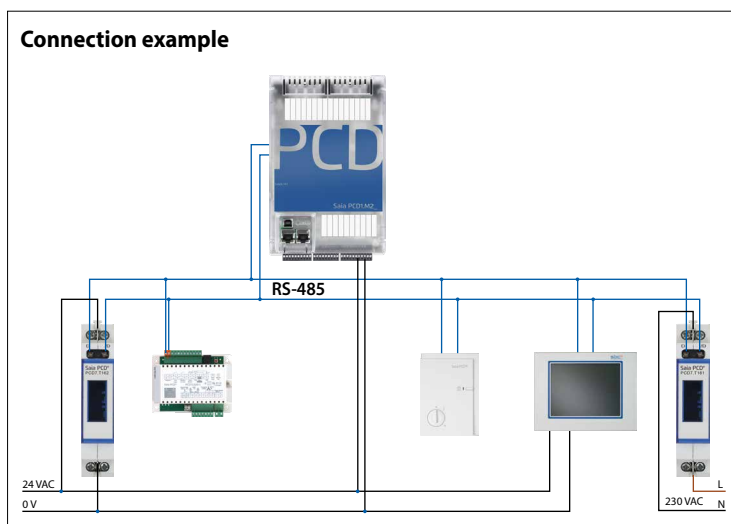
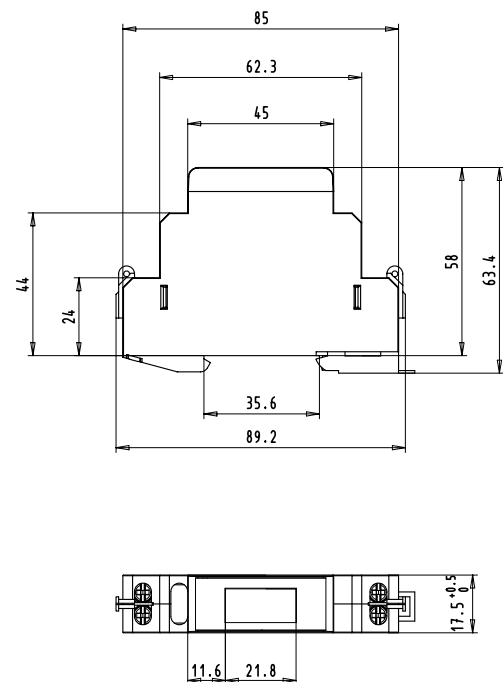

	PCD7.T161	PCD7.T162	Comments
Power supply	230 VAC	24 VAC / DC	
Housing	17.5 × 85 × 64 mm	17.5 × 85 × 64 mm	PCD7.T161 and PCD7.T162 comply with the standards for switch cabinets
Terminating resistor	Fixed 120 Ω	Fixed 120 Ω	
Display	LED for 230 VAC	LED for 24 V	

Lead sealing cap as an accessory, see section 4.2.6 (ALD1)

5.6 Interface modules with local override to control drives, valves or flap systems

Dimensions

PCD7.L252/452

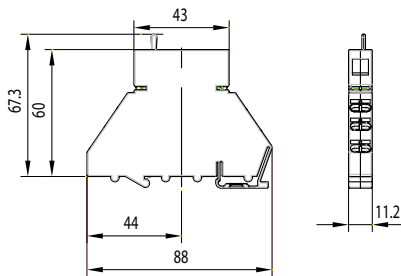

PCD7.L252:

Coupler modules with manual operating level Auto/OFF/ON

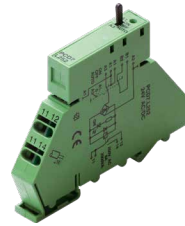

- ▶ 1 changeover contact
- ▶ Local override operation
- ▶ Auto acknowledge
- ▶ LED display
- ▶ Test contacts for each terminal
- ▶ Spring terminals (push-in)

PCD7.L452:

Analogue value transmitter for manual correcting variables

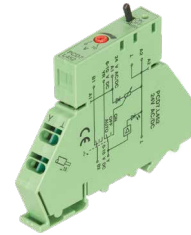

- ▶ Potentiometer 0...10 V
- ▶ Local override operation
- ▶ Auto acknowledge
- ▶ LED brightness in proportion to control variable
- ▶ Test contacts for each terminal
- ▶ Spring terminals (push-in)

Single-stage coupler component with local override operation, acknowledgement of switch position and an LED for status indication. Coupler modules are used for safe potential isolation between logic and load. Spring terminals allow for quick and easy wire connection. The supply voltage can be connected across jumpers using additional terminals with no wiring or additional time required.

The analogue data encoder is used as a variable encoder for manual variable specification, e. g. mixing valves, valve positions, temperature values, etc. It has three operating modes: ON, OFF and AUTO. In switch position AUTO, the control variable will be looped unchanged via the YR terminal to the control variable output Y. In switch position ON, the control variable can be set using the potentiometer on the front of the device. The output signal will be available at terminal Y.

Input side	PCD7.L252	PCD7.L452
Supply voltage	24 VDC/VAC, -15%/+10%	24 VDC/VAC, -15%/+20%
Current draw	13 mA, protection wiring with recovery diode	19 mA at 24 VDC 30 mA at 24 VAC
Input current	---	2 mA at 10 VDC (input YR)
Response / release time	10 ms/5 ms	---/---
Input voltage	24 VDC/VAC	0...10 VDC
Operating indicator	Green LED to indicate relay state	Red LED (brightness in proportion to control variable)
Output side		
Output contact	1 changeover	---
Turn-on voltage	max. 250 VDC/VAC	---
On/off switching current	max. 8 A	---/---
Output voltage	---	0...10 VDC, 10 mA, output Y in switch position Auto/ON
Continuous current	8 A	---
Breaking capacity (ohmic load)	24 VDC/180 W 50 VDC/65 W 230 VDC/50 W 250 VAC/2000 VA	---
Breaking capacity min.	24 VDC/20 mA	---
Service life		
mechanical	2 × 10 ⁷ switch cycles	---
electrical (at maximum switching load)	1 × 10 ⁵ hystereses	---
Switching frequency	MAX: 300 hystereses / h at max. current	---

Accessories

PCD7.L291	Jumper for connection of the supply voltage of up to 10 PCD7.L252 and PCD7.L452 modules
PCD7.L490	Labelling plate for PCD7.L452 (in packs of 10)
PCD7.L290	Labelling plate for PCD7.L252 (in packs of 10)

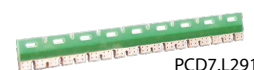

PCD7.L291



PCD7.L490 / PCD7.L290

5.7 I/O module integration into switch cabinet

Pre-assembled system cables and terminal adapter modules support the fast integration of the integration of the Saia PCD I/O modules into the switch cabinet. I/O modules with ribbon connections, in particular, can be installed quickly and easily in the switch cabinet. The modules with terminals can also be connected to the adapters using traditional stranded wires. The adapters either are available for galvanic separation of the outputs with relays or as simple I/O adapters with voltage distribution.

System properties

- ▶ Available as I/O terminal adapter or relay interface
- ▶ Relay interface with manual mode
- ▶ Compatible with Saia PCD2 and PCD3 systems
- ▶ For connection with system cable or stranded wire
- ▶ For DIN rail mounting



Pluggable ribbon cables with connector at the Saia PCD end

Cable for the digital modules with 16 inputs/outputs

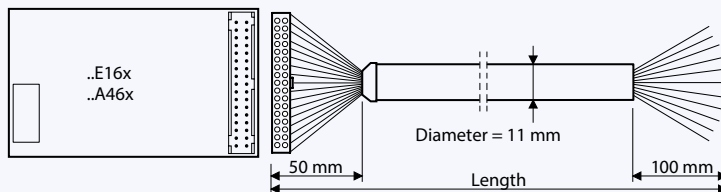

PCD2.K221/K223 cable

Sheathed, round cable with 32 strands of 0.25 mm² (AWG 24), 34-pin ribbon connector at the PCD end
Free, unshielded 100 mm ends at the process end
Stranded wires, colour-coded
Cable length PCD2.K221 = 1.5 m
PCD2.K223 = 3.0 m

Terminal adapter for digital inputs/outputs

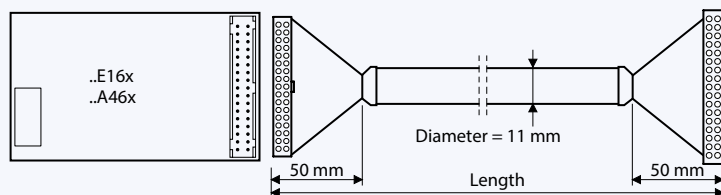

PCD2.K231/K232 cable

Sheathed, round ribbon cable with 34 strands of 0.09 mm², 34-pin ribbon connector at both ends
Cable length PCD2.K231 = 1.0 m
PCD2.K232 = 2.0 m

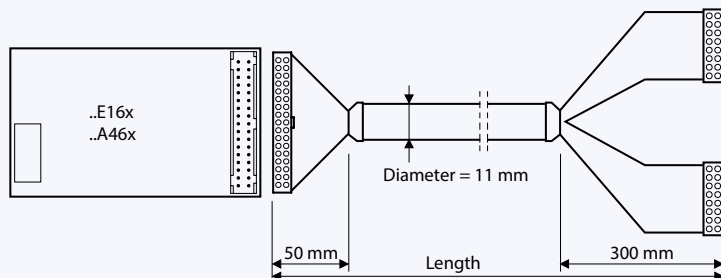

PCD2.K241/K242 cable

Sheathed, round ribbon cable with 34 strands of 0.09 mm², 34-pin ribbon connector at the PCD end
Process end divided into 2 branches, each 300 mm in length, leading to 16-pin ribbon connectors
Cable length PCD2.K241 = 1.0 m
PCD2.K242 = 2.0 m

To facilitate and speed up the installation of controllers, various adapters are available that can be connected direct to the Saia PCD I/O modules via system cables. Apart from terminal adapters, there are also relay interfaces available which enable simple galvanic separation. The relay interfaces can be connected with ribbon cables or with stranded wires.



Terminator adapter for I/O modules with ribbon connection

Mechanical design

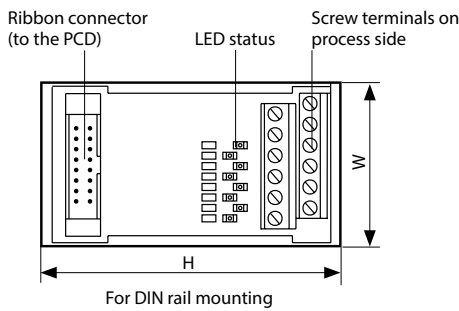

Terminal adapter for 16 inputs/outputs

Terminal adapter PCD2.K520/K521
 34-pin ribbon connector at the PCD end
 Process end 2x10 screw terminals 0.5...1.5 mm²
 PCD2.K520 without LEDs
 PCD2.K521 with LEDs (source operation)

Dimensions: 65 x 82 x 60 mm (W x H x D)

Terminal adapter for 16 inputs/outputs

Terminal adapter PCD2.K525
 34-pin ribbon connector at the PCD end
 Process end 3 x 16
 Screw terminals 0.5...1.5 mm² with LEDs (source operation)

Dimensions: 94 x 82 x 72 mm (W x H x D)

Adapter relay interface

Relay interface PCD2.K551
 for 8 PCD transistor outputs with 24 screw terminals and LED
 Switching capacity of the changeover contacts
 10 A/250 VAC or 10 A/24 VDC (ohmic), 24 VDC spool
 16-pin ribbon connector or screw terminals at the PCD end
 24 screw terminals 0.5...1.5 mm² at the process end

Mechanical data
 Diameter of the screw terminals: M 2.6 mm
 Starting torque: 0.4 Nm

Dimensions: 128 x 82 x 55 mm (W x H x D)

Adapter relay interface with manual operation

Relay interface PCD2.K552
 for 8 PCD transistor outputs with 24 screw terminals, LED and manual operation mode (switch on-off-auto) and 1 output as feedback for the manual mode
 Switching capacity of the changeover contacts 10 A/250 VAC or 10 A/24 VDC (ohmic), 24 VDC spool
 16-pin ribbon connector or screw terminals at the PCD end
 24 screw terminals 0.5...1.5 mm² at the process end

Mechanical data
 Diameter of the screw terminals: M 2.6 mm
 Starting torque: 0.4 Nm

Dimensions: 128 x 82 x 44 mm (W x H x D)

B

Basic systems

B1	SBC Software	153
B2	Communication & Interaction	187
B3	SBC S-Web technology	217
B4	Room automation	237

B1 SBC Software

Saia PG5® Controls Suite contains everything required to realise and operate automation solutions with MSR devices. This includes programming and engineering tools as well as libraries and turnkey logic, regulation and automation modules. It also comes with an application software for Windows PCs.



PC-Tools



Application components



Application software

1.1 Saia PG5® Controls Suite: Engineering & programming

Page 154

1.1.1	Saia PG5® Core – everything you need, available at all times	
1.1.1.1	Saia PG5® Core Basic properties Functions and applications of the Saia PG5® Core What is the licence policy and what about software maintenance	154
1.1.1.2	Saia PG5® Core Components Presentation of the individual components and overview of the Saia PG5® Core.	157
1.1.2	Saia PG5® HVAC modules	
1.1.2.1	HVAC library The HVAC library simplifies the engineering of technical systems for buildings.	164
1.1.3	Increase in engineering efficiency through SBC system template	
1.1.3.1	DDC Suite Reduce engineering time with DDC Suite and web templates.	165
1.1.4	Saia PG5® Controls Suite	
1.1.4.1	My Controls Suite Create your own templates or FBoxes with Saia PG5® FBox Builder for a perfect fit with your applications and workflow	168
1.1.4.2	Overview of the tools and licence packages Better understanding and overview of the engineering and programming tools. From a wide range of software combinations, 3 packages are defined for the global standard.	170

1.2 Application software for Windows PCs

1.2.1	Saia PCD® Supervisor	
1.2.1.1	Saia PCD® Supervisor The complete solution for intelligently managing buildings and infrastructures.	173
1.2.1.2	Saia PCD® Supervisor EM Complete solution for energy management in the Saia PCD Supervisor.	182
1.2.2	SBC OPC Server	185
	Industrial bus systems and protocols provide universal communication capabilities.	
1.2.3	SBC Network tools	186
	BACnet explorer software for professional analysis and diagnostics of building automation networks.	

1.1 Saia PG5® Controls Suite: Engineering & programming

1.1.1 Saia PG5® Core – everything you need at all times

The Saia PG5® Core is central key element of Saia PG5® Controls Suite. It is used to create Saia PCD® projects. The Saia PG5® Core is included in every software package and it is identical throughout.

1.1.1.1 Saia PG5® Core | Basic properties

Wide range for large and complex projects



Saia PG5® Project Manager enables users to manage projects with a single set of controls or very large networks.

OEM manufacturers can use it with just one Saia PCD® per machine, just as it can be used for large properties such as tunnels with over a thousand installed Saia PCD® controllers.

◀ The Saia PG5® Project Manager for individual devices and large control networks.

Software tool with broad user profile – all users can quickly master it

Saia PG5® Core provides to all groups of persons involved in MSR and automation technology suitable functions for performing tasks reliably and well.

As an application engineering tool, users can also implement the most demanding automation projects using graphic application modules in the Fupla Editor without requiring programming in IL, Graftec or Kopla, etc.

As a development tool, dedicated control and logic functions, communication drivers and IT functions can be programmed in the Instructions List.

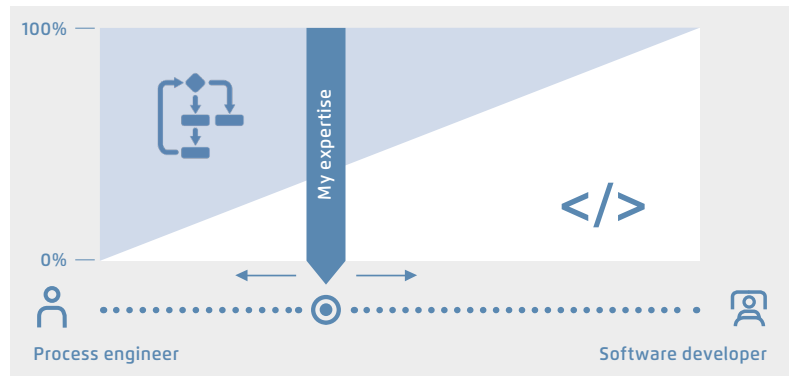

▲ Saia PG5® offers a wide range of solutions, the right product for everyone

The training program by Saia-Burgess Controls AG

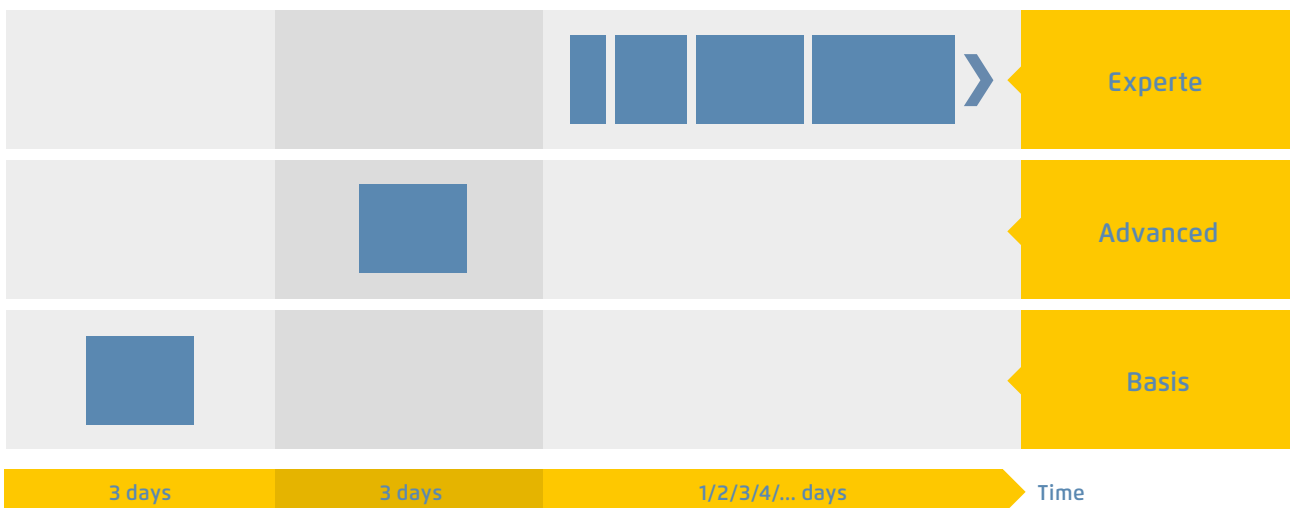

▲ The time required to achieve solution competence

A standardised software – for all device types – now and in the future

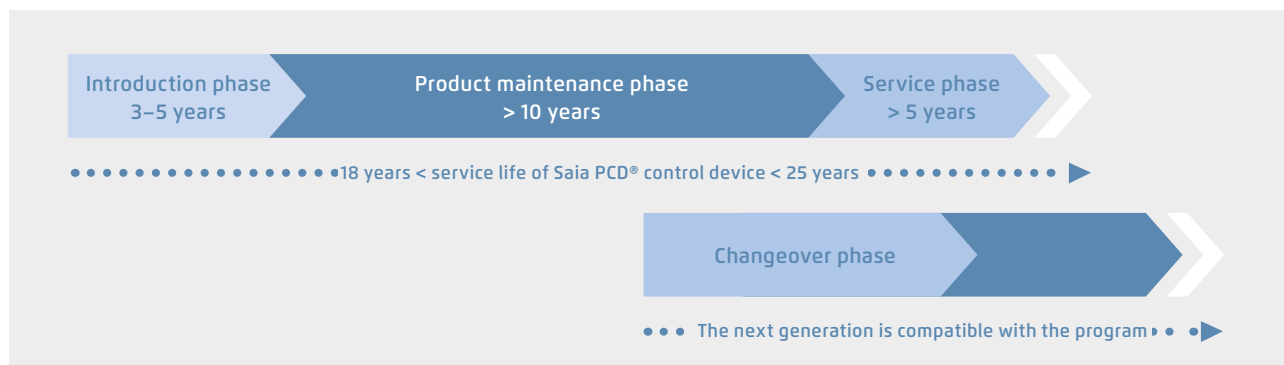

▲ Service life planning of Saia PCD® control devices. Enables maximum profitability of your investment in expertise and systems. Long service life without expensive reinvestment and no high service costs.

The control electronics should have the same service life as the systems technology. It must be possible to adapt and expand at any point in this cycle.

The compatibility and free portability of systems/machine software is guaranteed for 18–25 years across the entire

product generation. This can only be achieved if we develop all the engineering software ourselves and systematically use "interpreted program code". This requires more hardware resources, but enables the portability of user software across multiple generations of controllers.

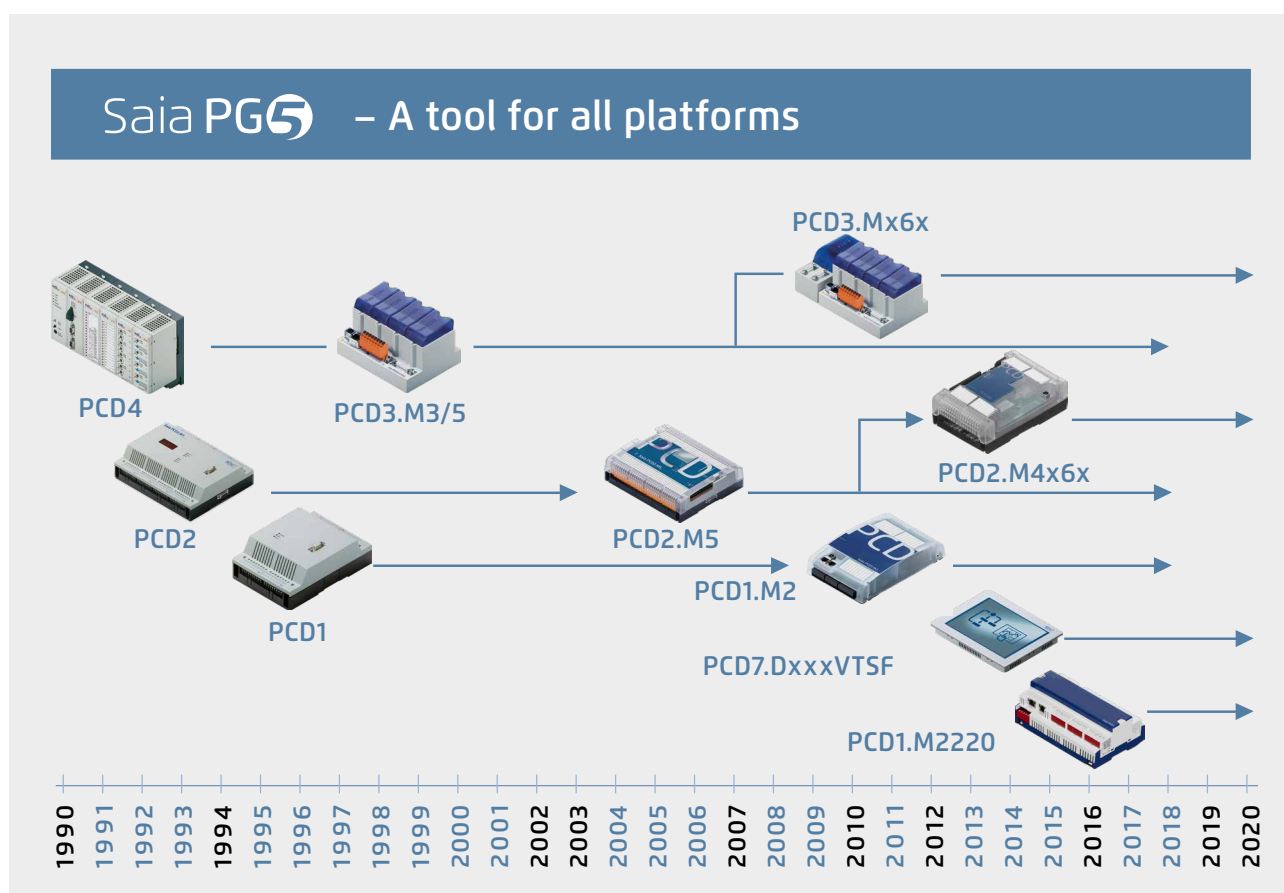

▲ Old application programs can be used with new Saia PCD® controllers and further edited with Saia PG5® Core

Licence policy for maximum security, flexibility and independence



- ▶ In principle, any company can acquire the licence for Saia PG5®. There are no market-related exclusions as is the case with other providers. The only requirement is the ability to implement the products professionally.
- ▶ With the acquisition of a Saia PG5® licence, a company can register any number of its employees as users. There are no costs per place or per user. However, a company must at least have verifiably one qualified Saia PG5® programmer. The qualification can be obtained via training by SBC.
- ▶ There is a special end user licence for operators of Saia PCD® automation systems. This includes all SBC software tools and SBC application libraries which an external service provider or OEM has used in a system/property to create an automation system. The end user licence only applies to the Saia PCD® devices installed by the operator and cannot be used to develop automation solutions for third parties.

◀ This certification as Saia PCD® system integrator demonstrates that a company can verifiably implement automation solutions in a reliable and professional manner with Saia PCD®. We recommend that operators, investors and planners consider certification when selecting service providers.

USER · KEY
KEY-Datei
1KB



Licence as a "user key"

Licensing procedure

The Saia PG5® licence mechanism offers more flexibility and simplicity when installing licence expansions. The licence is distributed as a "user key" file which defines the user's permission for the software applications. A licence expansion can be quickly assigned by sending the customer an e-mail with a "user key" file or a *password*.

SBC can create customer-specific user keys using the licence manager. The keys can be tailored to any requests. It is possible to define editors or libraries which the customer is authorised to use. The scope, number and size of the projects are irrelevant here.

Software maintenance

We are continually advancing our software in logical and easy-to-manage innovation steps. The following diagram shows the major version changes over the past 15 years. Patches are used to manage identified errors. Version changes are not required. New functions are first tested in beta versions before the sum of all the new functions is made official in a major new version. A moderate fee is charged for major version steps with substantial additional functions. This happens every 2 to 3 years.

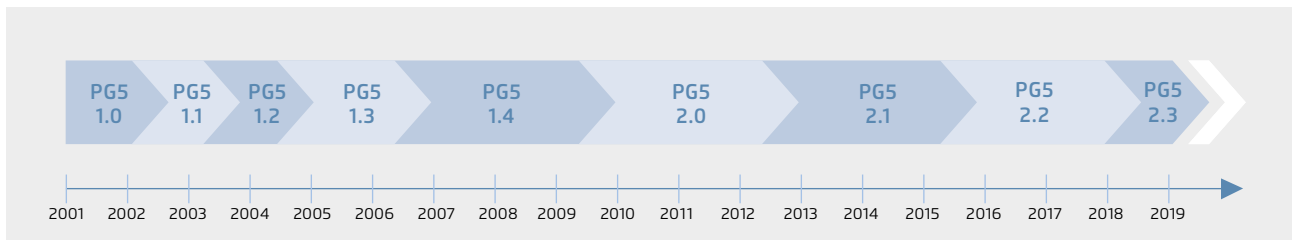

▲ Milestones in software development and maintenance

1.1.1.2 Saia PG5® Core | Components

The following pages illustrate Saia PG5® Core and explain the components individually in detail.

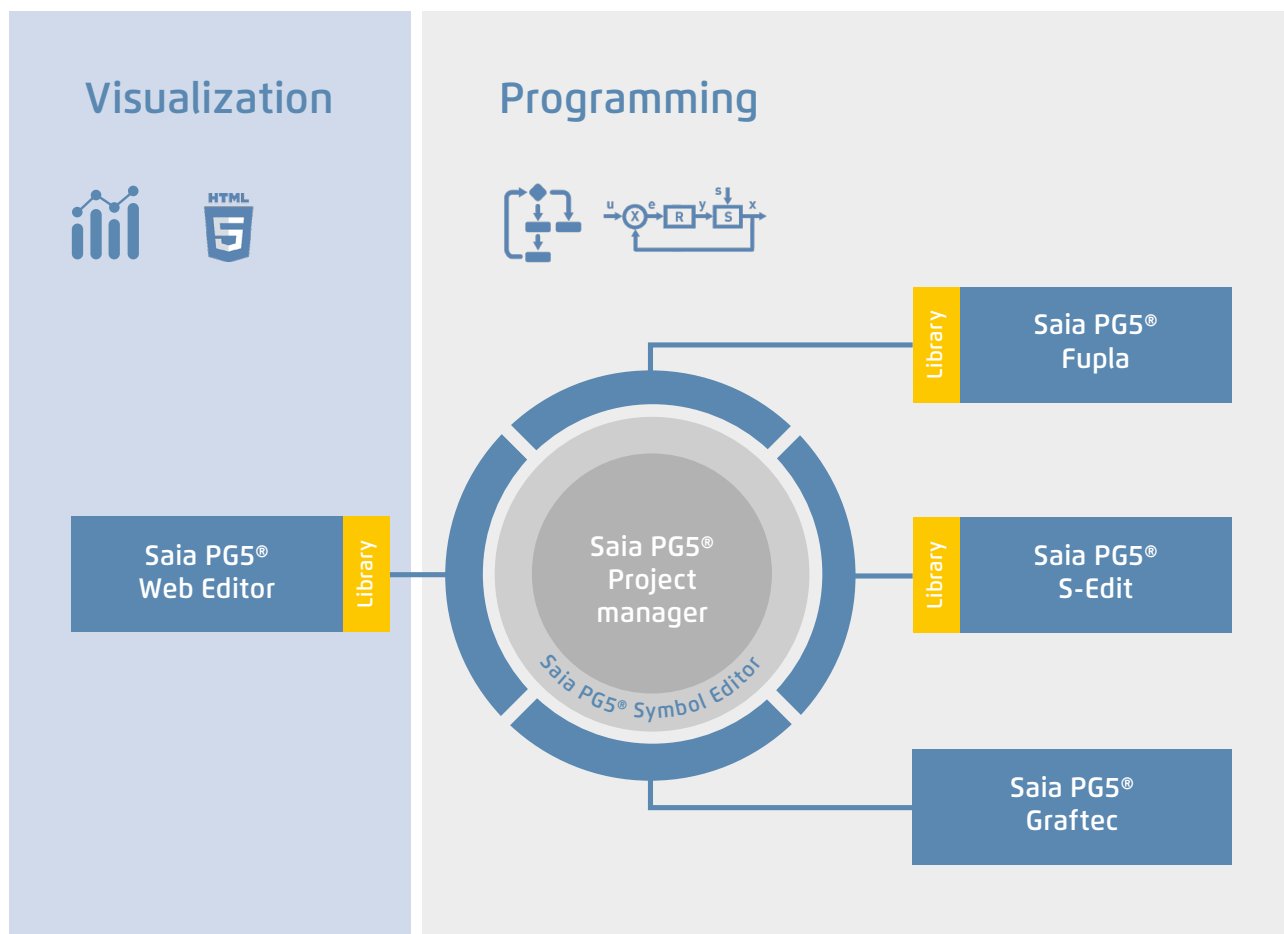

Saia PG5® Core in a nutshell

Saia PG5® Core contains the following components

- ▶ Project Manager (manages complex installations of networked Saia PCD® controllers including documentation)
- ▶ Network Configurator (integrated network editors for the configuration of devices and communications networks)
- ▶ Device Configurator (configuration of hardware parameters on the controller)
- ▶ Symbol Editor (manages all local, global and network symbols and symbol groups. Thanks to the automatic allocation, no fixed addressing is needed)
- ▶ Programming methods (integrated programming environments: Fupla [function block diagram], S-Edit [instruction list IL] and Graftec [flowchart])
- ▶ Libs (standard libraries which quickly and easily enable all the core functions of the MSR/automation technology)
- ▶ Web Editor (for WebSCADA functions in each controller)

Saia PG5® Project Manager

The configurations and applications are created, changed and managed in Saia PG5® Project Manager. Saia PG5® Project Manager is pivotal for all tasks with Saia PCD® controllers.

The following window appears on the left edge of the screen as soon as Saia PG5® Project Manager is opened. With desktop docking, there is still enough space on the right of the screen for additional windows.

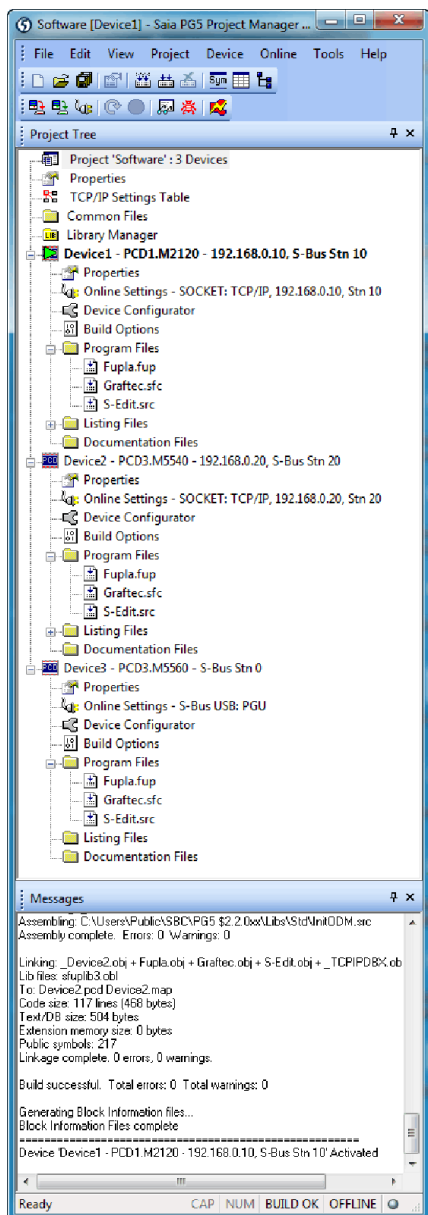

Window of Saia PG5® Project Manager

Project Tree

The layout and structure largely correspond to Windows Explorer. The "Project Tree" window allows direct access to all Saia PCD's used in the project and their relevant settings, program files and documents. Program organisation by files (containing one or more program blocks) simplifies the shared use of program files in multiple Saia PCD's.

The "Program Files" folder can consist of different data types. Therefore, it is possible to save all types of programming in one folder.

Messages and Error List

Error and status messages are displayed in this window along with the assembly protocol. Errors in the program code are listed here after assembly, and can be located directly by clicking.

Network Configuration

Network configuration is used for the configuration of devices and communications networks. **There are three different basic configurations:**

1. Ethernet RIO Network Configurator

▶ Smart RIO – PCD3.T665 and PCD3.T666

2. BACnet Network Configurator

▶ BACnet Configuration Files (*.bnt)

3. S-Net Network Configurator

▶ Profibus DP Network File (*.dp)

▶ Profi S-IO Network File (*.sio)

Device Configurator

The hardware and physical functions of the controller are defined in the Device Configurator; e.g. device type, memory modules, communication channels, associated modules and I/Os. The I/O configuration, parameterisation and designation, as well as the configuration of the Ethernet protocols, e.g. DNS, DHCP, etc. takes place here. The Device Configurator also controls the use of input/output modules in the internal power supply of PCDs and prints the labels which are placed on the I/O modules.

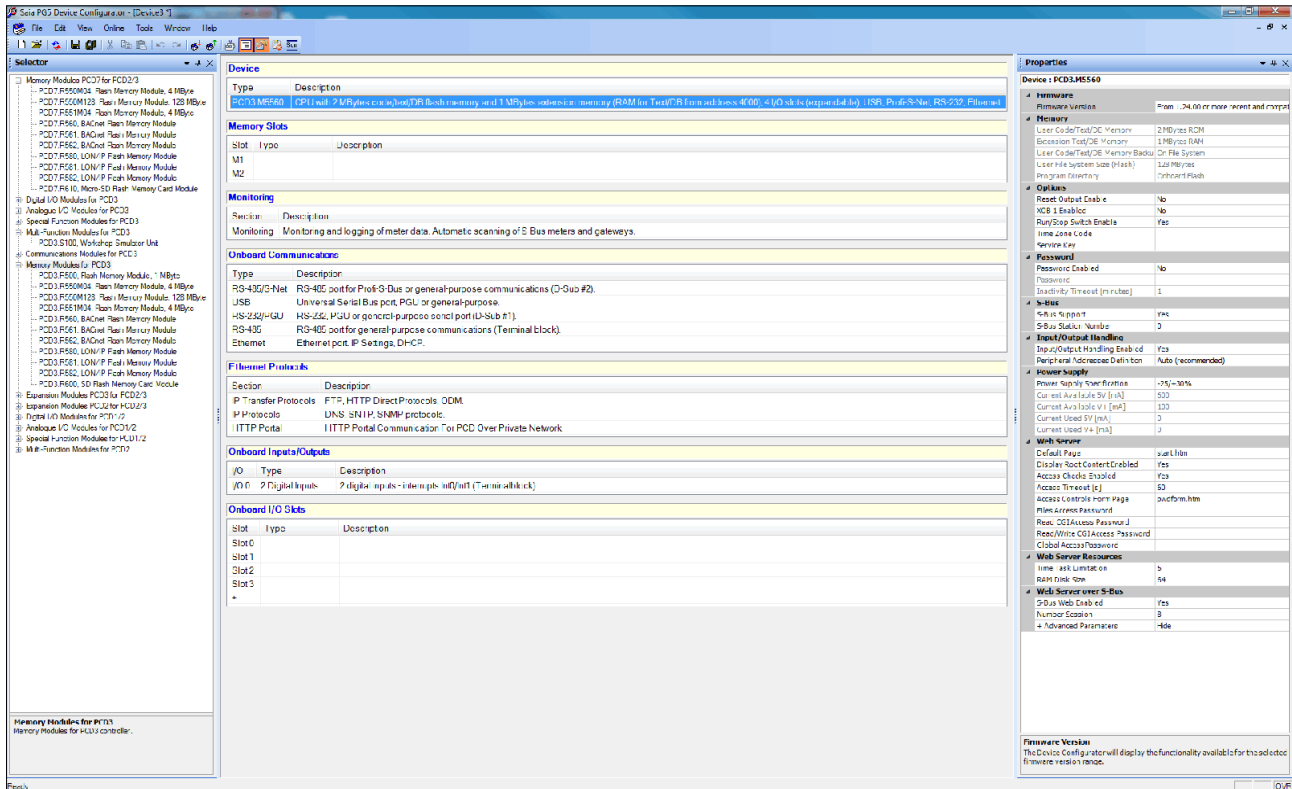

All parameters and modules can be viewed at a glance and printed out as system documentation in the Device Configurator

Symbol Editor

The Symbol Editor is the heart of Saia PG5® Core. It defines and documents all the symbols used by the program. The various editors are connected with the Symbol Editor. New symbols used in the program code are incorporated directly by the Symbol Editor.

- ▶ The import/export function allows the reuse of pre-defined I/O lists in electrical diagrams and visualisation tools.
- ▶ Symbols can be grouped together. All the symbols required for a function form one group. This makes it easier to use functions and recognise symbols in the program code, and also gives a clearer overview in the Symbol Editor.

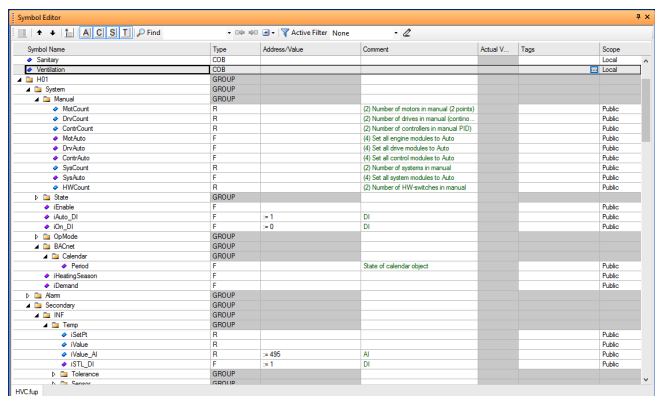

Overview of all symbols used in the Symbol Editor

Programming methods in the Saia PG5® Core

Saia PG5® Fupla (function block diagram)

Fupla is the SBC proprietary function block diagram editor. It differs in many respects from other graphic programming interfaces:

- ▶ One Fupla file may contain several program blocks. This means that one file can encompass an entire machine function. In symbolic programming, each program block is given an individual symbol name. This prevents collisions during the build.
- ▶ Fupla blocks are organised into pages. Each page can produce several outputs so that entire functions can be viewed at a glance on one page.
- ▶ Graphic functions (FBoxes) not only have inputs and outputs, but also parameter windows for configuration and online modification.

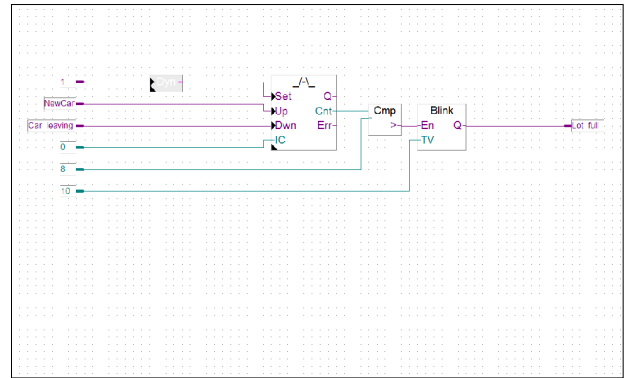

Saia PG5® Fupla (function block diagram)

Comment:

The Kopla Editor (contact plan) is an integral part of Saia PG5® Fupla Editor. Unlike conventional graphic programming environments, FBoxes and contact plan elements can be combined in a single graphic.

Saia PG5® Graftec (sequential function chart)

Graftec (sequential function chart) is particularly suited to sequential processes. Sequential blocks are a fixed component of the PCD firmware and are processed by it efficiently.

- ▶ Steps and transitions can be programmed in IL and graphically in Fupla.
- ▶ To also ensure a good overview with extensive sequential processes, division into sub-pages is possible.
- ▶ In online mode, the active transition is permanently displayed.
- ▶ Option to process the code step-by-step in step mode.

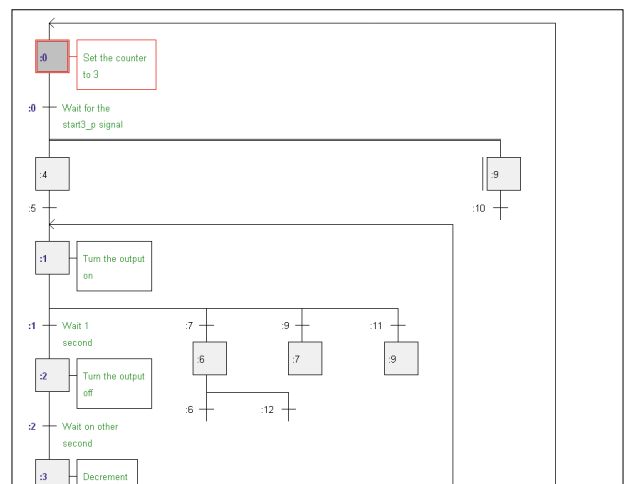

Saia PG5® Graftec (sequential function chart)

Saia PG5® S-Edit (instruction list IL)

The editor for the strong instruction set of Saia PCD®. S-Edit combines an editor and online debugger in one interface.

- ▶ The colour syntax function detects valid instructions and applies a colour to them. The program code is thus much easier to read and typographic errors are detected immediately.
- ▶ The "Bookmarks", "Goto Line", "Find and Replace" editor functions make it easier to navigate through extensive programs.
- ▶ The code built can be displayed directly in the original code. The function is also used by the integrated debugger.
- ▶ Complete functions can be copied from a library using drag & drop.

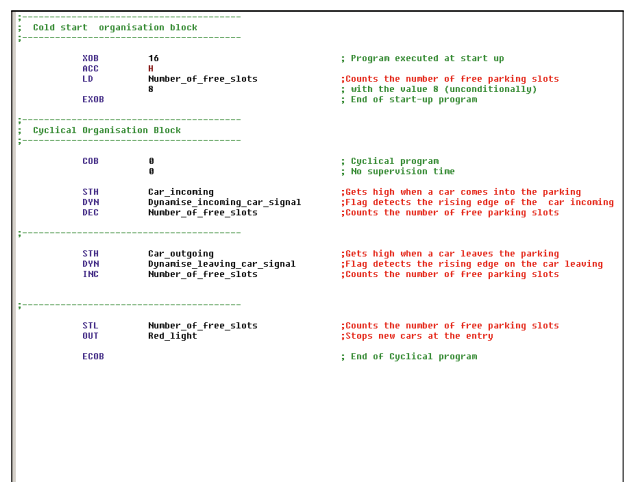

Saia PG5® S-Edit (instruction list IL)

Saia PG5® Fupla

The Saia PG5® Fupla Editor is the quickest and most reliable method of implementing applications. This editor can also be easily used by those with no software programming experience. It is the right tool for optimising and modifying systems. All complex functions have been implemented by specialists in Saia PG5® S-Edit or Saia PG5® Graftec and packaged into graphic function blocks (FBoxes).

"Ready and simple to use" also by service technicians and process engineers. >95% of all applications can be implemented in the automation infrastructure through engineering using Saia PG5® Fupla alone. No line of code is written here.

Benefits of using the Fupla Editor

- ▶ Programming is facilitated with pre-programmed function blocks (FBoxes) for all standard functions
- ▶ Creation of complex user programs by simply positioning and linking FBoxes without requiring extensive programming knowledge.
- ▶ Extensive and high-performance FBox families for communication and building automation tasks
- ▶ Detailed context-sensitive FBox information, clear parameter descriptions and graphic presentation in the function block diagram editor (Fupla) make user programs easy to read and understand
- ▶ Online display of process values and parameter adjustment makes commissioning considerably easier and saves maintenance costs

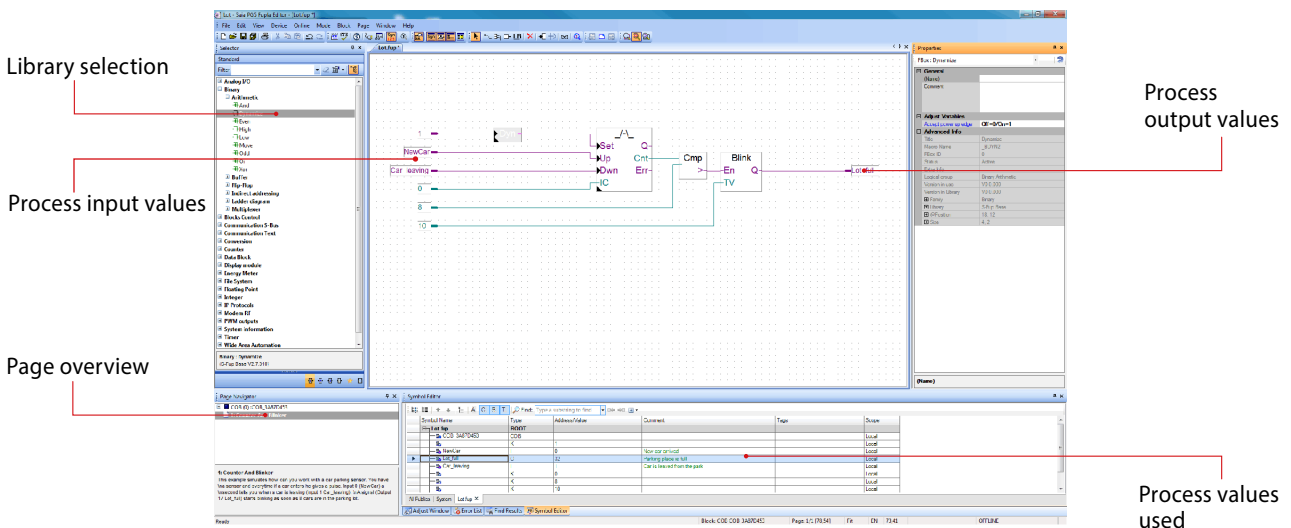

Structure of the Fupla Editor

Features of the libraries

- ▶ The clearly arranged tree structure simplifies FBox selection.
- ▶ Parameters are conveniently entered via adjust windows in the Fupla editor, without losing the program overview
- ▶ Obvious differentiation between data types by using different colours





Each data type is identified by a colour. This makes programs easier to read.

- Binary data
- Integer data
- Floating point data
- Texts (TX) and data blocks (DB)



Clear grouping into families

All FBoxes (function boxes) are grouped into families. This provides a better overview and makes it easier to find individual FBoxes. A distinction is also made between standard, application and user FBox:

-  Standard: Shows the FBox libraries of the basic application components
-  Application: Shows the FBox libraries of the engineering application components
-  User: Only shows the FBox libraries which the user himself has created
-  All: Shows all available FBox libraries
-  Favourites: On this page the user can group together the most frequently used FBoxes (from all libraries). This means that it is no longer necessary to search for FBoxes or to switch between library tabs.

FBoxes in the Saia PG5® Core

The standard and application FBoxes are readily available for users in the Saia PG5® Core.

The standard FBox libraries are basic families which offer normal logical and arithmetic operations and numerous useful system functions.

In addition to the standard FBoxes, the Saia PG5® Core contains additional FBoxes. These include application FBox libraries which comprise engineering families.

The search function (Filter) in the Selector enables a specific FBox to be found quickly.

So that Engineering can access the correct FBoxes, their function and parameters must be known. The online user manual integrated into the PG5 Core is the ideal way to get a quick overview of the relevant FBoxes.

Clicking on the FBox makes information such as a brief description of the FBox, an explanation of inputs and outputs, information on the parameter settings and a function description of the FBox accessible to all.

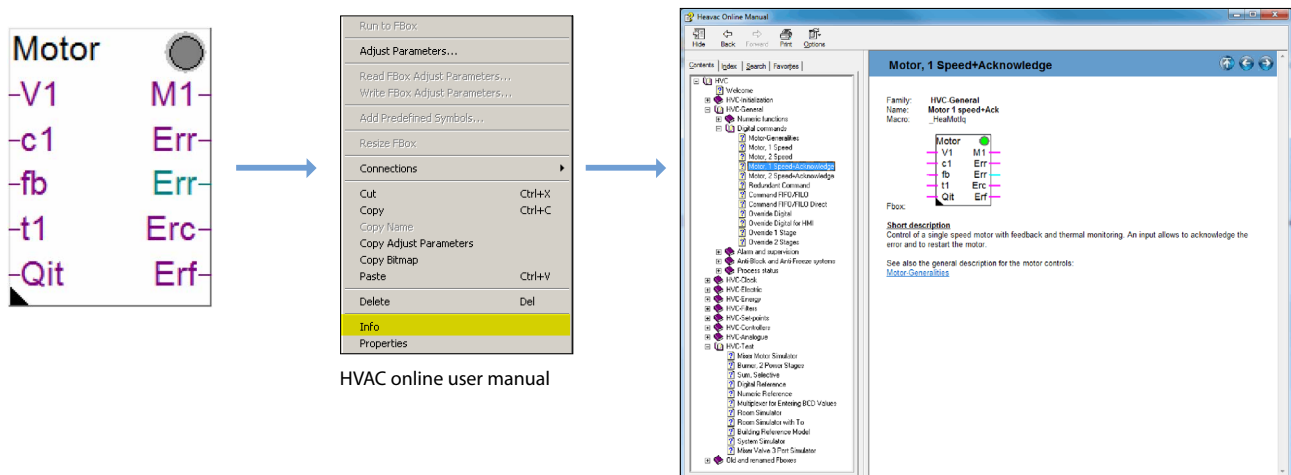

The diagram illustrates the process of accessing detailed information for a specific FBox. It starts with a 'Motor' FBox symbol on the left, which has inputs V1, c1, fb, t1, Qit and outputs M1, Err, Err, Erc, Erf. An arrow points to a context menu for the FBox, listing actions such as 'Run to FBox', 'Adjust Parameters...', 'Connections', 'Cut', 'Copy', 'Copy Name', 'Copy Adjust Parameters', 'Copy Bitmap', 'Paste', 'Delete', 'Info', and 'Properties'. A second arrow points to the 'HVAC online user manual' interface. The manual shows a tree view on the left with 'Motor, 1 Speed+Acknowledge' selected. The main panel displays the FBox symbol, its family (HVC-General), name (Motor, 1 Speed+Ack), macro (_HeatMolig), and a 'Short description' of its function: 'Control of a single speed motor with feedback and thermal monitoring. An input allows to acknowledge the error and to restart the motor.' A link to 'Motor-GeneralInfo' is also provided.

Web Editor – a powerful software tool

The production of web-based visualisation and control interfaces is an essential element of the engineering effort. Appealing, functionally designed web pages are the public face of the system, supporting operational efficiency and safety. A powerful tool for generating the web pages is therefore crucial.



Start screen for Saia PG5® Web Editor 8

Saia PG5® Web Editor: simple, intuitive and efficient

Designing dynamic web pages with a normal HTML editor is laborious and requires specific expertise (in-depth HTML and Java programming knowledge). With the Saia PG5® Web Editor, SBC provides the user with an easy-to-use software tool for generating web pages to ensure that this innovative technology does not remain the preserve of a small number of specialists. The Web Editor is used to create web pages in HTML5 or in TEQ-format simply and efficiently by placing and parameterising objects. Operation of the editor is intuitive, and requires no HTML or Java programming knowledge. With optimum integration into the Saia PG5® Controls Suite and the associated direct access to all symbols, powerful macro management to generate your own reusable macros and many other useful functions for efficient generation of web pages, the engineering costs are significantly reduced compared to other editors.

The tool is designed for the automation environment. Applications include system visualisations, alarming and trending functions, or just one service page. The full integration into the Saia PG5® Core combined with Saia PCD® controllers guarantees a particularly efficient working method.

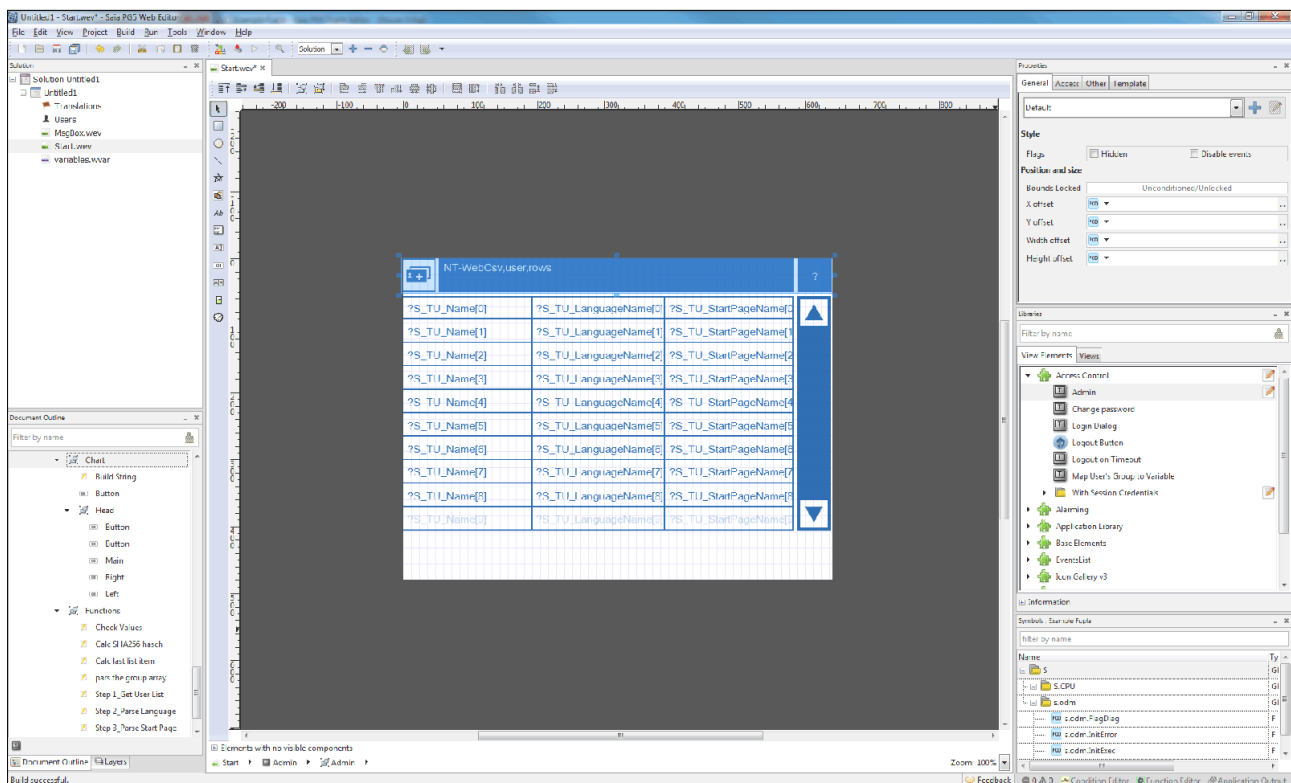

The Saia PG5® Web Editor produces appealing web visualisations with no web designer skills required.

The Web Editor includes a transparent and adjustable workspace for efficient operation. The workspace essentially comprises the menu/command bar, the View Editor (drawing area) and windows. With docking window technology, the user can position and show/hide the windows as required.

1.1.2 Saia PG5® HVAC modules

1.1.2.1 HVAC library

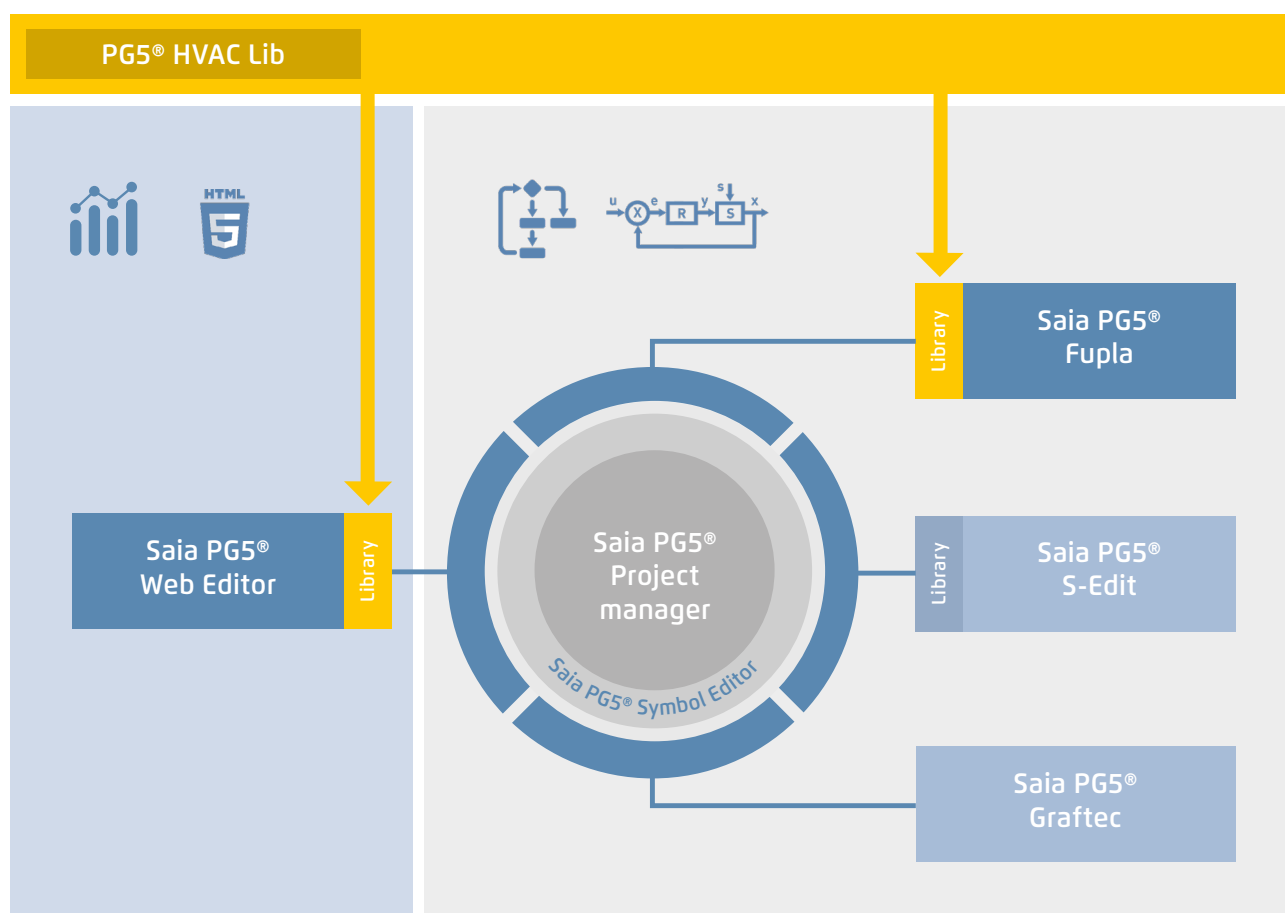

Saia PG5® Core + HVAC library. The visualisation is created using the Web Editor.

The majority of the program functions can be implemented using the FBoxes included the Saia PG5® Core Package. In addition, additional libraries for specific applications are available. The HVAC library, for example, has an efficient collection of complex control modules (FBoxes) for the heating, ventilation and air conditioning systems area. These functions simplify the engineering of the technical systems of buildings.

The HVAC library contains the following FBox groups

- ▶ General: FBoxes for numeric functions, binary functions, alarms, monitoring, motor, blocking and frost protection, process states, switches and the conversion of data types
- ▶ Analog: Function blocks for individual scaling of each individual analog input or output
- ▶ Electrical: FBoxes for lighting control, window blind control and step switches
- ▶ Energy: Energy meters, pulse counters, monthly statement, enthalpy, switching heating on/off, load cut-out
- ▶ Filters: Filter, limitation, ramp limitation, average of measurement values, dead zone, dead range with delay, zero zone, hysteresis
- ▶ Init: Initialisation of the sub-functions for the HVAC library
- ▶ Controllers: Two-point controller, three-point controller, boiler loading, P, PZ, PI, PID, P-PI, P-PID controllers, incoming air mixers, controller sequences, mixer sequences
- ▶ Setpoint: Heat curve, heating demand, setpoint device, setpoint ramp, setpoint adjustment
- ▶ Test: Simulation of values and states
- ▶ Clocks: Daily program, weekly program, annual program, clock with multiple switching periods in one FBox, national holidays, monthly switch-offs or switching periods one after the other on the same day, as well as FBoxes for reading and writing clock data

1.1.3 Increasing engineering efficiency through installation templates

1.1.3.1 DDC Suite

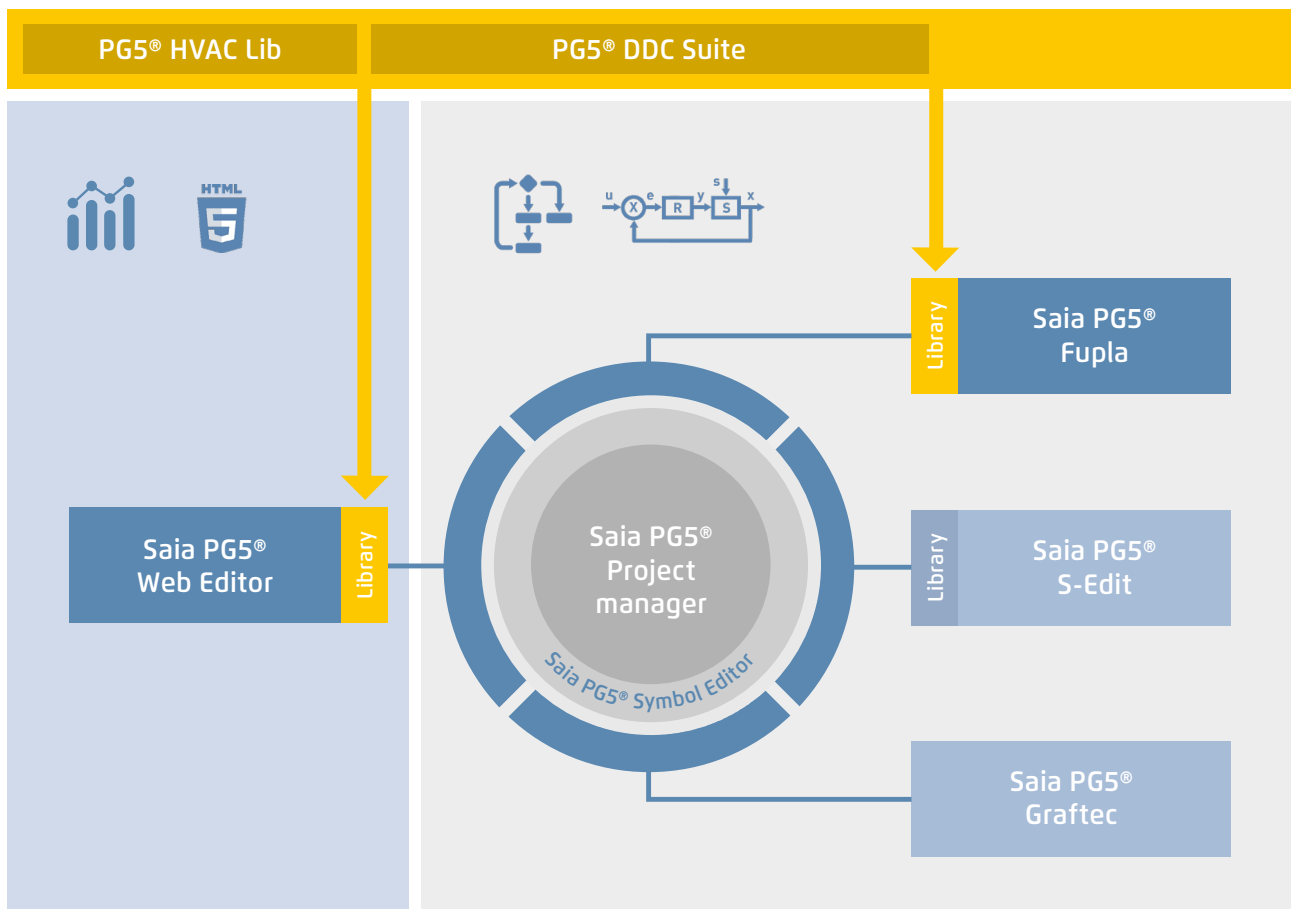

Saia PG5® Core + DDC Suite library

Using the Saia PG5® DDC Suite library and templates makes the creation of HVAC applications even simpler. Complex program structures and application elements such as complete pump controllers, incl. hour meters or entire control tasks for ventilation systems are grouped together as templates in individual function boxes and optimally add to the current HVAC library. This means that projects can be implemented efficiently.

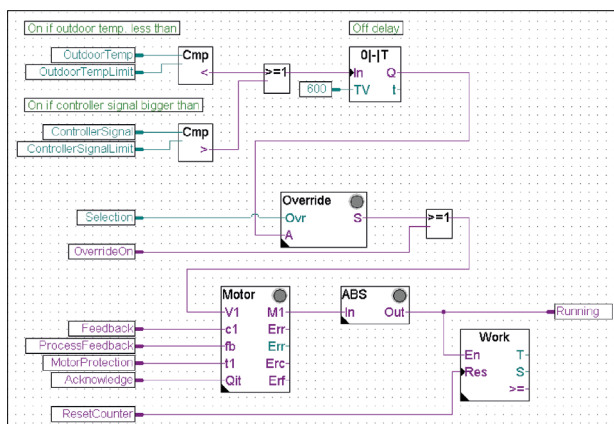

Total pump control with HVAC library

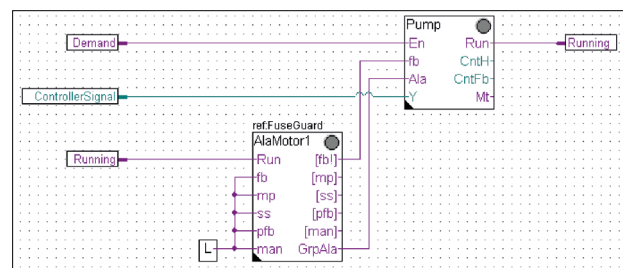

Total pump control with DDC Suite library

We can already see a number of benefits when comparing the two Fupla pages (HVAC and DDC Suite).

- ▶ It is easier to read and understand the Fupla program – fewer FBoxes and links on one page.
- ▶ Clear and transparent layout – easier to handle, e.g. for new colleagues in the developer or service team
- ▶ Easy to maintain

The following FBox families are available to the DDC Suite library user:

- ▶ DDC general: general FBoxes such as manual information, media access
- ▶ DDC analog values: FBoxes for capturing measurement values
- ▶ DDC BACnet: Scheduler, Trendlog, Loop, Notification Class
- ▶ DDC Releases: clocks, systems and aggregate switches
- ▶ DDC Initialisation: modules which must be inserted once into a Fupla and which provide basic functions.
- ▶ DDC controllers: control modules for components such as coolers, heat recovery systems and heaters
- ▶ DDC setpoints: conversions, setpoints
- ▶ DDC Controls: Triggering of motors, pumps, covers and drives
- ▶ DDC Fault: Fault modules for motors, fire protection and various components

This FBox library with highly integrated FBoxes uses individual data points and creates groups and symbols automatically.

The unique features of the DDC Suite are listed in 5 points:

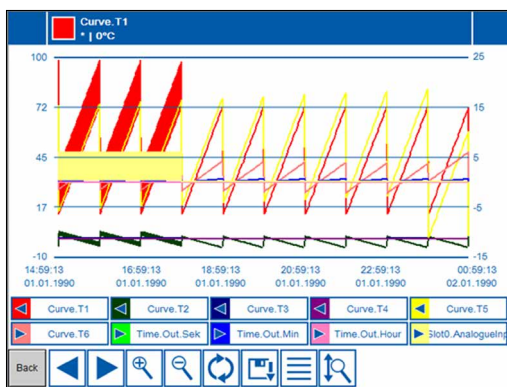

Trending

1. Integrated trending (offline history)

If data has to be recorded along with the actual control and regulation of a system, this is easily implemented with Saia PG5® DDC Suite. Data acquisition for trending can be initiated by defining the memory size in the object parameter window. When the automation system is in operation, data will be constantly saved in the Saia PCD® and available for evaluation. In addition, documentation (.txt) will be created in the Saia PG5® Project Manager of all the measured historical data. A list of the trend settings can be seen in this file. There is one entry for each trend with all the details.

ID	TID	Alarmtext	Time On	Time Off	ACK
56	17	A.Alarm.ThisAlarmList.MyName_17	01.01.1990 16:55:01	-	NAK
55	8	A.Alarm.ThisAlarmList.MyName_8	01.01.1990 16:55:01	-	NAK
54	16	A.Alarm.ThisAlarmList.MyName_16	01.01.1990 16:54:00	01.01.1990 16:55:00	NAK
53	7	A.Alarm.ThisAlarmList.MyName_7	01.01.1990 16:54:00	01.01.1990 16:55:00	NAK
52	15	A.Alarm.ThisAlarmList.MyName_15	01.01.1990 16:53:00	01.01.1990 16:54:00	NAK
51	6	A.Alarm.ThisAlarmList.MyName_6	01.01.1990 16:53:00	01.01.1990 16:54:00	NAK
50	14	A.Alarm.ThisAlarmList.MyName_14	01.01.1990 16:52:00	01.01.1990 16:53:00	NAK
49	5	A.Alarm.ThisAlarmList.MyName_5	01.01.1990 16:52:00	01.01.1990 16:53:00	NAK
48	13	A.Alarm.ThisAlarmList.MyName_13	01.01.1990 16:51:00	01.01.1990 16:52:00	NAK
47	4	A.Alarm.ThisAlarmList.MyName_4	01.01.1990 16:51:00	01.01.1990 16:52:00	NAK
46	12	A.Alarm.ThisAlarmList.MyName_12	01.01.1990 16:50:00	01.01.1990 16:51:00	NAK
45	3	A.Alarm.ThisAlarmList.MyName_33333	01.01.1990 16:50:00	01.01.1990 16:51:00	NAK
44	11	A.Alarm.ThisAlarmList.MyName_11	01.01.1990 16:49:00	01.01.1990 16:50:00	NAK
43	2	A.Alarm.ThisAlarmList.MyName_2_Mol	01.01.1990 16:49:00	01.01.1990 16:50:00	NAK
42	10	A.Alarm.ThisAlarmList.MyName_10	01.01.1990 16:48:00	01.01.1990 16:49:00	NAK
41	1	A.Alarm.ThisAlarmList.MyName_1_Te	01.01.1990 16:48:00	01.01.1990 16:49:00	NAK

Page 15
Total Alarms 250

Alarming

2. The principle of the trend function also applies to alarm functions.

By defining the alarm number in the object parameter window, the alarms are listed in a CSV file with numbers and text.

With Version 2.5 of the DDC Suite, the system identification key can be created completely freely directly from Fupla. The aim is to create the system identification key for the S-Web alarm texts and BACnet® completely freely according to the specifications from the Fupla program.

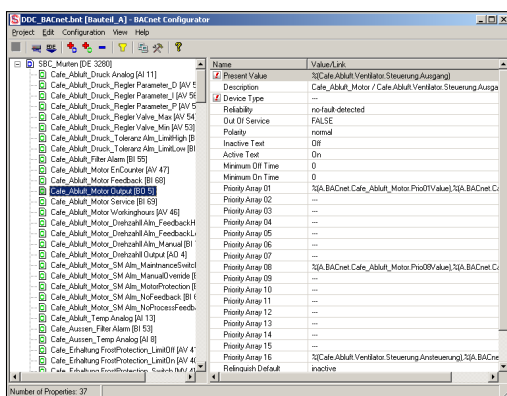

BACnet configurator

3. Automatic generation of BACnet® configurations

For BACnet® projects, the BACnet® object list is created automatically, which saves a great deal of error-prone manual work. The automatic generation of the BACnet® objects is the main reason why so many customers use the DDC Suite. In building automation, it is normal for all systems to map relevant hardware and software data points to BACnet® objects. This may mean that multiple data points are used in a BACnet® object. Thus, for example, a binary output could receive exactly the same return message and be monitored via intrinsic alarming. The control templates for the DDC Suite already contain all BACnet® definitions which can be activated by clicking. Thus BACnet® originates at the click of a button.

HTML document

4. The engineering documentation can be created quickly at the click of a button.

The documentation on all DDC Suite FBoxes is created as an HTML file.

This file contains a general description with all parameters and settings.

The documentation can be saved in the PCD and, for example, be used for viewing via the web. It is, however, also possible to post-edit the documentation using a text processing tool and to add images from the SCADA/web application.

5. Templates for Fupla, Web Editor and Saia PCD® Supervisor

The Saia PG5® DDC Suite largely comprises a highly integrated FBox library which is supplemented by a growing number of ready-made, tested and ready-to-use Fupla pages which fully map the typical parts of the system in terms of function. The Saia PG5® DDC Suite also provides the control and visualisation function for each FBox. Operation and visualisation using the web browser or Saia PCD Supervisor is already integrated and ready for use.

Fupla templates

In order to reduce the system programming time, entire applications (heating circuit, water heating, ventilation systems, etc.), including the calendar and control tasks, are fully integrated for free selection. Some suggestions for control settings and for system control can thus be freely added, changed or integrated.

Web Editor templates

The DDC Suite is also includes template objects for Web Editor. Graphic and control objects are available for every FBox. There are also templates for predefined systems.

Saia PCD® Supervisor templates

When importing data from Fupla into the Saia PCD Supervisor, the FBoxes are recognized with the help of the integrated mapping table and structured by the Saia PCD Supervisor according to the specifications of the FBoxes. Not only are the information points imported - units, min-max values, alarms and historical trends are also created automatically during import. In addition, the Saia PCD Supervisor user is provided with suitable template objects analogous to the Web Editor templates.

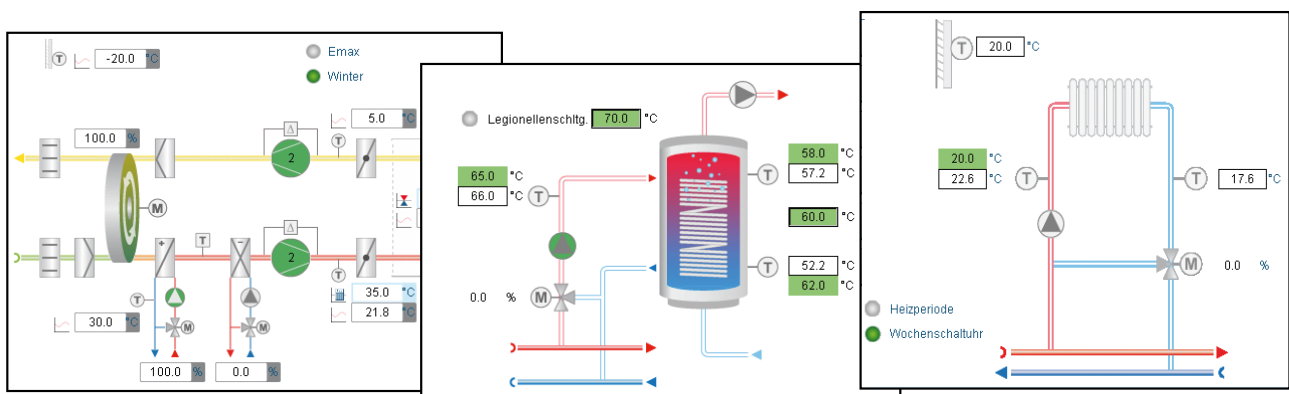

System display

1.1.4 Saia PG5® Controls Suite

1.1.4.1 My Controls Suite

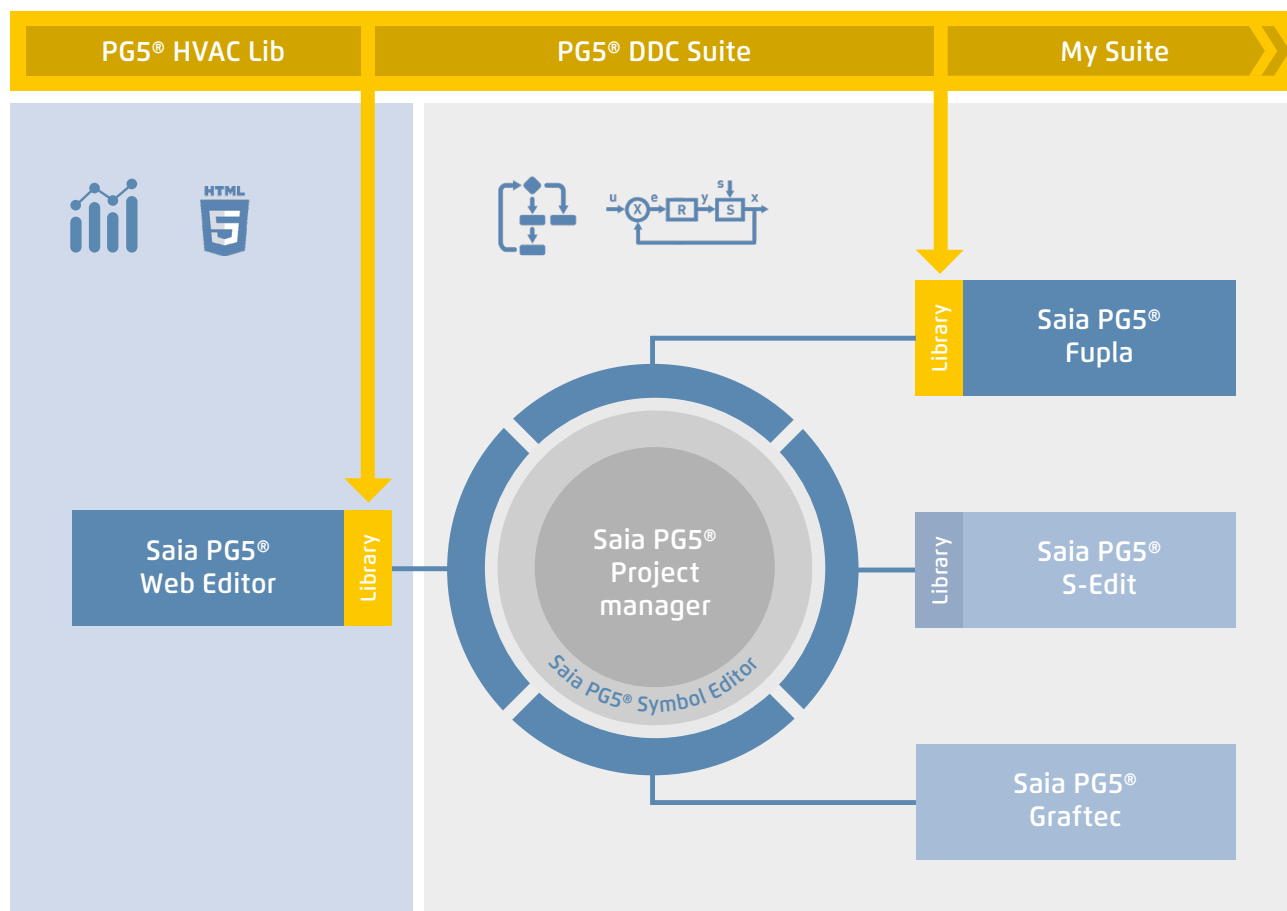

The use of predefined FBoxes and/or templates is not mandatory. Saia PG5® Core enables users to create individual templates and even define the templates with purely graphic engineering, with no IL programming required.

Create templates

Using templates significantly simplifies processes and reduces engineering time. To implement projects more efficiently, users can not only implement existing templates, but also incorporate user-specific engineering projects as templates. Users who have built their standard Fupla pages can export and save them as .fxp files (a .fxp file includes any number of Fupla pages). To reuse the pages, the .fxp files must be located and then imported.

In addition to the templates which can be easily created and reused, you can also create your own FBoxes and/or FBox library (My FBox Lib). The FBox Builder, contained in the Saia PG5® Core, is used for this.

Create FBoxes

The process of exporting Fupla pages and then reimporting them is simplified by the Saia PG5® FBox Builder. Users can import their .fxp files into the FBox Builder and then archive them as FBoxes.

This function (importing Fupla export pages/files) enables a structured group of FBoxes to be assembled into one large macro FBox. The Saia PG5® FBox Builder can then be used to document, maintain and export the new macro FBox as a new "product".

This capability allows users to build customised libraries for any other application. The FBox Builder enables users to develop their own FBoxes without writing a single line of instruction list code.

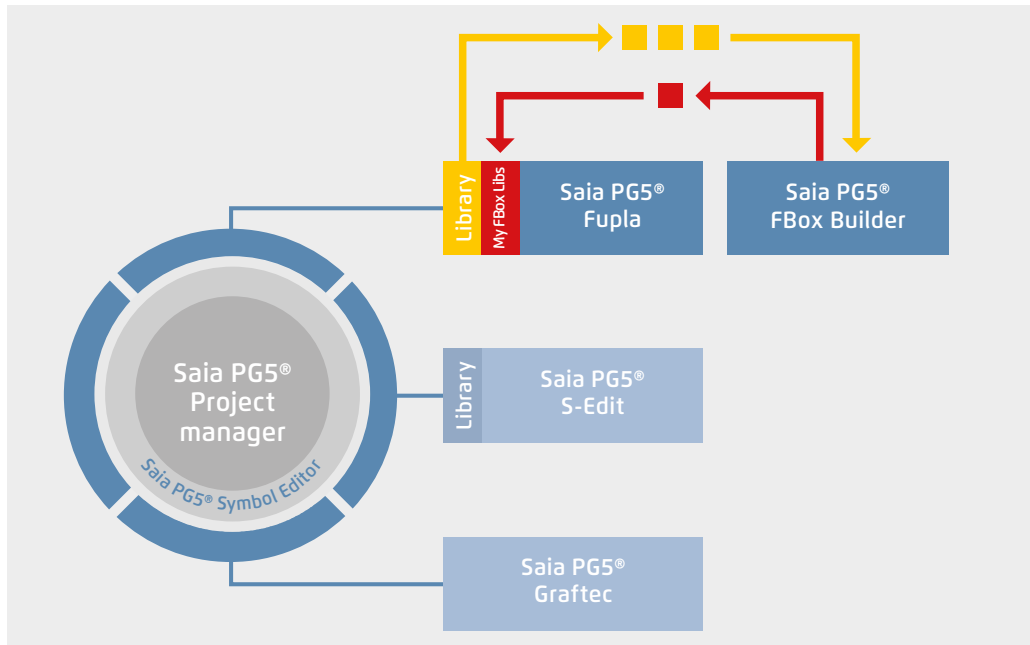

The Saia PG5® FBox Builder has additional functions that enable programmers to develop totally new FBoxes and to maintain them in their own library. The FBox Builder advanced version is required if the user wishes to integrate existing IL functions, modify existing FBoxes or even create totally new FBoxes. In addition to importing export pages (1), this version enables extensive functions such as:

- ▶ Importing existing FBoxes (2)
- ▶ Creating FBoxes "from scratch" (3)
- ▶ Importing IL code (4)

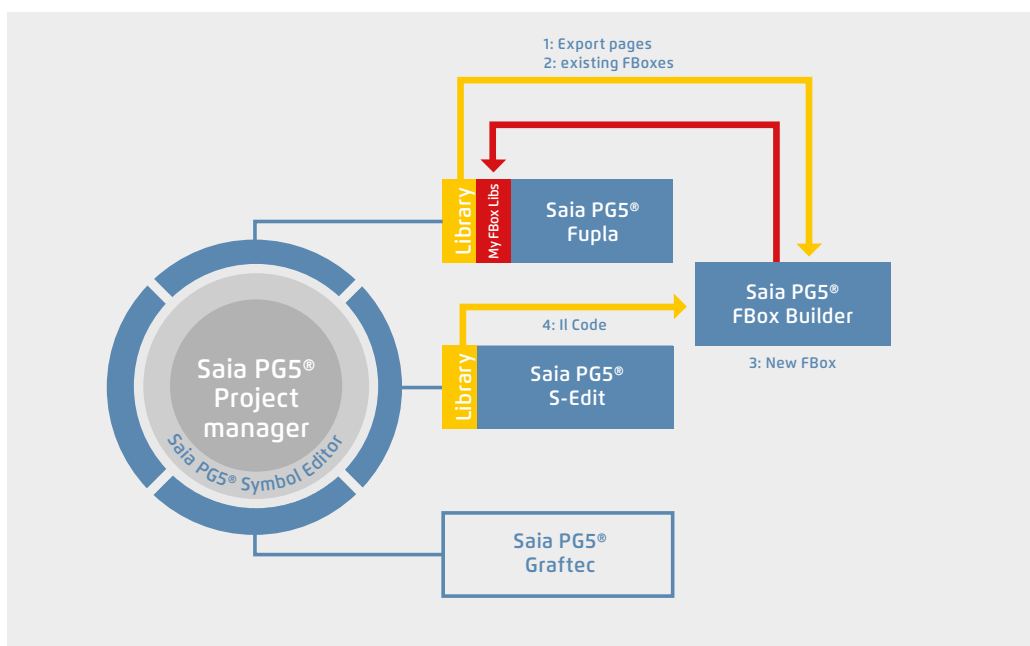

The advanced FBox Builder is suitable for experienced Saia PG5® IL programmers who have attended a workshop and own a licence for the FBox Builder Advanced add-on tools.



1.1.4.2 Overview of the tools and licence packages

The combined platform of the SBC software is the Saia PG5[®] Controls Suite DVD. It contains software tools for project management, engineering, programming and service. The DVD also includes application components with which you can increase your productivity when using Saia PCD[®] products. There is also a wide range of system software on the Saia PG5[®] Controls Suite DVD. This software is predominantly driver software to ensure easy and secure integration into a system environment.

Saia PG5[®] Controls Suite contains everything you need for automation

		
<p>PC tools</p> <p>Saia PG5[®] Core Project Manager</p> <ul style="list-style-type: none"> ▶ Application Programming ▶ Application Engineering ▶ Network Management ▶ Service <p>Saia PG5[®] Web Editor Tool for creating web pages for the Saia PCD[®] Web Server</p> <p>Saia PG5[®] HMI Editor Tool for Saia PCD[®] Text Panels</p> <p>Saia PG5[®] FBox Builder Tool for creating and managing Saia PG5[®] Fupla FBoxes</p> <p>Saia PG5[®] Online-Tools Downloading PG5 programs without installing the Saia PG5[®] Core</p>	<p>Application components</p> <p>Standard FBoxes Program modules for Saia PG5[®] Fupla, the graphic engineering tool</p> <ul style="list-style-type: none"> ▶ Arithmetic and logical FBoxes ▶ Analog FBoxes ▶ Communication FBoxes <p>Application FBoxes Program modules for Saia PG5[®] Fupla, the graphic engineering tool. FBoxes Alarm, DALI, DDC Suite, EIB, Energy Meter, EnOcean, Historical Data Capture, HVAC, Blinds/Lighting, JCI N2-Bus, e-mail Communication, Modbus, Modem, MP-Bus, Room Controller</p> <p>IL libraries Function blocks for counter modules, drive modules and analog modules can be integrated into IL programs</p>	<p>Application software</p> <p>SBC Web Connect The PC program enables access to the PCD WebServer via any communication interface (RS-232, RS-485, Profibus, Ethernet, etc.)</p> <p>Saia PG5[®] SD Flash Explorer With SD Flash Explorer, the content of the SBC file system can be extracted to the PC.</p>
<p>List of tools in the Saia PG5[®] Controls Suite</p>		

Licence packages

We have defined three packages as a global standard from the wide range of possible software combinations with the Saia PG5® Controls Suite. The training programs, online training and documentation are based on these.

Saia PG5® Core Package

With this package, all types of ICA tasks can be initiated on machines and systems. The graphic application components supplied support the use of the Saia PCD® Automation Server (Web + IT) and simple calculation and logic functions.

Saia PG5® HVAC Package

In addition to the Saia PG5® Core Package, additional graphic control module assemblies (FBoxes) are included which are oriented to the needs of HVAC primary systems. Template pages can be created from the basic collection of HVAC ICA modules which map any kind of system configuration.

Saia PG5® Extended Package

In addition to the Saia PG5® HVAC package, highly integrated graphic modules (DDC Suite) are included as well as a collection of templates which map the current system design of the HVAC technology.

→ For details see order information

Saia PG5® options – Add-on libraries: Tool is separated from libs. The FBox libraries can also be ordered.

Order information | Saia PG5® Controls Suite

Saia PG5® Programming Tool

PG5 – Demo version with all functions. Runtime limited to 90 days	PCD8.PG5-DEMO
Saia PG5® Core Package Programming software with editors (IL, Fupla, Graftec), network configurators, standard libraries (Analog, Communication, Arithmetic & Logic), application libraries (Alarming, Blinds-Lighting, e-mail, Trending [HDLLog], Energy Meter, DALI, Modbus, EIB, EnOcean, JCI N2-Bus), Web Editor and FBox Builder (basic version)	PCD8.PG5-CORE
Saia PG5® HVAC Package Similar to Saia PG5® Core Package and associated libraries (HVAC, Belimo MP-Bus, room controllers and modem), BACnet	PCD8.PG5-HVAC
Saia PG5® Extended Package Same as Saia PG5® HVAC Package and associated DDC Suite library	PCD8.PG5-EXTENDED
Saia PG5® Software Upgrade Upgrade according to customer's key Version 2.2 to 2.3	PCD8.PG5-UPGRADE
Saia PG5® Software Upgrade Upgrade from Core to HVAC package	PCD8.PG5-UPGR-HVAC
Saia PG5® Software Upgrade Upgrade from HVAC to Extended package	PCD8.PG5-UPGR-EXTD
End user licence for Saia PG5® End user licence for PG5. The customer is supported by the requisitioner (in accordance with the customer key)	PCD8.PG5-ENDUSER

Saia PG5® options – Add-on tools

PG5 – FBox Builder ("advanced version") Software package for Saia PG5® FBox Builder. IL knowledge needed and 1 day's training included	PCD8.PG5-FBOXBLD
--	------------------

1.2 Application software for Windows PCs

1.2.1 Saia PCD® Supervisor

1.2.1.1 Saia PCD® Supervisor

The complete solution for intelligently managing buildings and infrastructures

The scalable Saia PCD Supervisor software platform monitors and controls simple HVAC regulating systems as well as company-wide control stations in larger building complexes or infrastructure systems.

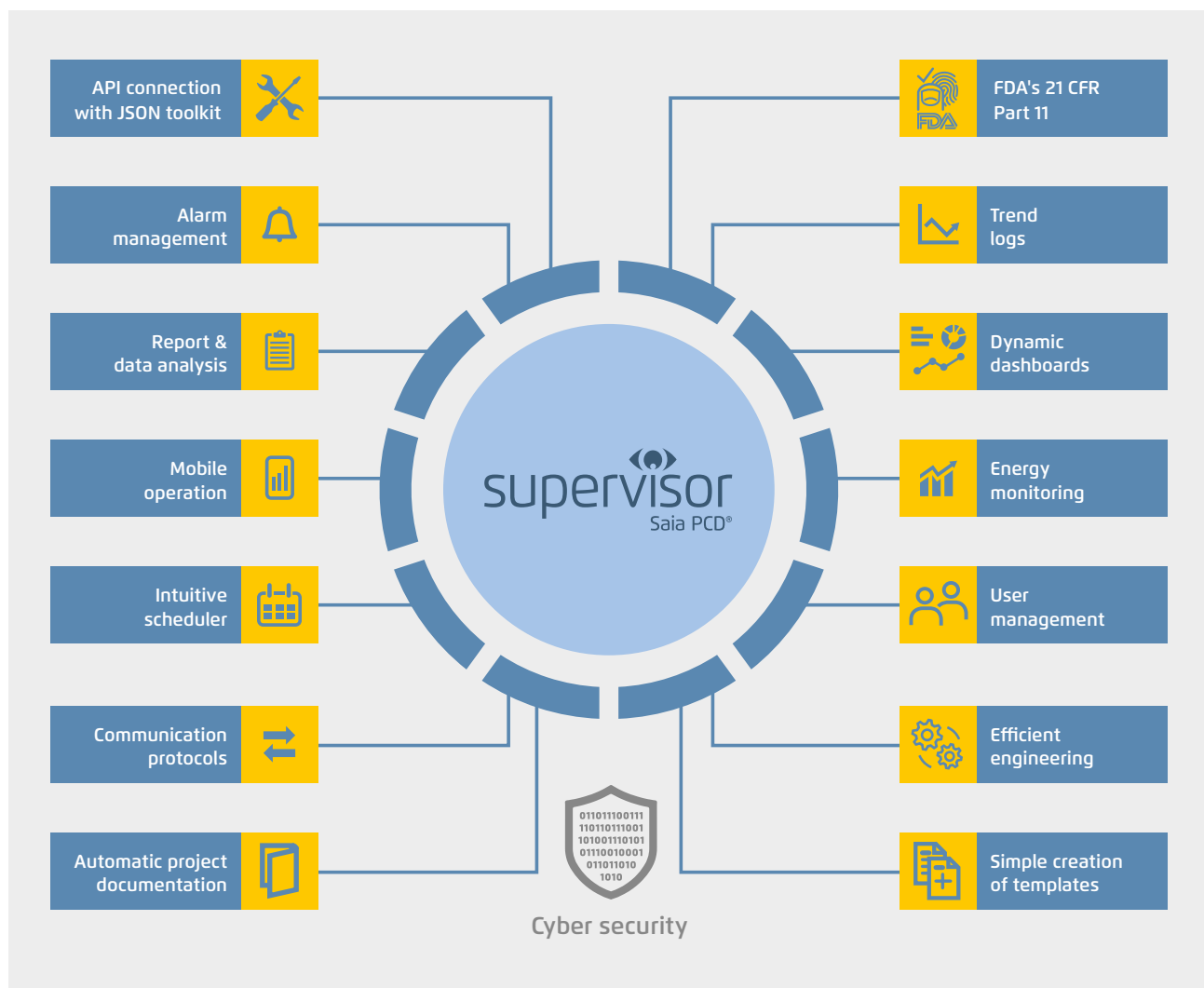

Main properties of the Saia PCD Supervisor

Complete solution: controlling, monitoring, reporting and visualising with just one centralised software platform

Compatibility: allows integration of all Saia PCD controllers, third-party devices and smart devices via IT protocols and numerous drivers

Flexibility: can easily be adapted to individual customer requirements

Technology standard: based on robust Tridium N4 technology with HTML5 and Cyber security

SBC: brand-specific additional services (S-Bus driver, Import Wizard and Icon Gallery) + ready-made S-Bus and BACnet DDC suite templates and intuitive HTML5 project visualisation templates

Complete solution

As a modern, scalable monitoring and management solution, the Saia PCD Supervisor bundles visualisation, interaction, monitoring and reporting in a user-friendly, high-performance software platform. Designed to offer compatibility regardless of brands, it allows the integration of all building systems across disciplines – even thirdparty systems. By bringing together all relevant data and displaying them in a way which is easy to understand, the Saia PCD Supervisor helps to optimise building systems and thus improve building efficiency significantly.

1. Visualisation

The Saia PCD Supervisor sets new standards: whether you use a desktop PC, a tablet or a smartphone – thanks to HTML5, real-time visualisations can be displayed without problems on virtually all devices. You can take advantage of the adjustable, predefined templates and responsive design.



2. System monitoring

The Saia PCD Supervisor conveniently presents system data in freely definable graphical system diagrams, as a trend diagram or in table form – all directly in a web browser, regardless of protocol, data point type, controller and operating system.

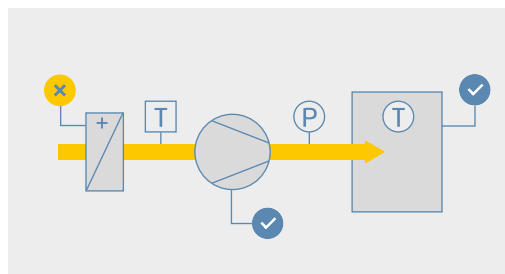

3. Reporting

Data can be exported as reports in CSV or PDF format at any time – this can also be done automatically. Thanks to the optional SQL and OPC interface, integration with other systems is easily possible.



4. Dashboards

Keep track of key performance indicators at all times: Users create and modify the dashboards themselves and save their own specific dashboards.

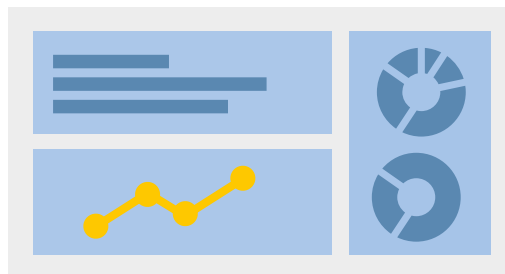

5. Monitoring

The Saia PCD Supervisor from SBC is a high-performance integration and monitoring platform with central data display for all building sub-systems. With Saia PCD Supervisor EM (see chapter 1.2.1.2), the energy monitoring software from SBC, the energy consumption of buildings is also analysed and monitored. As a result, it can be optimised.



Compatibility

Designed to offer compatibility regardless of brands, the Saia PCD Supervisor allows the integration of all building systems across disciplines. The platform monitors and controls all HVAC and non-HVAC systems such as lighting, shading or security systems. The Saia PCD Supervisor also supports all established communication protocols and integrates all systems and applications in a standardised structure, even across a number of buildings.

Large selection of drivers

Open communication, a factor which is relevant in today's building automation, is supported by various protocols including BACnet, LON, Modbus, M-Bus, KNX, OPC and SNMP. Most open systems are based on the TCP/IP communication standards and can be integrated directly into the Saia PCD Supervisor. Optionally, external systems can also be connected via SQL interface or a freely configurable API interface.



Faster, more efficient development

The open Niagara Framework on which the Saia PCD Supervisor is based allows developers to extend the framework and program their own unique applications, drivers, plug-ins, data displays and application logics for business applications. In addition to this, there is detailed documentation, a comprehensive, open API library and ready-made tools which provide support during development.

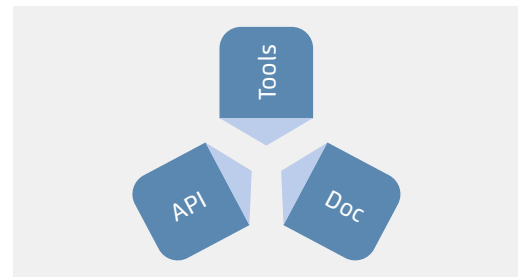

BACnet driver

The Saia PCD Supervisor is a BACnet-certified control centre which satisfies the BACnet profiles B-OWS (Operator Workstation) and B-AWS (Advanced Workstation). It is also certified in accordance with BTL "Revision 14". BACnet guarantees interoperability between devices from various manufacturers. A BIBB (BACnet Interoperability Building Block) defines which services and procedures need to be supported on the server and client side in order to achieve a specific system requirement. The PICS (Protocol Implementation Conformance Statement) document belonging to a device lists all supported BIBBs, object types, character sets and communication options. With the Saia PCD Supervisor, it is possible to scan for BACnet objects within the network or import them via EDE files.



High level of flexibility

The system can be extended almost unrestrictedly and adapted to meet the individual requirements of integrators, planners or operators.

Modular and scalable

Individual buildings can be managed in the same way as larger building complexes and facilities spread across various sites. All important SCADA functions are already included in the basic packages. Thanks to data point extensions – even for open protocols – the system can be adapted to the particular project size at any time. The customer can therefore select any package as a basis and add various data points at any time in order to give the Supervisor system the capacity it needs for the points to be monitored and controlled. All Saia PCD Supervisor basic packages also include an 18-month maintenance package and with this warranty, a free upgrade of older versions. Continuous maintenance is necessary in order to keep the system up to date. This can be extended by purchasing maintenance upgrade options. Our partners also get an engineering licence (annual contract) which can be used to configure, test and demonstrate the Saia PCD Supervisor. With this annual contract, partners also receive support from SBC (training and technical assistance) in order to ensure that the Saia PCD Supervisor can be operated properly.

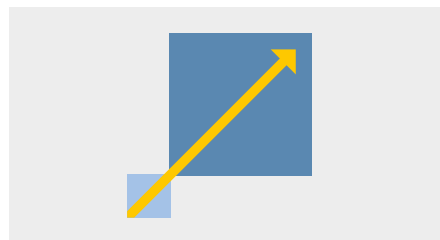

Normalised data points

The data of connected devices and networks are normalised in the Saia PCD Supervisor and are then available throughout the system. Normalised means that the data read by the driver are packaged in a standardised data structure and can be used in the same way in any function and visualisation. Each data point in the Saia PCD Supervisor can provide a priority array. S-Bus, M-Bus or BACnet data points are also supplemented with a priority array in the Saia PCD Supervisor. The priority array makes it possible to execute various operating states on the same data point with a different priority.

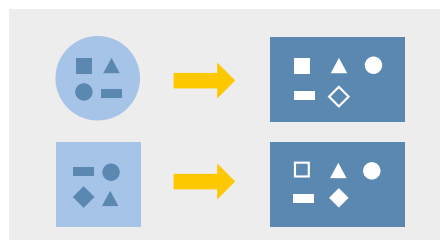

Higher-level functions

The Saia PCD Supervisor provides a level for higher-level functions with the Wire Sheet (similar to the PG5 Fupla).

- ▶ Creating cross-building data sets
- ▶ Preparing data for reports and visualisation
- ▶ Creating alarm escalations and e-mail recipients

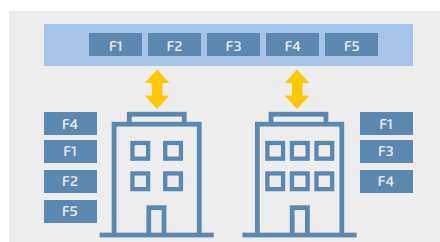

Tailored visualisation

Each user logged in to the system focuses on various individual tasks. The information in a system is therefore user-specific. With the Saia PCD Supervisor, each user sees exactly what is relevant to them: system technicians see the system diagrams and MSR technicians see additional control parameters. The facility manager can also change time plans while the security personnel receive security-related messages. Naturally, all of this can be set up in accordance with specific user requirements. The status reports too can be personalised. The Saia PCD Supervisor offers sophisticated functions for filtering, processing, escalating and forwarding alarms. It is also possible to send alarms via e-mail.

Technological standard

The Saia PCD Supervisor is based on the proven Niagara 4 Framework which is already used in over half a million applications around the world.

Cyber security

The Saia PCD Supervisor is secure as standard and uses the "Defence in Depth" approach for the security architecture on the Internet of Things which is based on the security concept of the Niagara Framework. For authentication, users must select secure login information. In addition, both transmission data and data on network drives must be encrypted. The Saia PCD Supervisor also uses role-based access authorisations. As a result, user authorisations can be configured easily and are less susceptible to errors. The user concept is based on categories, roles and users. This setup allows a very detailed description of the rights of a user within a system up to individual data point features. Each user is assigned a role which defines their access rights and locations. If a user is given a new role in the system, the rights needed for this are added immediately. Each user can also be assigned an individual start page and an individual language. The Saia PCD Supervisor can also be integrated into existing systems for identification and access management such as LDAP or Kerberos. All user activities and security-relevant events are recorded in the Niagara Audit Log and can be traced.



HTML 5

The Saia PCD Supervisor features an intuitive user interface for comprehensive building management. It uses the HTML5 standard in order to provide numerous reliable functions and thus combines maximum control with the very highest data security.



System requirements

- ▶ The Saia PCD Supervisor supports the following operating systems:
 - ▶ Windows 10 (64 bit)
 - ▶ Windows Server 2016
 - ▶ Windows Server 2019 (64 bit)
- ▶ In addition to the operating system requirements for the Saia PCD Supervisor, the following requirements must also be met:
 - ▶ Processor: Intel® Xeon® CPU E5-2640 x64 (or more powerful), compatible with dual and quad core processors
 - ▶ Memory: at least 6 GB; for larger systems, 8 GB or more recommended
 - ▶ Free hard disk space: at least 4 GB; 10 GB recommended for any supervisor; more may be required depending on the archiving requirements
 - ▶ Display: Video card and monitor capable of displaying 1024 × 768 pixel resolution, minimum of 1920 × 1080 recommended
 - ▶ Supported networks: Ethernet adapter (10/100 MB with RJ-45 connection)
 - ▶ Connectivity: permanent ISP high-speed connection for remote site access recommended (e.g. T1, ADSL, cable modem)
- ▶ If data archiving is necessary on a company level (optional), one of the following compatible database applications must be installed:
 - MS SQL Server 2012, 2016, 2017 and 2019,
 - MySQL Server 5.7 and MySQL Server 8.0
 - Oracle Express 11g, Oracle 12c, 18c, 19c.

SBC-specific benefits

Efficient engineering

A wizard simplifies migration (Ether-S-Bus, S-Bus-Gateway) of all PCD controllers incl. backwards compatibility. An adjustable mapping table defines features and enhancements to data points. Users' own templates can be created independently of protocol and individually visualised via library for S-Bus and BACnet (compatible with PG5 templates). Users can generate their own HTML5 structure for web visualisation with a project template. The Database Manager extension allows an overview of the existing / used licence data points at any time. In addition, it allows you to automatically delete all unused data points from the project. With the additional JSON toolkit, it is possible to integrate any application / device via freely definable API interfaces.

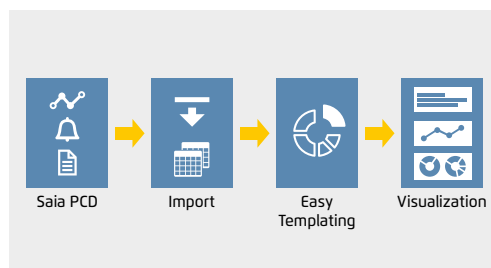

Saia PG5® Import Wizard

The Import Wizard extends the Saia PCD Supervisor with an efficient and fault-free data import of the existing PG5 data point structure with the help of a pre-defined and adjustable mapping table. This can be modified for every FBox and enhanced with the features of all Saia PCD Supervisor components. For instance, in the DDC-Suite 2.7 FBoxes, all features and enhancements are therefore added to the data points directly during the import. Via the Saia PG5® Import Wizard, symbols and alarm lists with alarm texts from a Web Editor 8 project as well as HDLog lists previously defined in PG5 projects can be imported into the Saia PCD Supervisor quickly and easily. The filter functions can be used if only selected symbols are to be imported. During the import process, the Ether-S-Bus driver is created and configured. All CPUs in a PG5 project where data points were selected are automatically created under the driver as a device and configured for communication. From this moment, data point communication begins automatically when the PCD is available in the network and the device configuration is correct.

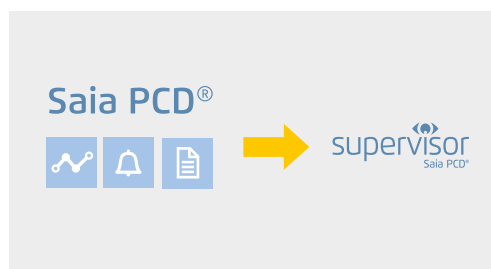

SBC Icon Gallery

The Saia PCD Supervisor supports all common image formats such as PNG, SVG, GIF and JPG. In addition to 3D graphics, the graphics in the SBC Icon Gallery on the basis of SVG files are available as usual. Graphics and system diagrams are created in the Saia PCD Supervisor graphics editor. Systems are often made up of the same system parts. These can be created in the Saia PCD Supervisor on a one-off basis and reused. In order to reuse a created object, it is dragged to a page using drag and drop. In the process, data points are automatically connected with the correct system. Changes to an object are made immediately to all usage instances. This is possible both with individual objects and with complete views.

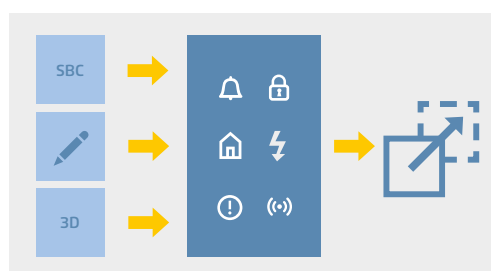

S-Bus driver

Complete solution for integrating a Saia PCD controller via the proprietary S-Bus: the SBC S-Bus-over-IP driver is ideal for connection to PCD1, PCD2, PCD3, PCD7 and gateways.

Supported functions:

- ▶ Reading and writing all Saia PCD media
- ▶ Reading the Saia PCD status and the firmware version
- ▶ Reading out the HDLog data
- ▶ Receiving and acknowledging alarms from the PCD system

It is possible to use a number of PCD controllers under an SBC IP network driver. A number of SBC IP network drivers can also be managed in one system. The systems can thus be separated or optimised.

It is also possible to place PCD sub-stations under PCD devices which cannot be connected directly via an Ethernet interface (S-Bus gateway).



Training and technical assistance

A four-day engineering training course provides all the knowledge needed for successful project work.

On the basis of an extensive demo project, participants are taught how to work with the Saia PCD Supervisor in a practical context. And if questions or problems arise later on, our technical support department would be happy to help!

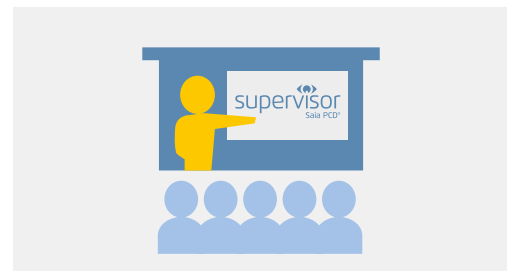

Supported PCD devices

Saia PCD devices are connected directly to the Saia PCD Supervisor via an Ethernet interface.

Devices with an RS-485 interface can communicate with the management system via a gateway station which is connected to the Saia PCD Supervisor via Ethernet.

The following devices are supported:

- | | | |
|---|--|---|
| <ul style="list-style-type: none"> ▶ PCD with RS-485 interface for connection to a gateway station which is connected to Saia PCD Supervisor via Ethernet: <li style="padding-left: 20px;">PCD1.G/F/Wxxx-xx5 with RS-485 (as slave of a gateway station). | <ul style="list-style-type: none"> ▶ PCD1.M0160E0 ▶ PCD1.M2xx0 ▶ PCD2.M4x60 | <ul style="list-style-type: none"> ▶ PCD2.M5xx0 ▶ PCD3.Mxxx0 ▶ PCD7.D4xxxT5x |
|---|--|---|

Products and licences

The licensing scheme for the Saia PCD Supervisor is geared to the number of points. A point is an individual information element which is stored in the Saia PCD Supervisor database. With Saia PCD controllers, these are flags, registers, inputs, outputs etc. which can be read or written by the Saia PCD Supervisor via S-Bus. There are also open points, e.g. BACnet IP, EIB/KNX IP, LON IP, Modbus IP, M-Bus IP, OPC and SNMP.

S-Bus points

These are points controlled by SBC manufactured controllers (PCD1, PCD2, PCD3 and PCD7) and accessed using the S-Bus Protocol. For this category of device the license is sized on the points you want to monitor. Point discovery is an embedded feature available through the Saia PG5® Import Wizard embedded in the S-Bus driver. SBC devices and networks are not counted for licensing purposes.

S-Bus extensions

In case more points are needed to meet system requirements, the desired Saia PCD® Supervisor database size can be reached with any combination of Starter Kit and Point Extensions.

Open points

These are points from open protocol equipped devices or subsystems that you wish to integrate straight into Saia PCD® Supervisor. The Saia PCD® Supervisor open driver packs include a selection of standard drivers that you can select to be used to perform head end integration. Standard drivers are: BACnet IP, EIB/KNX IP, LON IP, Modbus IP master and slave, M-Bus IP, SNMP and OPC client.

Please note that open protocol license management is delivered in a way that as soon as you reach the limit for point count customers need to request license upgrade accordingly.

Maintenance upgrade options

Saia PCD® Supervisor basic packages include an 18 months maintenance and free upgrade package. This can be extended by purchasing maintenance upgrade options.

Extended connectivity options

Upgrade connectivity for communication from Saia PCD® Supervisor to another.

Extended support options

These options extend the Supervisor's ability to communicate with Excel, My SQL Server, SQL Server, Oracle Server, JSON Toolkit for Supervisor (Valid SMA Required) and Micros Fidelio IP Driver.

Video integration options

Device drivers for various camera types for up to 128 connected cameras.

Energy Management options

Comprehensive solution for energy monitoring in the Saia PCD® Supervisor. Monitor and optimize the energy consumption of your entire building.

Security options

Provides interface to integrate the Niagara Enterprise Security Supervisor database to active Directory/LDAP.

Cloud connection options

Allows Supervisor to access the Niagara Cloud Honeywell Sentience Driver.

Partner license agreements

Partner license agreements can be signed and renewed annually, for single or multiple engineers. Maximum flexibility is provided by the license for one month limited to one engineer (workstation).

Licence model and order codes for end users

Basic S-Bus packages

PCD8.SUP-500
PCD8.SUP-2500
PCD8.SUP-10000
PCD8.SUP-25000
PCD8.SUP-50000
PCD8.SUP-100000

Saia PCD® Supervisor basic package including SBC S-Bus driver and 500 points database size
Saia PCD® Supervisor basic package including SBC S-Bus driver and 2,500 points database size
Saia PCD® Supervisor basic package including SBC S-Bus driver and 10,000 points database size
Saia PCD® Supervisor basic package including SBC S-Bus driver and 25,000 points database size
Saia PCD® Supervisor basic package including SBC S-Bus driver and 50,000 points database size
Saia PCD® Supervisor basic package including SBC S-Bus driver and 100,000 points database size.

S-Bus extensions

PCD8.SUP-100EXT
PCD8.SUP-2500EXT
PCD8.SUP-5000EXT
PCD8.SUP-15000EXT
PCD8.SUP-50000EXT

Saia PCD® Supervisor additional 100 SBC database points
Saia PCD® Supervisor additional 2,500 SBC database points
Saia PCD® Supervisor additional 5,000 SBC database points
Saia PCD® Supervisor additional 15,000 SBC database points
Saia PCD® Supervisor additional 50,000 SBC database points.

Extensions with open protocols

PCD8.SUP-500OPEN
PCD8.SUP-2500OPEN
PCD8.SUP-5000OPEN
PCD8.SUP-10000OPEN
PCD8.SUP-25000OPEN
PCD8.SUP-50000OPEN

Extend base license with additional 500 open protocols points
Extend base license with additional 2,500 open protocols points
Extend base license with additional 5,000 open protocols points
Extend base license with additional 10,000 open protocols points
Extend base license with additional 25,000 open protocols points
Extend base license with additional 50,000 open protocols points.

Maintenance upgrade options

PCD8.SUP-MNT1
PCD8.SUP-MNT3
PCD8.SUP-MNT5

Saia PCD® Supervisor maintenance upgrade - additional 1 year
Saia PCD® Supervisor maintenance upgrade - additional 3 years
Saia PCD® Supervisor maintenance upgrade - additional 5 years.

Extended connectivity options

PCD8.SUP-1N-UP
PCD8.SUP-10N-UP

Upgrade connectivity for communication from Supervisor to another one by 1
Upgrade connectivity for communication from Supervisor to another one by 10.

Extended support options

PCD8.SUP-DB-CSV
PCD8.SUP-DB-MYSQL
PCD8.SUP-DB-ORCL
PCD8.SUP-DB-SQL
PCD8.SUP-JSON
PCD8.SUP-HTTP
PCD8.SUP-FID

Extend the capability for the supervisor to interact with Microsoft Excel
Extend the capability for the supervisor to communicate with MySQL Server
Extend the capability for the supervisor to communicate with Oracle Server
Extend the capability for the supervisor to communicate SQL server
Extend the capability for the supervisor to enable JSON Toolkit for Supervisor (Valid SMA Required)
HTTP service interaction as web services and RESTful API
Extend the capability for the supervisor to interact with Micros Fidelio IP Driver.

Video integration options

PCD8.SUP-MLS-16
PCD8.SUP-MLS-64
PCD8.SUP-MAXP-16
PCD8.SUP-MAXP-64
PCD8.SUP-MAXP-128
PCD8.SUP-AXIS-16
PCD8.SUP-AXIS-64

Milestone Driver to connect 16 Camera Devices
Milestone Driver to connect 64 Camera Devices
Maxpro Driver to connect 16 Camera Devices
Maxpro Driver to connect 64 Camera Devices
Maxpro Driver to connect 128 Camera Devices
Axis camera driver included HTML5 video streaming and alarming for 16 videos
Axis camera driver included HTML5 video streaming and alarming for 64 videos.

Energy Management options

PCD8.SUP-EM25
PCD8.SUP-EM50EXT
PCD8.SUP-EM100EXT
PCD8.SUP-EM500EXT
PCD8.SUP-EM1KEXT
PCD8.SUP-NA-250
PCD8.SUP-NA-1000
PCD8.SUP-NA-10000

Saia PCD® Supervisor EM base license for Saia PCD Supervisor with max. 25 meter points
Saia PCD® Supervisor EM license for additional 50 meter points
Saia PCD® Supervisor EM license for additional 100 meter points
Saia PCD® Supervisor EM license for additional 500 meter points
Saia PCD® Supervisor EM license for additional 1000 meter points
Niagara Analytics Framework license for 250 analytic points
Niagara Analytics Framework license for 1000 analytic points
Niagara Analytics Framework license for 10000 analytic points.

Security options

PCD8.SUP-LDAP
PCD8.SUP-ESIG-1000
PCD8.SUP-ESIG-UNL
PCD8.SUP-ESIG-UP1K

Provides interface to integrate the Niagara Enterprise Security Supervisor database to active Directory/LDAP
E-Signature Application with 1'000 secured points
E-Signature Application with unlimited secured points
E-Signature Application upgrade to add 1'000 additional secured points.

Cloud connection options

PCD8.SUP-CLO-500
PCD8.SUP-CLO-2500
PCD8.SUP-CLO-10000

Niagara Cloud Honeywell Sentience Driver 500 points
Niagara Cloud Honeywell Sentience Driver 2500 points
Niagara Cloud Honeywell Sentience Driver 10000 points.

Partner license agreements

PCD8.SUP-NAA-MON
PCD8.SUP-NAA-STK1
PCD8.SUP-NAA-STK5
PCD8.SUP-NAA-REN
PCD8.SUP-NAA-ENG

Saia PCD® Supervisor Starter kit, monthly agreement for 1 engineer*
Saia PCD® Supervisor Starter kit, annual agreement for 1 engineer
Saia PCD® Supervisor Starter kit, annual agreement for 5 engineers
Saia PCD® Supervisor annual agreement renewal
Saia PCD® Supervisor one additional engineering license.

* PCD8.SUP-NAA-MON licenses can only be purchased by new partners. From purchase's month until renewal. You must always purchase as many monthly licenses as you need for the period until November 30th. After November 30th, they will be renewed for 1 year with the normal PCD8.SUP-NAA-REN.

1.2.1.2 Saia PCD® Supervisor EM

Comprehensive solution for energy monitoring in the Saia PCD Supervisor. Saia PCD Supervisor EM is a benchmarking and analysis tool for monitoring energy consumption – an integrated solution for all types of buildings. It allows a wide range of energy data to be recorded and optimised at a central location.

The BAFA-supported (German market) Saia PCD Supervisor EM is the ideal system for:

- ▶ Recording, analysing and optimizing energy consumption
- ▶ Measuring energy consumption across disciplines
- ▶ Setting up an energy monitoring system in accordance with DIN EN ISO 50001
- ▶ Automatic creation of tenant billing



The complete solution for energy monitoring is fully integrated into the Saia PCD Supervisor. It includes an impressive array of technologies to manage all aspects of energy-related data.

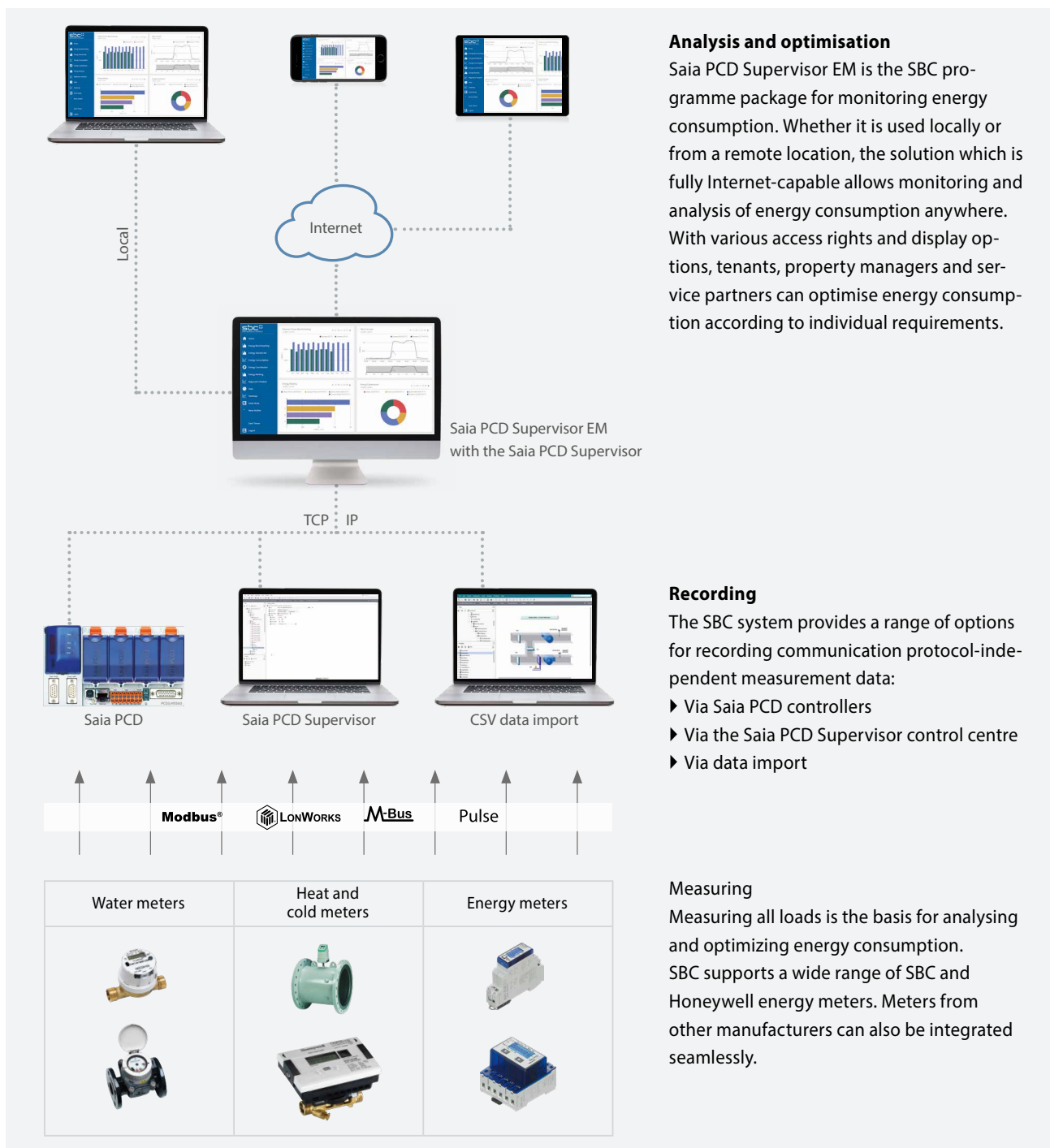

Saia PCD Supervisor EM converts technical data into easy-to-understand graphics, including diagrams with details of the costs in CHF, EUR, GBP or USD. Automatically generated PDF reports can also be sent via e-mail.

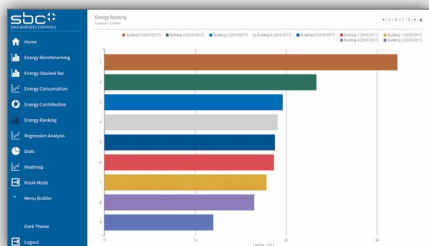

Energy ranking

Visualise and compare the performance of your sites, buildings and systems. Increase energy efficiency by optimizing your biggest loads.



Energy benchmarking

Compare consumption in various areas during similar periods and thus identify areas with low energy efficiency.

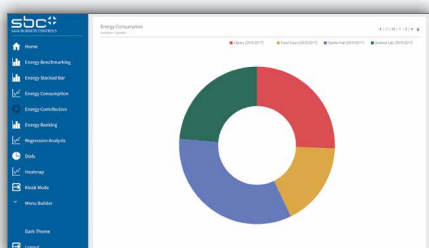

Energy consumption analyses

Gain an overview of energy consumption and the corresponding costs in various areas, buildings and periods.



Daily load profile

Identify inefficient energy use by comparing 24-hour periods on different days.



Heat map

Bring up a heat map view of annual data for a load. Would you like to see the profile for a specific day? Simply click on the relevant part of the overview. Configure the heat map according to your specific needs.

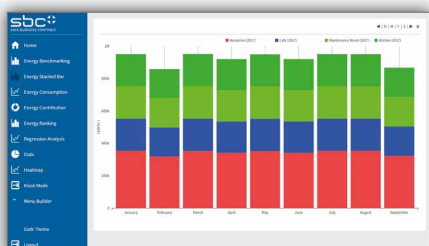

Stacked bars

Stacked bar diagrams show how individual loads contribute to total energy consumption over time – within a day, a week or a year – as well as the corresponding costs. On this basis, you can also define specific or general targets or budgets.

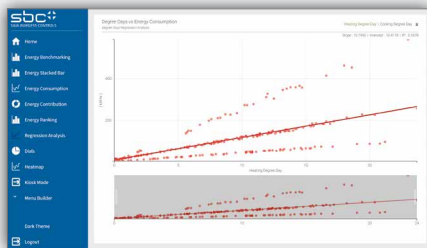

Regression analysis

Compare energy consumption with outside temperature, degree days or another value on the basis of regression lines.

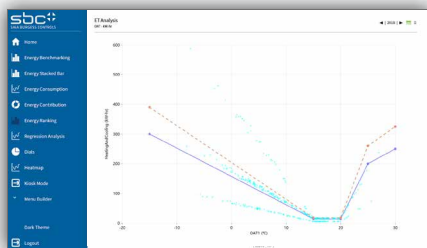

Energy Temperature Curve (ET Curve)

ET Analysis helps determine how the energy consumption of a site varies with temperature. For a given time period, the kWh/m² of a site and temperature can be superimposed onto a graph showing the ideal consumption for the period.

Data Quality

Users can now view the integrity of the data displayed within charts via a 'Data Quality' icon placed to the top right of most charts (not applicable to Regression and the HeatMap charts). The button's colour changes based on the minimum integrity value returned from the data set being displayed on the chart.

A simple colour code system [red, amber, green] is used to show the integrity of the data between 80-100% scale. An integrity level below 80% remains red.

Colour scale example:

100%	95%	80%

Order information

Saia PCD Supervisor EM offers the Core licence as standard. With this licence, 3 measured values are permanently available free of charge.

In addition, Core users can test the functions of the Pro licence for 60 minutes. During this trial period, data from aggregators is randomised.

Order codes

Type	Description
PCD8.SUP-EM25	Saia PCD® Supervisor EM: Basic licence for the Saia PCD Supervisor with a maximum of 25 measured values
PCD8.SUP-EM50EXT	Saia PCD® Supervisor EM: Licence for an additional 50 measured values
PCD8.SUP-EM100EXT	Saia PCD® Supervisor EM: Licence for an additional 100 measured values
PCD8.SUP-EM500EXT	Saia PCD® Supervisor EM: Licence for an additional 500 measured values
PCD8.SUP-EM1KEXT	Saia PCD® Supervisor EM: Licence for an additional 1,000 measured values

1.2.2 SBC OPC Server

Providers of various automation systems trigger the communication between the user and automation through dedicated manufacturer-specific protocols. Each device requires its own software installation on the operator's computers/end devices. If several different devices are to be accessed with one end device, this generally requires a very complex PC installation. With the following consequences: Complex systems, high costs for investment and maintenance as well as limited flexibility for changes/enhancements.

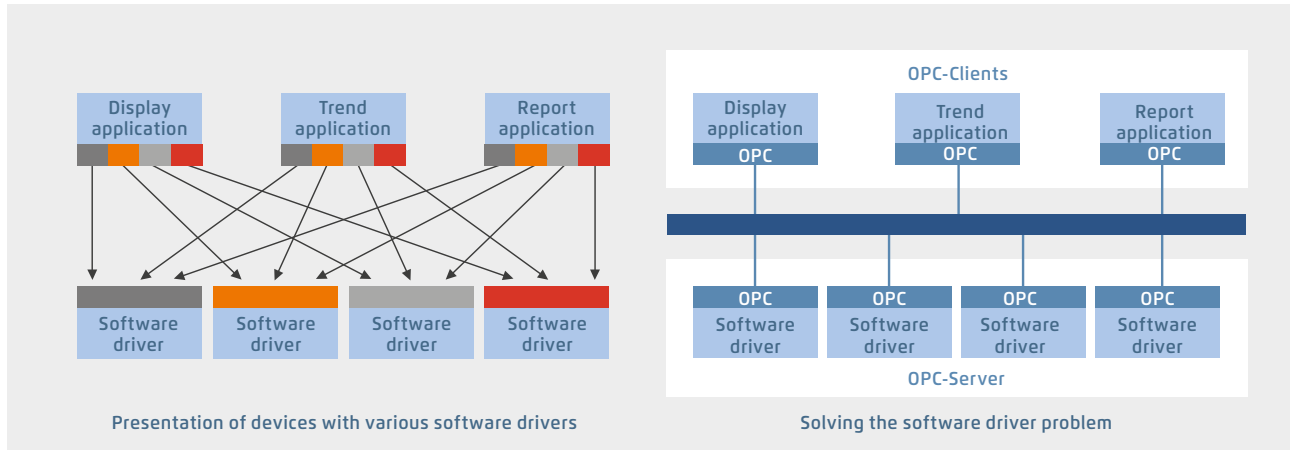

The standardised OPC interface eliminates the need for specialist knowledge of the manufacturer-specific protocols. This results in significantly lower costs and effort for development, commissioning and maintenance.

OPC servers in combination with the SBC S-Bus

- ▶ OPC project: All OPC data for networked controllers is brought together in a single project. This produces a clear data structure and simplifies the proper definition of data points
- ▶ Import of PLC variables: Symbols and data points previously defined for the PLC program with the Saia PG5® Controls Suite software tool can be carried over and used unmodified by the OPC Server. Data formats for import functions include: *.src (PG3, PG4), *.pcd (PG4, PG5), *.sy5 (PG5), *.csv (comma separated values; e.g. from Excel)
- ▶ OPC Server / Saia PCD®: Visualisation and management systems with OPC client interfaces can be connected to any Saia PCD® controller via the OPC Server. This enables every OPC client, via the OPC Server, to read data from the PCD or write data to the PCD. PLC data that can be displayed in OPC Server includes: Inputs, outputs, flags, registers, data blocks, texts, timers, counters, date-time, firmware version

Supported OPC data access standards

1.01a, 2.05a

Supported PC operating systems

Windows Server 2008, Windows Server 2012, Windows 7, Windows 8, Windows 8.1, Windows 10

Communication by all routes

Communication between the OPC Server and the Saia PCD® can take place via RS-232, RS-485, modem, TCP/IP, Profibus or USB. Several OPC clients can access the OPC Server simultaneously via multiple PC interfaces

Supported protocols

S-Bus Data, Parity and Break mode, S-Bus via UDP/IP (Ether-S-Bus), S-Bus via Profibus (Profi-S-Bus), PGU-Mode

Order information | Saia OPC Server for SBC S-Bus

SBC OPC Server – Full version, for one PC and one application	PCD8.OPC-1
SBC OPC Server – Full version, for 3 PCs with the same application	PCD8.OPC-3
SBC OPC Server – Full version, for 5 PCs with the same application	PCD8.OPC-5

1.2.3 BACnet Explorer

BACeye provides an overview in a BACnet network. BACeye can be connected to any BACnet network for easy analysis and switching and for testing events and alarms.

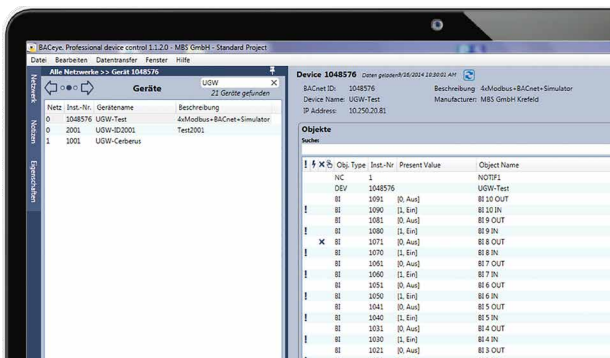

BACnet networks

With the BACnet Who-Is/I-Am services, devices in the network can be conveniently identified and an image of the device properties and objects can be read in BACeye. A detailed display of all objects allows access to the object properties.

EDE files

Generate EDE files quickly and easily. The EDE file (Engineering Data Exchange) is a format for a BACnet data point list specified by BACnet Interest Group Europe (BIG-EU).

Monitoring list

The monitoring list displays the most important properties of the selected objects. The objects can be compiled from the same or from different devices.

Alarms

All objects are displayed together with their status information (Status_Flags). Users can of course filter and search for status functions at any time.

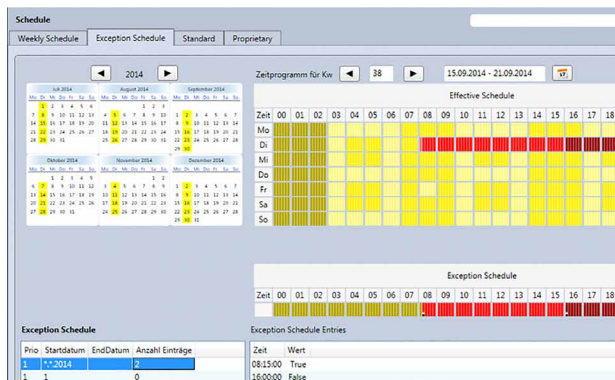
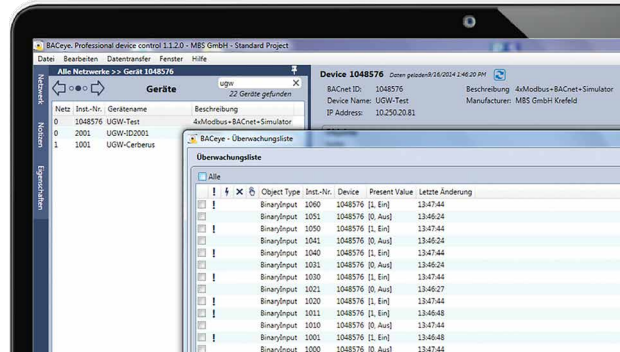

Schedules

BACnet calendar and schedule objects can be conveniently displayed and edited with BACeye.

The weekly program (Weekly Schedule) and the Exception Schedule can be edited separately. The combined display enables an overview of the actual effective value.

The Weekly Schedule and Exception Schedule can be edited separately. The combined display enables an overview of the actual effective schedules.

Ordering information

BACnet explorer software tool for professional analysis and diagnostics of building automation networks. License valid for 1 user

PCD8.BACnet-Eye-1

With Saia PCD devices, all common communication channels in properties are open. Interaction within a Saia PCD system is inherently guaranteed (S-Net). Interacting with external devices is easy. This enables total integration with all systems and building services. It is the basis on which the full optimisation of operational efficiency and reliability is built.

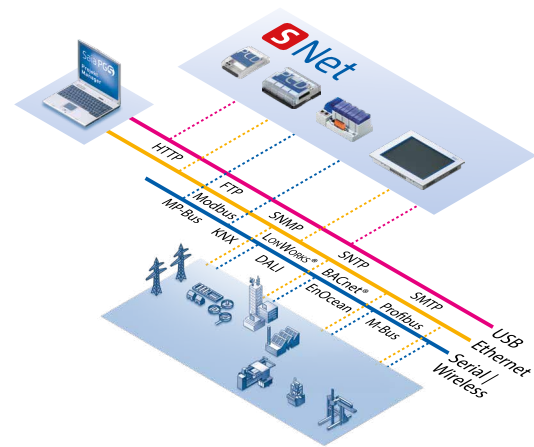

2.1 The basic features of Saia PCD® communication systems

Page 188

Onboard protocols, communications options for expanding operating systems, communication drivers in the application program, IP-based protocols, serial protocols with standard interfaces, dedicated communication systems

2.2 Overview of Saia PCD® communication systems

190

An overview of Saia PCD controllers with onboard interfaces and modular expansion capabilities

2.3 Saia Web/IT protocols

192

Web and IT protocols for easy integration into the following IT architectures: DHCP, DNS, SMTP, SNMP, FTP, HTTP, ...

2.4 Wide Area Automation with Saia PCD®

198

Protocols and services for the integration of a Saia PCD into public networks. Internet, ADSL, GSM, GPRS, UMTS, modem, ... security

2.5 S-Net

200

S-Net for communicating between SBC devices

- | | |
|--|--|
| 2.5.1 The basic features of S-Net | 2.5.4 Profi S-Net: Profi S-Bus, Profi S-IO |
| 2.5.2 Ether S-Net: Ether S-Bus, Ether S-IO | 2.5.5 Profibus |
| 2.5.3 Serial S-Net:
S-Bus on serial RS-xxx interfaces | |

2.6 BA communication systems

206

Communication standards for all building services

- | | | |
|---------------|---------------|---|
| 2.6.1 BACnet | 2.6.4 EnOcean | 2.6.7 MP-Bus |
| 2.6.2 Modbus | 2.6.5 M-Bus | 2.6.8 Additional communication drivers for connecting to external systems |
| 2.6.3 KNX/EIB | 2.6.6 DALI | |

2.1 The basic features of Saia PCD® communication systems

Saia PCD systems provide communication protocols suitable for all levels of the automation pyramid to integrate a PCD into the communication infrastructure of a building. In addition to performing regulation and control tasks, the PCD is often used for connecting different systems from different building services. Regardless of the type of interface, it is recommended to use only standardised communication systems for heterogeneous systems. From experience, compatibility and sustainability are better solved using standard technologies rather than closed solutions from a single manufacturer. The following diagram illustrates the essential differences between communication systems, from the field to the management level.

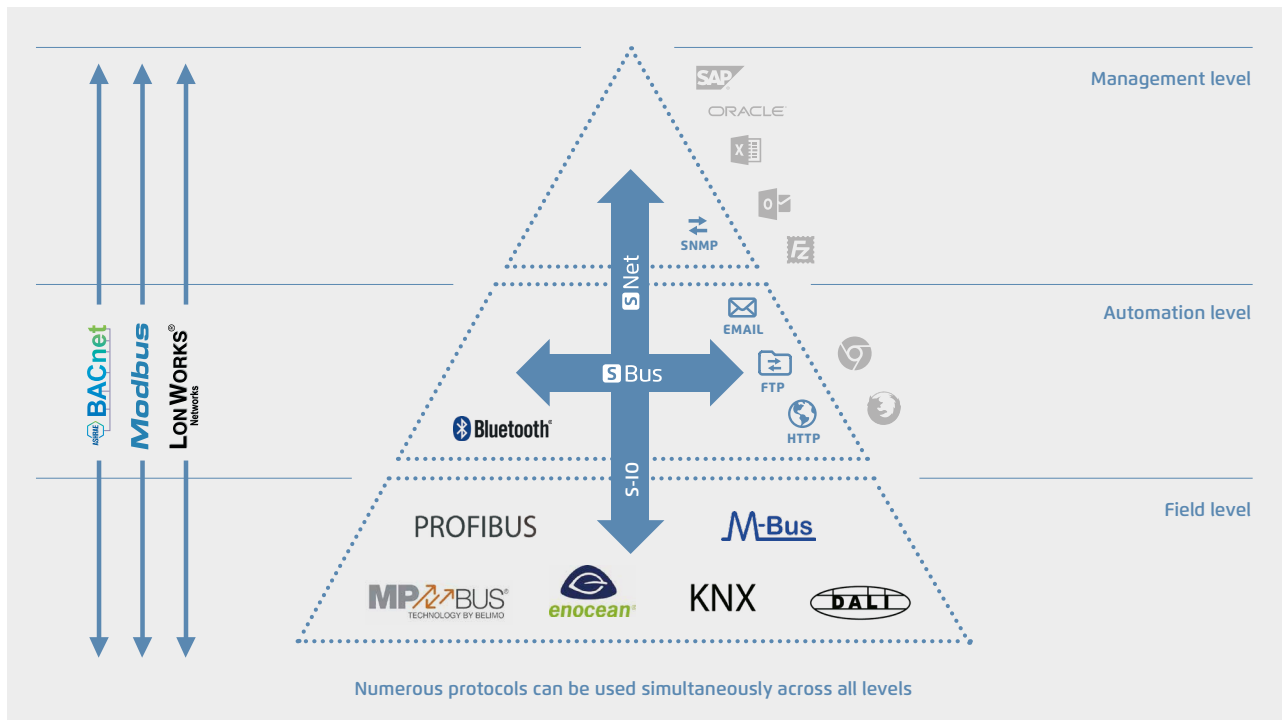

IP-based protocols

IP-based protocols are mainly used for connecting controllers to management systems. IP protocols are also used to exchange data between automation devices and with local control devices. For example, BACnet is very good for communicating between automation devices and the management system. Web and IT services such as DHCP, DNS, SNTP, SNMP and SMTP (emails) are reliable tools in the integration of automation devices into the IT infrastructure. Web-based visualisations with suitable web servers and a CGI-bin interface in the automation device also provide a sustainable basis for operation and service over the entire service life of a system.



Serial protocols with standard interfaces

Field components mainly use serial protocols equipped with standardised interfaces such as RS-232, RS-485 or RS-422. Despite the low baud rate, these interfaces have the advantage over Ethernet as they are easy to install. Cable and infrastructure components such as repeaters are cheaper than a complete IT infrastructure. Field bus systems are also easier to service and maintain.



Dedicated communication systems

It is practical to use a dedicated hardware interface for certain field devices. These systems are optimised for particular tasks. DALI is suitable for controlling lighting for example, and M-Bus is designed for connecting meters. However, these systems should not be used for communication between automation stations.



Saia PCD® systems

Saia PCD systems offer solutions for almost all conventional building automation system protocols. Depending on the protocol and interface, they are supplied with the Saia PCD operating system or can be installed in the application program. Saia PCD controllers can therefore also be used as gateways between building services and plant which would otherwise remain separate.

Onboard protocols

Saia PCD systems are based on SBC's proprietary Saia PCD COSinus operating system. The operating system makes certain protocols directly available, in particular Web and IT services as well as S-Net. These protocols can be used on every Saia PCD controller. Depending on the protocol, FBox libraries are available in the application program.



Communication options as an operating system expansion

For many protocols it is worth offering them as an option, particularly if the protocols are not required globally in every application and require a large amount of memory in the controller. For example, BACnet® are available to expand the operating system. These are software components which are used as integral components of the operating system, which differentiates them from gateways.



Communication drivers in the application program

At the core of every Saia PCD is a PLC controller. The application program can be fully configured to enable numerous infrastructure automation protocols to be integrated direct into the application program. This provides almost limitless flexibility.



	Compact		
	PCD1 E-Line programmable RIO ⁷⁾		
	PCD1.G1100-C15	PCD1.F2611-C15	PCD1.W5300-C15
I/O data points			
Onboard (data points)	8	4	8
Maximum number of I/Os ¹⁾	8	4	8
Maximum number of interfaces (incl. PGU)	2	3	2
Onboard interfaces			
RS-485, S-Bus, PGU up to 115 kBit/s (Port #0)	•	•	•
USB 1.1 device, PGU	•	•	•
RS-485 up to 115 kBit/s (Port #2)	–	• ⁸⁾	–
Optional interfaces			
DALI-Master		•	



¹⁾ I/O slots can be fitted with I/O modules as required (see pages 21 and 29). The number of data points processed by a PLC depends on the number of I/O data points per module. A max. 16 data points per module are possible. A PCD can therefore process a maximum number of data points of 64 I/O slots × 16 data points/slot = 1024 I/O data points.

²⁾ A PCDx.R56x memory module is always required to use BACnet®. Controllers support BACnet MS/TP using optional PCD2.F2150 or PCD3.F215 communication modules.

Controller	Memory module	max. free I/O slots
PCD3.M3xx0	PCD3.R562	3
PCD3.M5xx0 PCD2.M5xx0 PCD2.M4560	PCD7.R562	4
PCD2.M4160 PCD1.M2xx0	PCD7.R562	2
PCD1.Mxxx0	PCD7.R562	---
PCD1.Room	PCD7.R562	1

⁵⁾ Electrically connected

⁶⁾ Electrically isolated

⁷⁾ Programmable E-Line modules are optimised for your application and therefore do not have all the functions of a Saia PCD system available with the COSinus operating system. For specifications on the program memory and available PLC media (flags, registers, etc.), see data sheet.

⁸⁾ The second onboard RS-485 interface supports "Mode C" with no interpreted text, for example EnOcean, ...

2.3 Web and IT protocols for integration into IT infrastructures

All Saia PCD controllers have an integrated automation server with open standard Web/IT interfaces. Saia PCD are easy to integrate into existing software infrastructures with no additional outlay required using the standard communication protocols. Specific drivers or systems are not required. Standard tools such as web browsers, FTP clients and SNMP managers, etc., are used to access the data in the PCD controllers.

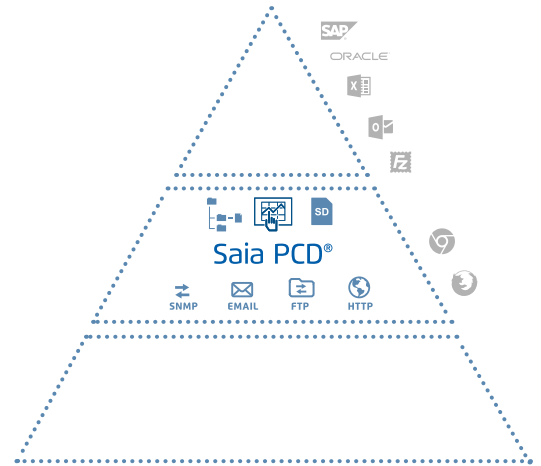
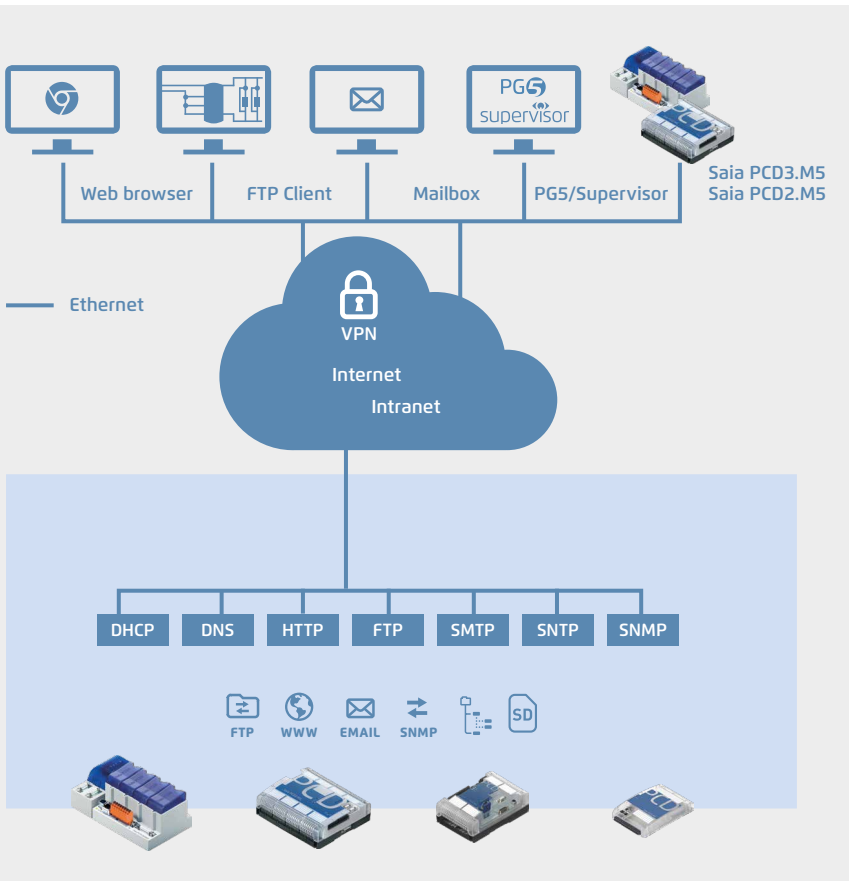

The standard Web/IT protocols enable Saia PCD systems to be universally integrated across all levels in existing IT infrastructures with no additional outlay required.

An overview of Web/IT protocols supported by the automation server. Access is provided via the Ethernet interface or via serial interfaces using the PPP protocol.

DHCP: Dynamic Host Configuration Protocol

Protocols for automatically configuring the Ethernet communication. It is no longer necessary to enter the communication parameters manually as they are assigned directly from a central server.

A DHCP client automatically receives the IP address, subnet mask, gateway and DNS address parameters on request. The devices in the existing network are integrated automatically.

The devices are integrated in the existing network with no knowledge of the network parameters. Service personnel can also exchange devices with no technical background or knowledge of the specific network data required.

Standard	RFC-2131
Port	UDP 68 for client
Assigned attributes	IP address subnet mask standard gateway (optional) DNS address (optional)

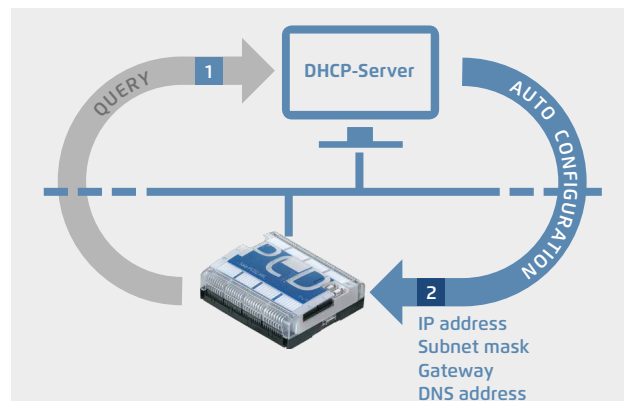

DNS: Domain Name System

Access to the controllers using set naming conventions. When establishing communication between two controllers, there is no need to know the IP address of the target controller, only its name. The IP address can be requested from a DNS server using this name. Devices are no longer controlled using meaningless IP addresses. The structure and availability of individual networks is specified once, and need not be constantly adjusted in accordance with the available IP addresses. This makes the systems easier and more intuitive to use. Networks involving several participants can be documented more clearly.

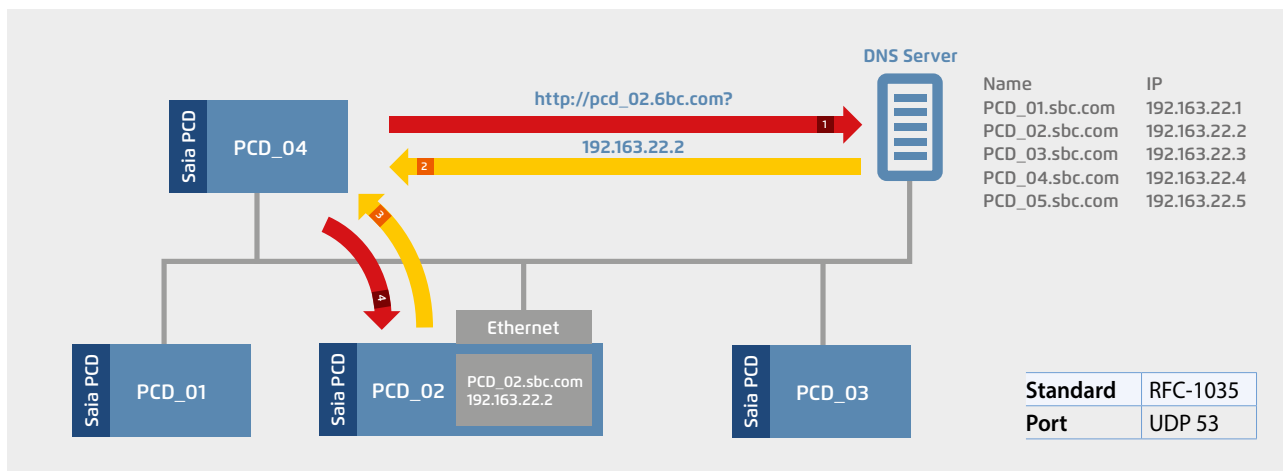

Examples using DHCP and DNS

Integrating devices into networks is easy. A DHCP client automatically receives the network parameters from a DHCP server. This means that controllers can be integrated into existing networks with no knowledge of the network parameters required. The controller is simply accessed using the name.

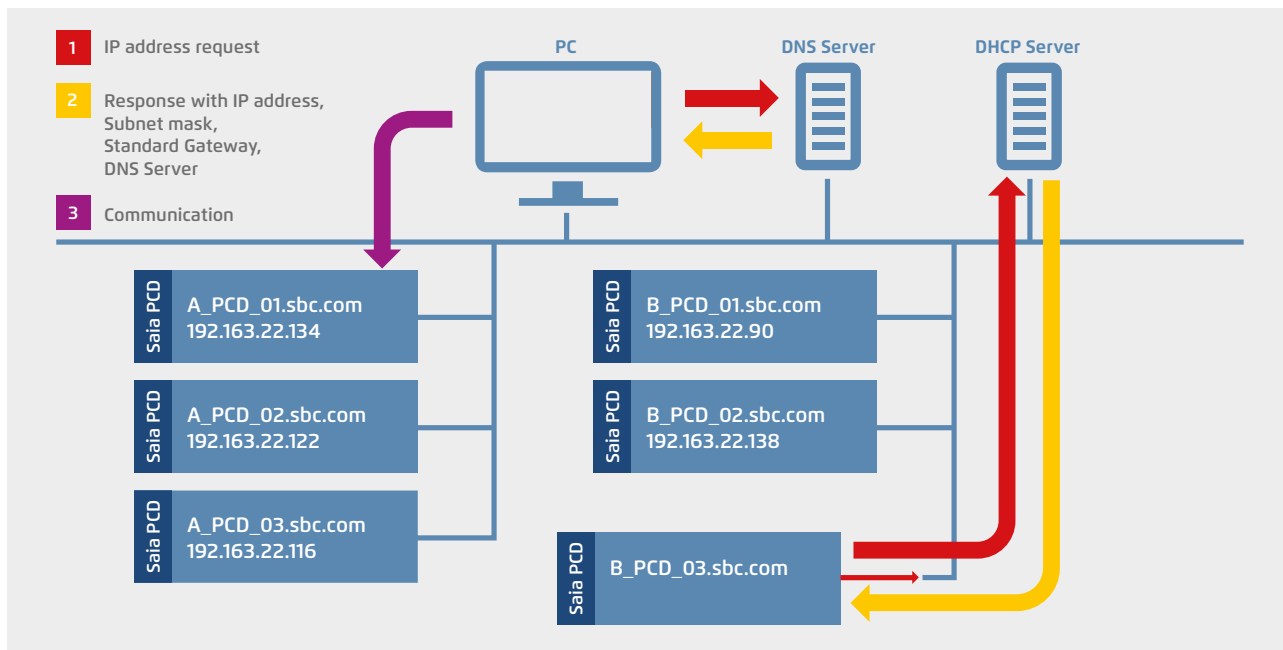

Configuration

Basic activation and configuration of DHCP/ DNS in the PG5 device configurator.

DHCP Client Protocol	
DHCP Client Enabled	Yes
Automatic Gateway IP Setting	No
Automatic DNS IP Setting	No
DHCP Server IP to Reject 1	0.0.0.0
DHCP Server IP to Reject 2	0.0.0.0
Host Name	
Fully Qualified Domain Name	

DNS Client Protocol	
DNS Client Enabled	Yes
DHCP Information Enabled	No
Primary DNS Server IP Address	0.0.0.0
Secondary DNS Server IP Address	0.0.0.0
Response Timeout [ms]	1000

FBoxes

Specific network administration FBoxes can be used to distribute the DNS names of other stations via the application program and verify communication with the PING FBox.

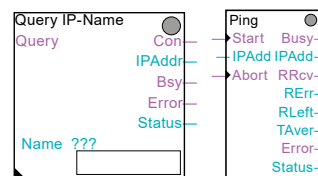

SNTP: Simple Network Time Protocol

The Simple Network Time Protocol is a standard used to synchronise the time across several devices in IP networks. The protocol enables the transmission of the current time of servers in the Internet or Intranet. Sophisticated algorithms ensure that the different run times are balanced out across a network. The internal system clocks (RTC) and the changeovers between summertime and wintertime are synchronised automatically for all network participants at the same time.

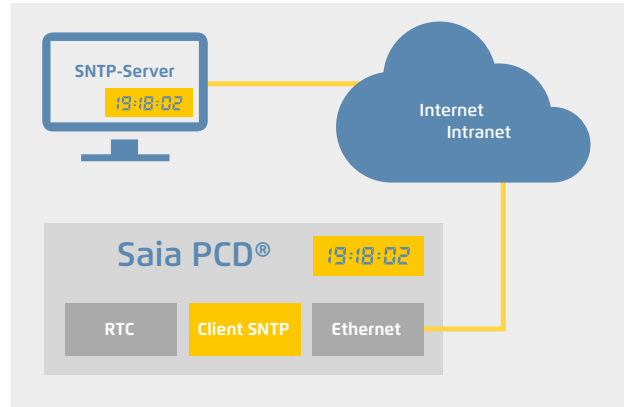

Standard	RFC-2030
Port	UDP 123
SNTP mode	Unicast point-to-point (SNTP client initiates a time request) Broadcast point-to-point (the time is sent from the NTP server simultaneously to all clients)
Time format	UTC (Greenwich Mean Time), adjustable time zone
Timing accuracy	500 ms for Unicast point-to-point 1 s for Broadcast point-to-point (without run time correction)
Request interval	10 s
Interfaces	Ethernet or serial RS-232 via PPP

FBoxes

The status of the SNTP function can be read and/or reset using specific FBoxes.

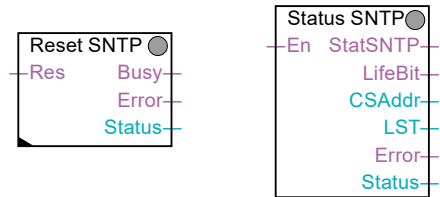

HTTP: Protocol for accessing the PCD Web Server

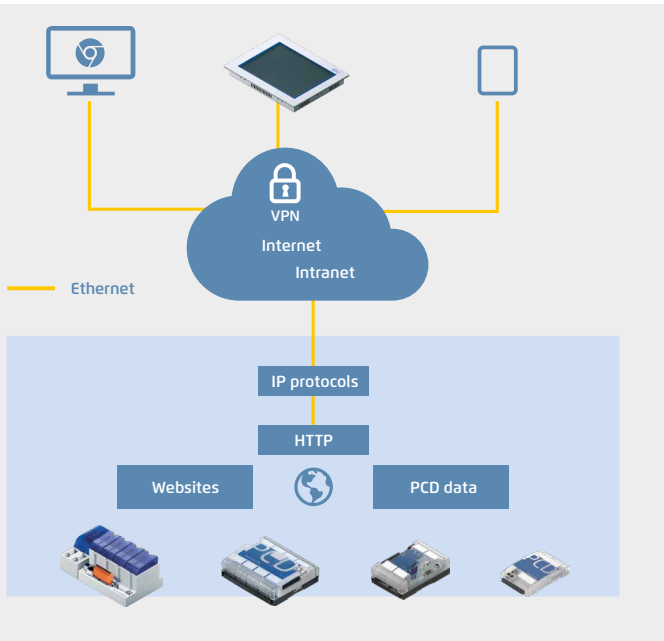

Hypertext Transfer Protocol (HTTP) is a protocol used for transferring data over a network. With Saia PCD, the protocol is used for accessing the PCD web server.

PG5 device configurator settings

- ▶ Activating/deactivating the HTTP port
- ▶ Advanced settings (buffer, sessions, keep alive timeout, etc.)

HTTP Direct / First Listener	
HTTP TCP/IP Port Enabled	Yes
TCP Port Number	80
+ Advanced Parameters	Hide
HTTP Direct / Second Listener	
HTTP TCP/IP Port Enabled	Yes
TCP Port Number	81
+ Advanced Parameters	Hide

Technical data

HTTP standard	1.0 and 1.1 (RFC 2616)
2 adjustable listener ports	Standard 80 and 81
Number of sessions	8 parallel with keep alive (standard setting, max. 32 adjustable)
Interfaces	Ethernet, serial RS-232 with PPP, the HTTP protocol can also be encapsulated in the S-Bus and therefore used via other interfaces such as USB. Please refer to chapter B3 S-Web technology for details

FTP: Protocol for transferring files

The File Transfer Protocol (FTP) is used to load files into or read files from PCD devices via the network. Files (websites, log data, documents, etc.) are saved in the file system of the PCD devices. User groups and passwords can be set up to protect access to the FTP server and individual files (e.g. read only).

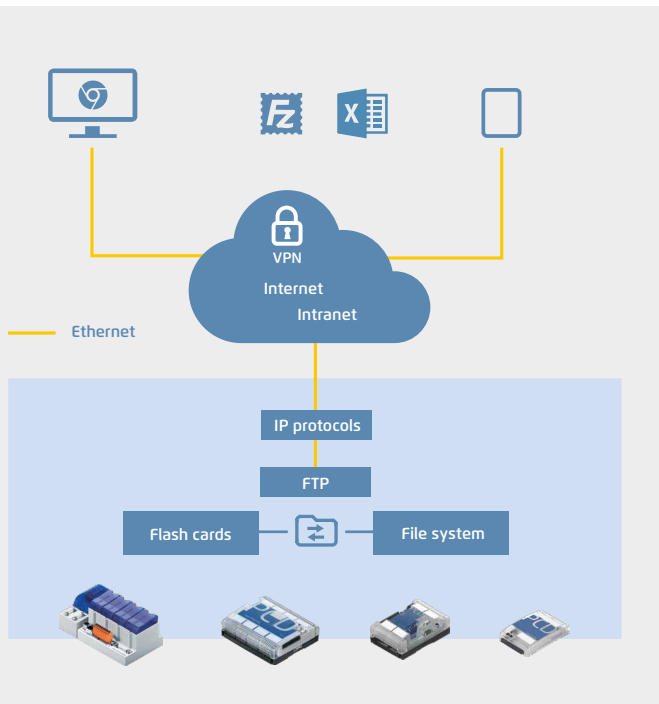

PG5 device configurator settings

- ▶ Activating/deactivating the FTP server
- ▶ Configuring port numbers (standard port: 21), user and access rights
- ▶ Advanced settings (no. of connections, timeout, etc.)

FTP Server	
FTP Server Enabled	Yes
TCP Port Number	21
User Name 1	
User Name 2	
+ Advanced Parameters	Hide

Technical data

FTP standard	RFC 959
Standard port number	21 (can be set) plus dynamic port (> 1023) for data
Connection mode	PCD devices only support the active FTP mode
Number of FTP connections per PCD	Standard 3 (max. 5 adjustable)
Interfaces	Ethernet, serial RS-232 with PPP

! Active/passive FTP mode

PCD devices only support the active connection mode! The client establishes a connection to server port 21 and provides the server with the port number for the data channel. Unlike in passive mode (here the port for the data channel is always 20), this port number is not specified and can be in the range > 1023. This often causes problems with firewalls, as these port numbers are not approved.

Another means of transferring files is to use FTP CGI (Common Gateway Interface) interfaces in the web server. If the respective syntax is known, it is also possible to transfer data between a web client and PCD devices via this interface. For more information on this please refer to Chapter B3 S-Web.

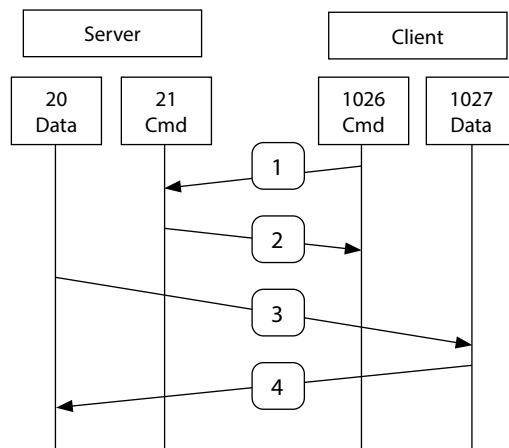

SNMP: Simple Network Management Protocol

The Simple Network Management Protocol was developed to be able to monitor and control network elements such as routers, servers, switches or even Saia PCD (agents) from a central station. The SNMP manager software generally runs on a server. It monitors and controls the SNMP agents. The SNMP manager reads and sends data from agents using SET and GET commands. The SNMP agent can also send "trap" messages to the SNMP manager unrequested. This allows faults to be reported immediately, for example.

The Saia PCD MIB has been specified for Saia PCD with SNMP support. It includes all resources which can be requested and changed using SNMP. It is possible to access all PCD media (inputs/outputs, registers, flags, DBs, etc.). In the MIB file, the programmer is able to restrict access to selected areas only. The MIB II standards for managing the TCP/IP functions defined in accordance with RFC1213 are also supported.

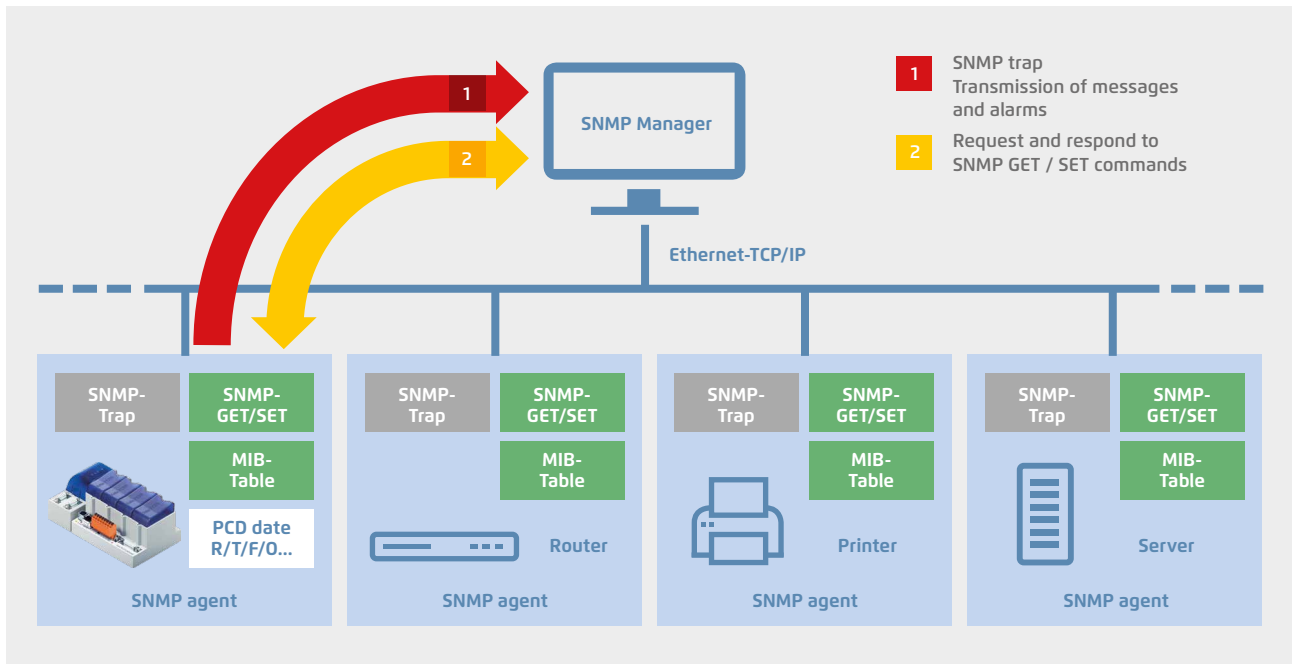

Configuration

Simple activation and configuration of the SNMP functionality in the PG5 device configurator. Up to 3 SNMP trap receivers can be configured. The data fields to which the SNMP manager has access are also configured here.

SNMP (Simple Network Management Protocol)	
SNMP Enable	Yes
sysContact Message	Saia Burgess Controls AG
sysLocation Message	CH-3280 Murten
Life Trap Interval [ms]	0
Trap 1 Port Number	0
Trap 1 IP Address	172.23.14.141
Trap 2 Port Number	0
Trap 2 IP Address	172.23.14.192
Trap 3 Port Number	0
Trap 3 IP Address	0.0.0.0
+ Advanced Parameters	Hide

FBoxes

Trap messages with integer or Boolean data or text information can be conveniently sent to the trap receivers using FBoxes.

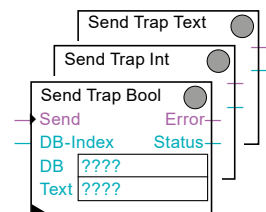

SBC MIB File Generator

The MIB file contains pre-defined SNMP strings for accessing the PCD data (register, flag, DB, etc.) with the SNMP manager. The MIB files can be generated with project-specific symbol names using the MIB file generator (available with PG5 V2.1).

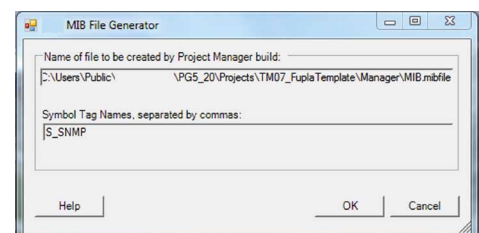

Technical Data

SNMP Standard	V1 and V2c (RFC 1157)
	MIB II standard in accordance with RFC 1213 is supported
Standard Ports	#161 and #162

SMTP: Protocol for sending emails

The email function and integrated SMTP client (Simple Mail Transfer Protocol) can be used to send PCD device process and system information to an email server. This enables alarm, service and status messages, log data or any form of process information to be sent via email to a control centre or service personnel.

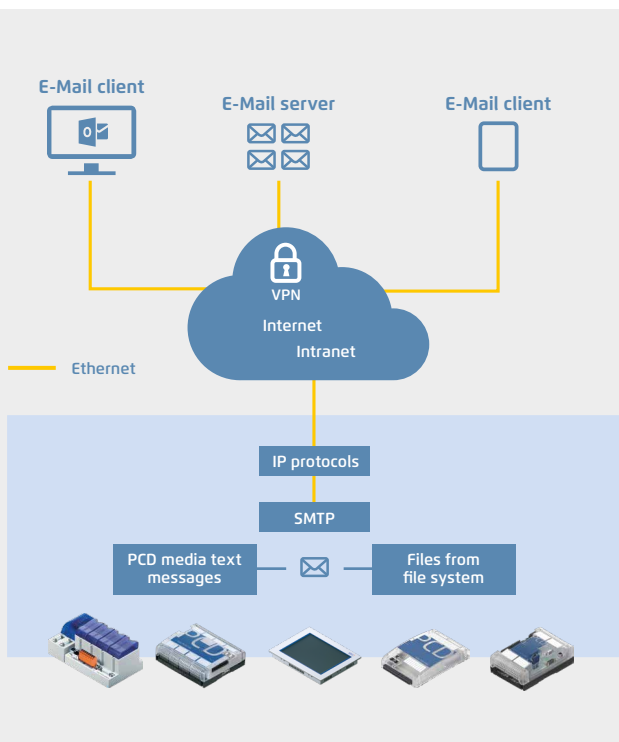

FBoxes

FBoxes are available for sending emails using the application program. The email function is configured (mail server, port number, user and password, etc.) via these F boxes. It is also possible to send file attachments (e.g. log data) of up to 1 MByte.

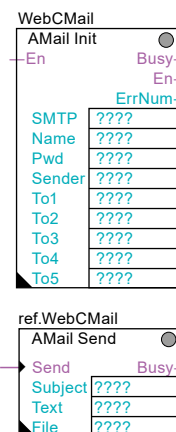

Technical Data

SMTP Standard	RFC 821, 822
Standard port number	25 (adjustable) + 587
Server authentication	"AUTH LOGIN" or "AUTH PLAIN" in accordance with RFC 2595 (unencrypted transmission of password)
Email format	Text or HTML
Interfaces	Ethernet, serial RS-232 with PPP

PPP: Point-to-point protocol

This is a protocol established along a communication route from one point (location) to another. PPP is a protocol that is mainly used to transport TCP/IP protocols via a serial cable or modem connection. CHAP (Challenge Authentication Protocol) was introduced to meet the greater security requirements when dialling into company networks or systems with critical tasks.

The user has access to the web and FTP server via a telecom interface (PSTN, ISDN, GSM/GPRS) in the Saia PCD controller. This also applies to applications with more economical devices and no Ethernet connection.

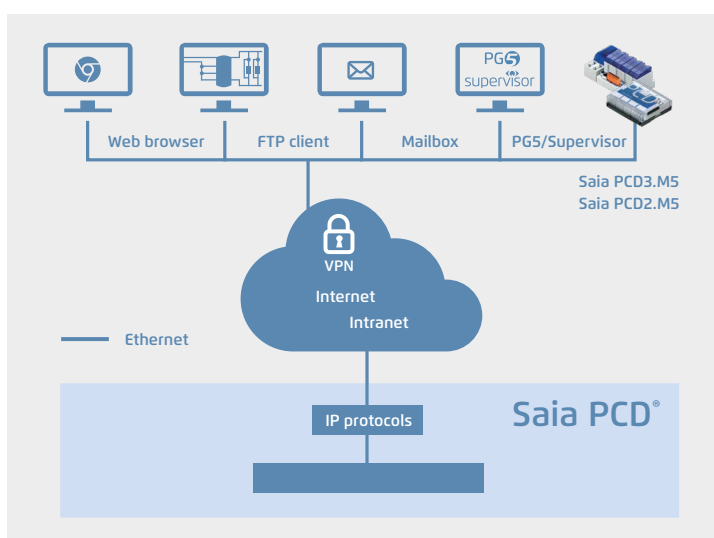

Standard	RFC-1661
Authentication	PAP, CHAP and MS CHAP
Simultaneous PPP connections	Only one PPP connection (client or server) can be active per Saia PCD® controller.
PPP via Ethernet	No

2.4 Wide Area Automation with Saia PCD®

Spanning geographical distances with a larger number of substations often places significant demands on a system. The integrated automation server can be used to combine geographically distributed systems easily using the Internet and Intranet. This allows the systems to be monitored and controlled remotely. It is possible to access the controllers directly during commissioning or servicing.

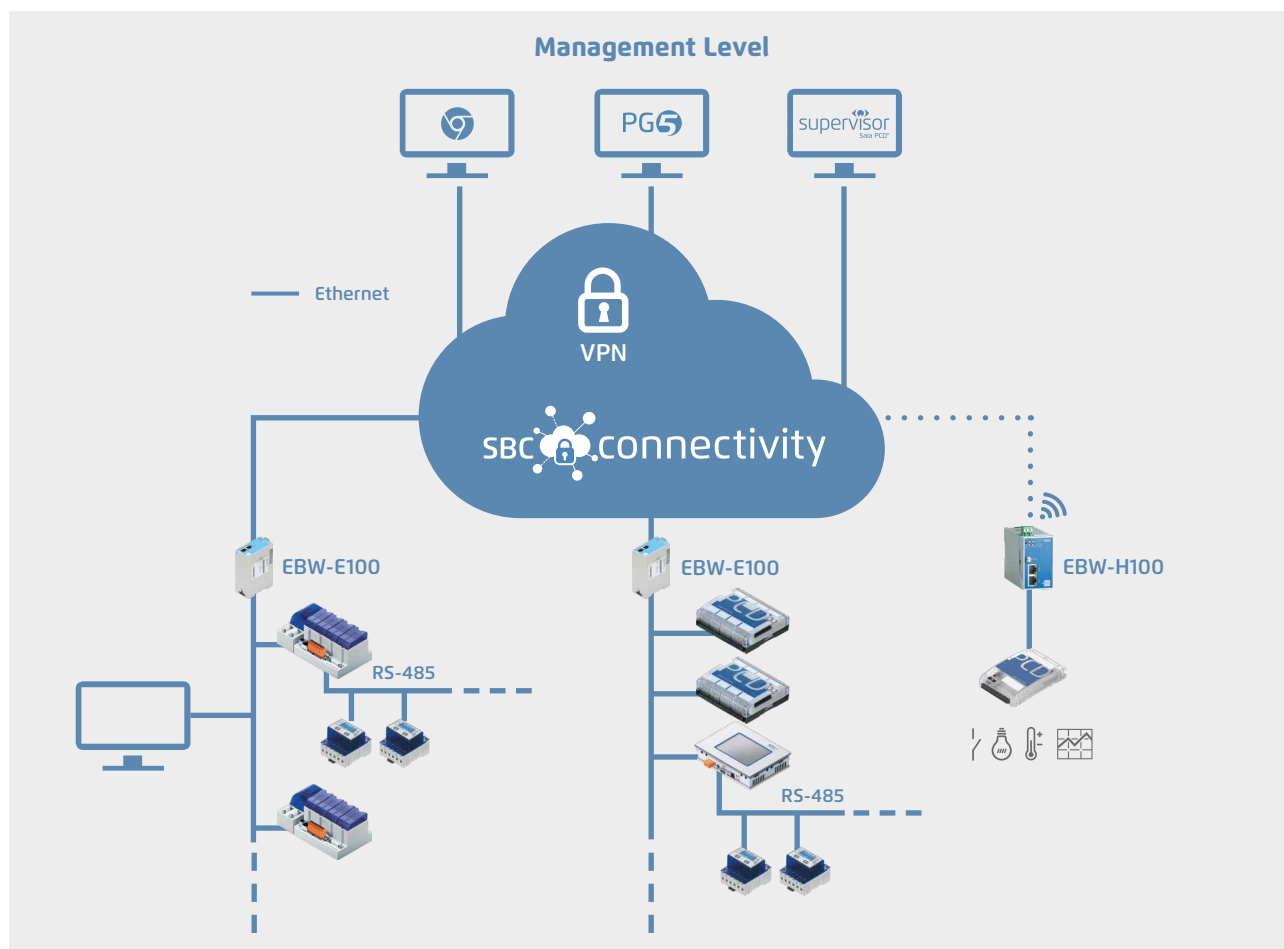

Networks for Wide Area Automated Systems

PCD controllers support the connection to the WAN (Wide Area Network) via all established telecommunication technologies. The IP-based protocols (automation servers) are used to connect direct to the Internet either wired via Ethernet interfaces and DSL broadband routers or wirelessly with GPRS/UMTS routers. Non-IP based connections with analogue, digital (ISDN) or GSM modems are also supported.

Protocols and services

The WEB/IT protocols are used to support access to the automation server functions (web/FTP server, email, SNMP, etc.).

The S-Bus protocol enables communication with the PG5 programming device, the SBC OPC server or Saia PCD® Supervisor.

S-Bus is also used to exchange data between PCD controllers via the WAN.

Other IP-based protocols such as Modbus TCP and BACnet® are also supported.



Connection of Saia PCD® controllers to the Internet

When Saia PCD controllers are connected directly to the internet, they are also a potential target of cyber attacks.

Appropriate protective measures must always be taken to ensure secure operation.

Saia PCD controllers include simple, integrated protection features. However, secure operation on the internet is only ensured if external routers, like the industrial Routers EBW-E100 and EBW-H100 are used with a firewall and encrypted VPN connections.

For more information, please refer to our support site: <http://sbc.do/Me4rLqwE>

Saia PCD® secure on Internet with VPN-Routers and “SBC Connectivity Portal”

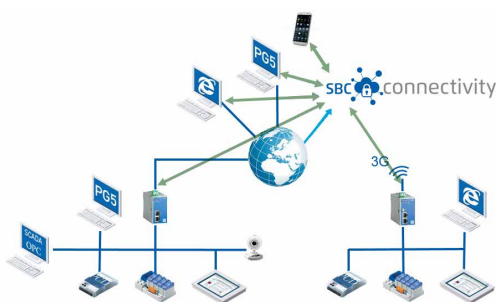

With the “SBC Connectivity Service”, you will get your own encrypted VPN. In just a few steps, you’ll integrate locally connected PCD controllers, Web panels MB as well as PCs, tablets or smartphones. All your devices can be accessed across all networks and addressed at any time with this.

The necessary certificates are generated and assigned to the EBW router by the “SBC Connectivity Portal” directly. The routers get the complete VPN configuration transmitted automatically using a quick start wizard. It couldn't be simpler and more comfortable!

With the “SBC Connectivity service” you have your VPN under complete control - with minimum investment. It starts to pay off with the first device already. Furthermore, the new web proxy enables secure access to web services in your VPN without a licence.



Keys features:

- ▶ Allows a M2M communication between systems located on different sites
- ▶ Provides a secure data transmission
- ▶ No needs of public IP address
- ▶ Doesn't require deep IT knowledge



Of course, the EBW industry routers could also be used independently of «SBC Connectivity Portal», for example for a point to point connection.

Products for Wide Area Automation

Q.NET-CON	Annual license for one VPN connection on the “SBC Connectivity Service” portal										
Q.NET-EBW-E100	Industrial LAN router for VPN connection										
Q.NET-EBW-H100	Industrial 3G/HSPA Router for VPN connection										
PCD7.K840	Antenna with magnetic foot GSM/UMTS (700/800/850/900/1'700/1'800/1'900/2'100/2'600 MHz)										
	<table border="0"> <tr> <td>Height</td> <td>Diameter</td> <td>Cable</td> <td>Connector</td> <td>Protection class</td> </tr> <tr> <td>7,2 cm</td> <td>3,1 cm</td> <td>3 m</td> <td>SAM (male)</td> <td>IP65</td> </tr> </table>		Height	Diameter	Cable	Connector	Protection class	7,2 cm	3,1 cm	3 m	SAM (male)
Height	Diameter	Cable	Connector	Protection class							
7,2 cm	3,1 cm	3 m	SAM (male)	IP65							

FBoxes for modem communication and sending emails

Communication via GSM, PSTN or ISDN modems is supported via a comprehensive FBox library. SMS messages can be sent and received.

```

ref.CallsMS
Send SMS
-Cal
Msg      ????
```

FBoxes are available for sending emails using the application program. Alarm, status and text messages can be sent. Sending file attachments (e.g. log data) is also supported.

```

WebCMail
AMail Init
-En
Err
ErrNum
SMTP
Name  ????
```

*In preparation, see Chapter C1 “Product status”

2.5 S-Net for communicating between Saia PCD® devices

2.5.1 The basic features of S-Net

S-Net incorporates the S-Bus and S-I/O system protocols for communicating between SBC devices. Both protocols are optimised for SBC devices and compared to other standard protocols (e.g. Modbus) offer more functionality and can be used more simply and efficiently in the application.

S-Bus supports all services and functions regarding the exchange of data, programming, commissioning and service of Saia PCD controllers. The S-Bus protocol does not depend on the physical aspects and can be used on Ethernet, USB, Profibus-FDL and serial interfaces (RS-232, RS-422, RS-485).

The **S-IO** protocol supports the operation of SBC remote I/O stations with Ethernet (PCD3.T66x).

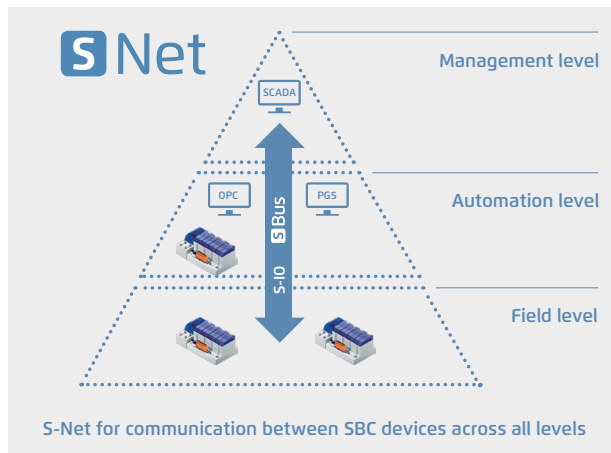

Services and functions using S-Bus

Programming and commissioning

S-Bus is the programming device system protocol. It supports all programming, commissioning and diagnostic functions.

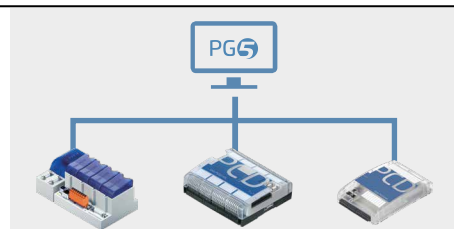

Access with the programming device via Ethernet, USB or serial interface

Exchanging data between PCD controllers

S-Bus supports the transmission of all PCD media (register, flags, timer/counter, database and text) and is optimised for the exchange of data between PCD controllers, whereby Ethernet and Profibus allow multi-master operation. Serial interfaces (RS-232, RS-422, RS-485) enable "single"-master slave mode or S-Bus master multiple slave mode.

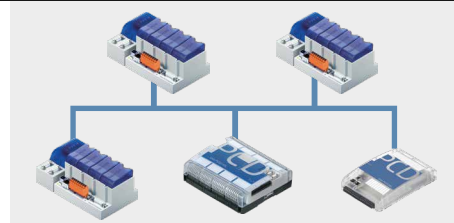

Exchanging data between PCD controllers via Ethernet, Profibus or serial interfaces

Visualisation with OPC servers and SCADA systems

S-Bus together with an OPC Server or the SBC.Net-Suite supports access (reading and writing) to all PCD data with a Windows SCADA system.

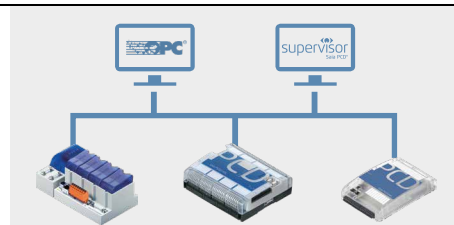

Connecting to SCADA systems via Ethernet, USB, Profibus or serial interfaces

Visualisation with web browsers

S-Bus supports HTTP protocol transmission. This also allows websites to be transmitted together with "SBC Web.Connect" via USB and serial interfaces and displayed on a Windows PC with the standard web browser or a micro browser web panel.

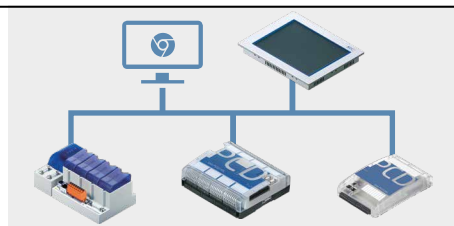

Access to the PCD web server is also possible via USB and Serial interfaces

2.5.2 Ether S-Net: S-Bus and S-IO protocol with Ethernet

The Ether S-Bus and Ether S-IO protocols support the operation of Saia PCD controllers and Smart RIOs on Ethernet. The PCD devices can be integrated and operated in a standard Ethernet network (along with other devices). Multi-protocol operation is supported on the same connector and cable. That means that all IP protocols (e.g. access to the automation server) can be used in parallel with S-Bus and/or S-IO.

Ether S-Bus for operating PCD controllers with Ethernet

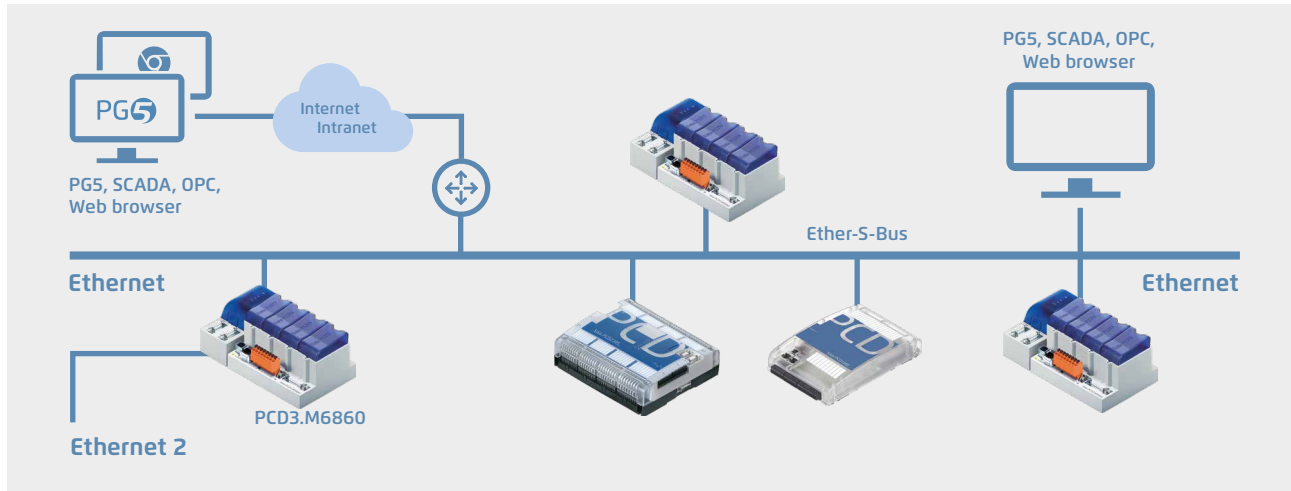

Ether S-Bus protocol in the multi-master operation on a standard Ethernet network

Properties, functions

- ▶ Ether S-Bus supports communication between
 - PCD controllers in multi-master operation
 - a PCD controller and the PG5 programming device
 - a PCD controller and the OPC server or SCADA system with Ether S-Bus drivers
 - a PCD controller (PCD WebServer) and web browser with Web Connect software
- ▶ Programming the data transfer between PCD controllers with FBoxes for cyclic or event-controlled data transfer
- ▶ Multi-protocol operation on the same Ethernet connection (e.g. Ether S-Bus, Ether S-IO and other protocols such as Modbus TCP)
- ▶ Gateway function for gateways (Ether S-Net ↔ Serial S-Net, Ether S-Net 1 ↔ Ether S-Net 2, Ether S-Net ↔ Profi S-Net)
- ▶ The PCD3.M6860 CPU can be used to construct separate networks or redundant Ethernet networks
- ▶ The network can be constructed using standard Ethernet components
- ▶ IP protocol: UDP
- ▶ Port number: 5050 (a firewall may require this port to be activated)

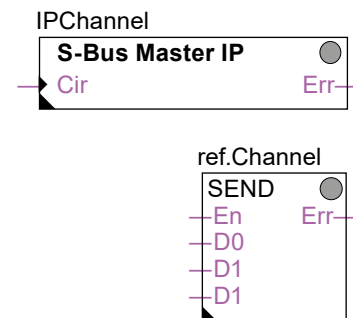

Ether S-IO for operating Smart RIOs PCD3.T66x

Properties, functions

- ▶ Ether S-IO supports the exchange of data between Smart RIO Manager and the Smart RIOs. Ether S-Bus is used to transfer the configuration and all programs
- ▶ It uses broadcast or unicast telegrams (adjustable)
- ▶ The data transfer is configured by the RIO network configurator
- ▶ Multi-protocol operation is supported
- ▶ The network can be constructed using standard Ethernet components
- ▶ IP protocol: UDP
- ▶ Port number: 6060

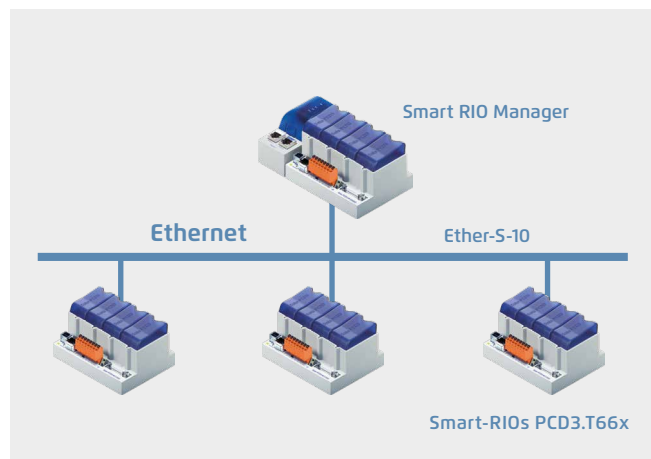

Ether S-IO protocol for operating Smart RIOs with Ethernet

Constructing Ethernet networks separately or redundantly with PCD3.M6860

The PCD3.M6860 CPU has two independent Ethernet interfaces which are used to construct physically separate networks (e.g. company or automated system networks) or redundant networks. The second interface has an additional 2-port switch.

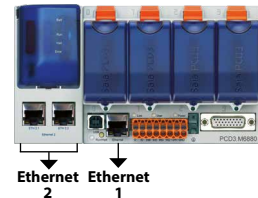

Properties, functions

- ▶ The technical data of the PCD3.M6860 are identical to those of a PCD3.M5560, apart from the second Ethernet interface (instead of the serial interfaces)
- ▶ The Ethernet interfaces are separate and both have an independent IP configuration. The IP addresses must not be in the same subnet. IP routing between the two interfaces is not supported.
- ▶ All IP protocols are supported on both interfaces. This enables access to the automation server and the PCD data via both interfaces. Access to the PG5 programming tool is also supported on both interfaces.
- ▶ BACnet is only supported on one interface (1 or 2)
- ▶ The S-Bus gateway function between the two Ethernet interfaces is also supported

Separating Ethernet networks

It is worth physically separating networks when:

- ▶ The automation devices and the standard IT devices (PC, server, etc.) must not be operated on the same network for security reasons. In this instance, the PCD3.M6860 functions like a “firewall” as only S-Bus telegrams can be transmitted from one interface to another. Other IP telegrams are not routed.
- ▶ The data traffic cannot take place in the same physical network for performance reasons
- ▶ The infrastructure (e.g. network cabling) must be isolated

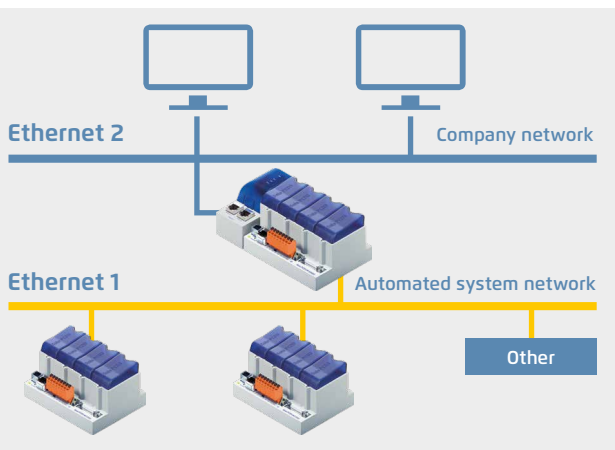

The automated system and company networks are physically separate

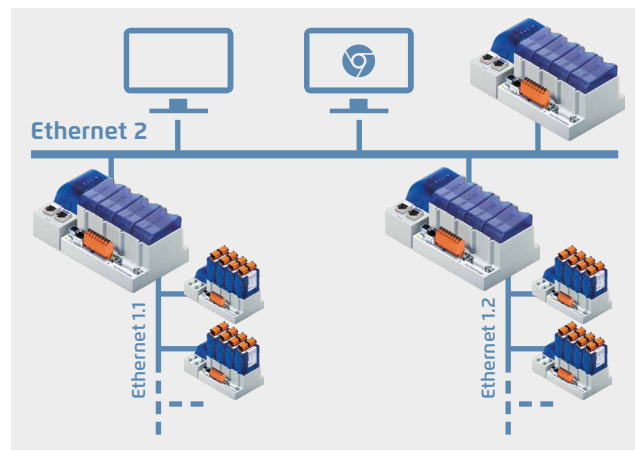

The automation network can be divided into several physical networks for improved structuring and an increase in availability and performance.

Constructing redundant Ethernet networks

Network redundancy is often required by systems with high demands placed on them in terms of operational availability, such as tunnel controllers in traffic technology or on ships, for example. The two Ethernet connections provide the PCD3.M6860 with connection redundancy. Standard components (switches and cables) can be used to construct separate, redundant networks. The networks and choice of interfaces are monitored by the application program. The network availability can be expanded further by creating a fibre optic ring combined with specific switches and fibre optic cables. The switches automatically identify any interruptions in the ring and reroute the data traffic accordingly.

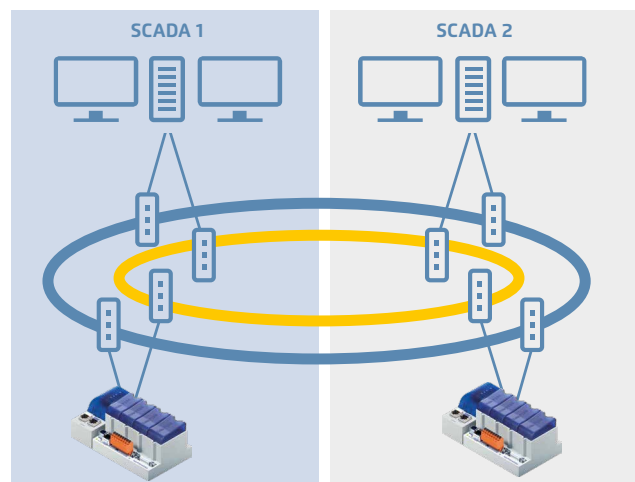

Highly available Ethernet with two fibre optic rings. In the event of an interruption, the switches automatically reroute the data traffic via the ring, which is still functioning. A defective switch or ring can be detected in the application program and the data traffic transmitted via the second ring or second interface.

2.5.3 Serial S-Net: S-Bus on USB and serial interfaces, RS-232, RS-422/485

The S-Bus protocol can be used on the USB and serial interfaces for communicating with Saia PCD controllers. This makes it possible to construct very simple, economical communication links and networks. Point-to-point (USB, RS-232) and 1:n communication relationships are supported in the RS-485 network in the master-slave operation.

S-Bus supports communication between

- ▶ PCD controllers in the master-slave (1:n) operation
- ▶ a PCD controller and the PG5 programming device
- ▶ PCD control and OPC server or SCADA system with S-Bus drivers
- ▶ a PCD controller (PCD WebServer) and web browser with Web Connect software

Point-to-point communication relationship with S-Bus

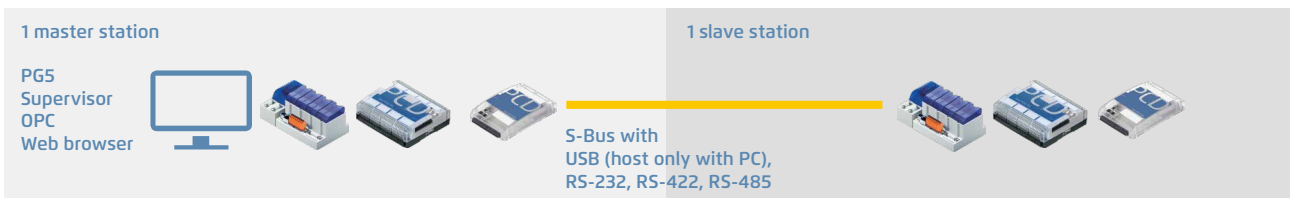

Properties, functions

- ▶ Interfaces: USB, RS-232, RS-422, RS-485 (can be used simultaneously on several interfaces)
- ▶ Baud rate: up to 12 MBit/s (USB standard 1.1)
- ▶ Communication relationship: Master-slave
- ▶ Exchange of data with a SCADA system with the SBC OPC server or an S-Bus driver
- ▶ Supports communication via modem (PSTN, ISDN, GSM) to RS-232 interface

1:n master-slave communication relationships in the RS-485 network with S-Bus

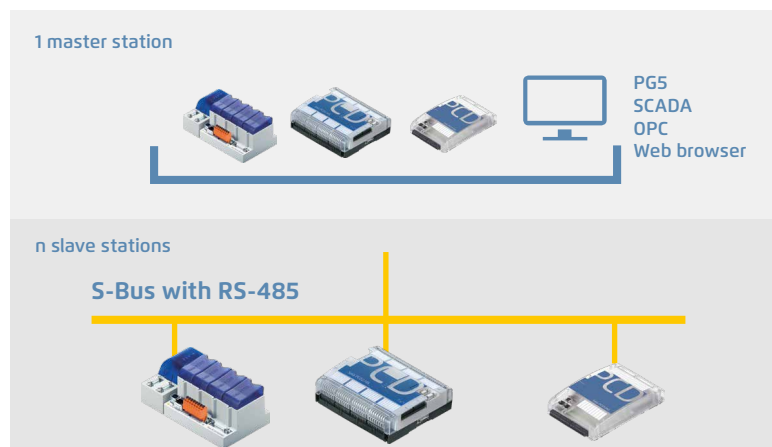

Properties, functions

- ▶ Interfaces: RS-485 (can be used simultaneously on several interfaces)
- ▶ Baud rate: up to 115 kBit/s
- ▶ Bus cable: 2-wire, twisted and shielded (min. $2 \times 0.5 \text{ mm}^2$)
- ▶ Bus length: max. 1200 m per segment
- ▶ Number of stations: max. 32 per segment, total max. 255
- ▶ Number of segments: max. 8, connected to each other via RS-485
- ▶ Communication relationship: Master-slave (only 1 master)
- ▶ Programming the data transfer between PCD controllers with FBoxes for cyclic or event-controlled data transfer
- ▶ Exchange of data with a SCADA system along with the SBC OPC server or an S-Bus driver

Note

The S-Bus protocol is also suitable for constructing multi-point wireless networks with external wireless modems. The wireless modems are connected to the RS-232 interface. The control cables can be used to control the wireless modem transmitters. Further information on this is contained in reference manual 26-739.



The proprietary S-Bus is designed for communicating with the Saia PG5® engineering tool, connecting to the management level/process control systems and for PCD ↔ PCD communication. It is not suitable or approved for connecting the field devices of other manufacturers. An open, manufacturer-independent field bus (e.g. Profibus, Modbus, etc.) is the correct solution for this.

2.5.4 Profi S-Net: S-Bus and S-IO protocols on Profibus FDL

The Profi S-Bus and Profi S-IO protocols support the operation of Saia PCD controllers on the Profibus FDL network. The protocols can be operated up to 1.5 MBit/s via the RS-485 interfaces integrated in the base unit. This enables economic and fast communication networks in multi-master operation. Multi-protocol operation is supported on the same connector and cable. The same selection of the bus parameters (baud rate, timing, etc.) enables the PCD devices to be operated along with devices from other manufacturers on one Profibus DP network.

Profi S-Bus for operating PCD controllers on Profibus FDL networks

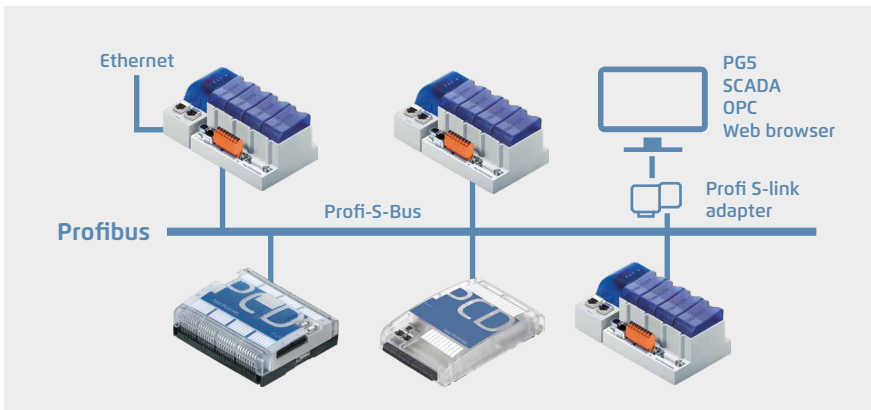

Profi S-Bus protocol in multi-master operation on a standard Profibus network.

Properties and functions

- ▶ Profi S-Bus supports the communication between
 - ▶ PCD controllers in multi-master operation
 - ▶ a PCD controller and the PG5 programming device (via Profi S-Link)
 - ▶ PCD control and OPC server or SCADA system with Profi S-Bus driver (via Profi S-Link)
 - ▶ a PCD controller (PCD Web Server) and web browser with Web Connect software (via Profi S-Link)
- ▶ Multi-protocol operation on the same Profibus network (e.g. Profi S-Bus mixed with other Profibus DP devices)
- ▶ Gateway function for gateways (Profi S-Bus ↔ Serial S-Bus, Profi S-Bus ↔ Ether S-Bus)
- ▶ Programming the exchange of data between PCD controllers with FBoxes for cyclic or event-controlled data transfer – baud rate: up to 1.5 MBit/s
- ▶ Network infrastructure and topology: in accordance with the Profibus specification

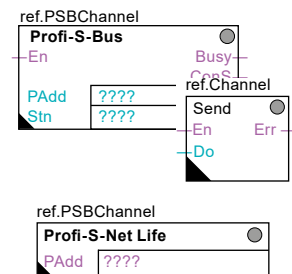

2.5.5 Profibus DP

Integrating machines and industrial environments

PROFIBUS

Profibus in building automation systems

In accordance with EN 50170, Profibus is the internationally standardised bus for industry and building automation systems. Profibus opens up the world of standardised network communication for a wide range of applications between different manufacturers:

- ▶ Profibus is open and not bound to a specific manufacturer
- ▶ PNO, the Profibus user organisation, maintains a qualified certification system and assesses Profibus products in terms of compliance with standards and interoperability
- ▶ Profibus DP, the up to 12 MBit/s network protocol for the field level in automated production is also used in building automation systems owing to the wide range of accessories

Profibus DP with Saia PCD®

Saia PCD controllers are available with Profibus DP slave connections. Version DP V0 is supported. The diverse communication properties of Saia PCD controllers makes them ideal for use as communication gateways, e.g. Ethernet Profibus, BACnet – Profibus, etc.

Saia PCD® systems with Profibus DP slave, onboard interface

Baud rate	Connection	Port	Electrically isolated	System
Up to 187.5 kBit/s	Terminal block	# 2	No	PCD3.M6880, PCD3.M6860, PCD3.M3x60, PCD1.M2xxx, PCD1.M0160E0
Up to 187.5 kBit/s	Terminal block	# 0	No	PCD2.M4160
Up to 1.5 MBit/s	D-sub connector	# 10	Yes	PCD3.M5560 PCD2.M4560, PCD2.M5540

Network configurators for Profibus

The PG5 programming tool contains convenient network configuration tools for all types of network. The user defines his variables, objects and network parameters with it.

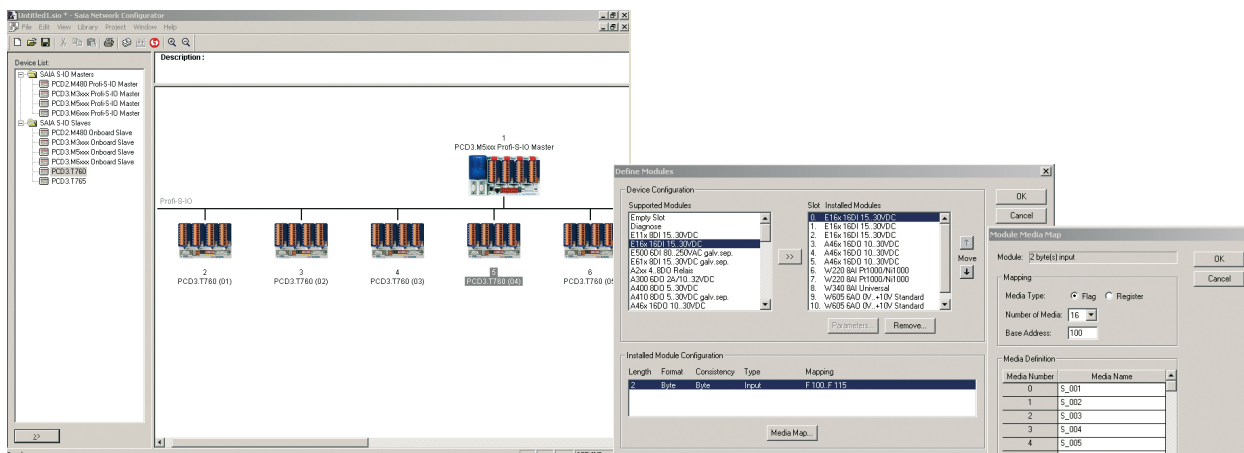

2.6 BA communication systems



2.6.1 BACnet®

The standard for building services

BACnet is a manufacturer-independent, globally standardised communication protocol which is well-established in building automation systems. BACnet is particularly suitable for heterogeneous structures involving automation stations of various manufacturers. The server/client architecture allows each of the BACnet devices to exchange data with one another without having to adjust to the parameterisation of the other devices.

BACnet is far more than a protocol for merely transferring data; BACnet itself defines important building automation functions, such as the recording of historic trends or the monitoring of values against set limit values, for example. Communication services (BIBBs, BACnet Interoperable Building Blocks), such as those for reading and writing content, event-controlled transmission following changes and the handling of alarms/information (events) are available.

PCD systems

BACnet is available for all classic PCD systems with the Saia PCD COSinus operating system as a communication option. The connection is usually direct via BACnet IP (Ethernet). BACnet MS/TP (RS-485) is also possible via a communication module.

BACnet always requires a BACnet option module for firmware expansion. A PCD7.R56x is used for memory slots M1 and M2 for PCD3.M5, PCD2.M5, PCD1.M2 and PCD1.M0 controllers. The PCD3.R562 module is available for I/O slots 0...3 for PCD3.M3 controllers with no M1/2 slots.

PCD2.M5 and PCD1.M2 controllers also require a PCD2.F2150 for connecting BACnet MS/TP, and PCD3 controllers require a PCD3.F215 communication interface. This module also provides controllers with no Ethernet with a BACnet interface. Controllers with Ethernet also take on the function of a BACnet IP MS/TP router. External gateways for connecting MS/TP devices direct to the management system or other BACnet IP devices, for example, are therefore no longer required.

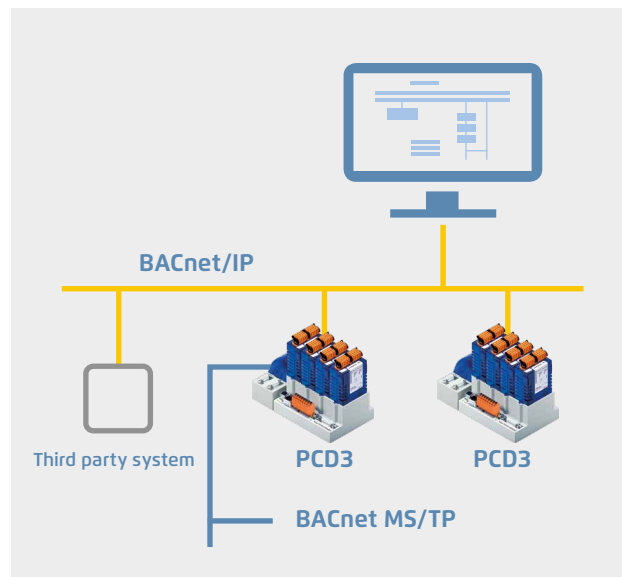

Typical applications of a BACnet infrastructure

- ▶ Heating, climate and ventilation control
- ▶ Room automation
- ▶ Networking dispersed sites
- ▶ Recording energy data



BACnet certificates for PCD1, PCD2, PCD3 controllers; see www.sbc-support.com, Certificates, PCD

Recommendations/system limits

Type	Option	Interface	PG5 configuration, system limits
PCD3.M5560/M6xx0	1× PCD7.R562 4× PCD3.F215	IP MS/TP	Recommended for configurations of up to 1000 BACnet objects
PCD3.M5360	1× PCD7.R562 4× PCD3.F215	IP MS/TP	Recommended for configurations of up to 800 BACnet objects
PCD3.M3160 PCD3.M3360	1× PCD3.R562 3× PCD3.F215	IP MS/TP	Recommended for configurations of up to 500 BACnet objects
PCD2.M4160	1× PCD7.R562 2× PCD2.F2150	IP MS/TP	Recommended for configurations of up to 800 BACnet objects
PCD2.M4560 PCD2.M5540	1× PCD7.R562 4× PCD2.F2150	IP MS/TP	Recommended for configurations of up to 800 BACnet objects
PCD1.M0160E0	1× PCD7.R562	IP	Recommended for configurations of up to 800 BACnet objects
PCD1.M2xx0 PCD1.M2220-C15	1× PCD7.R562 2× PCD2.F2150	IP MS/TP	Recommended for configurations of up to 800 BACnet objects
PCD7.D410VT5F PCD7.D412DT5F	1× PCD7.R562	IP	Recommended for configurations of up to 250 BACnet objects

BACnet®

Efficient engineering through automatic generation

The application FBox libraries from DDC Suite v2.0 and Room Controller v2.0 and above make the system integrator even more efficient. An FBox parameter can be used to automatically generate a suitable BACnet® configuration when creating the application program. All the relevant settings are implemented within the application FBoxes.

Fully programmable BACnet configuration

The application can be created as normal using the Saia PG5® Controls Suite.

The BACnet® configurator it contains allows the completely free parameterisation of all BACnet® objects. This makes it possible to solve all conceivable tasks.

Clearly structured dialogues make the parameterisation of schedules, trends and alarms easy to understand.

PG5 Fupla Editor

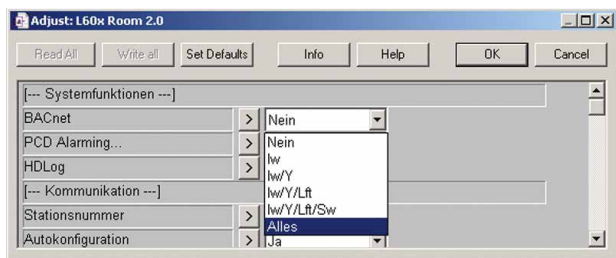
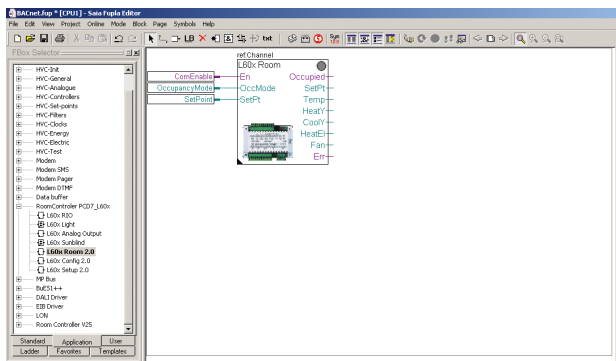

BACnet® Adjust Window

BACnet® configurator in the Saia PG5® Controls Suite

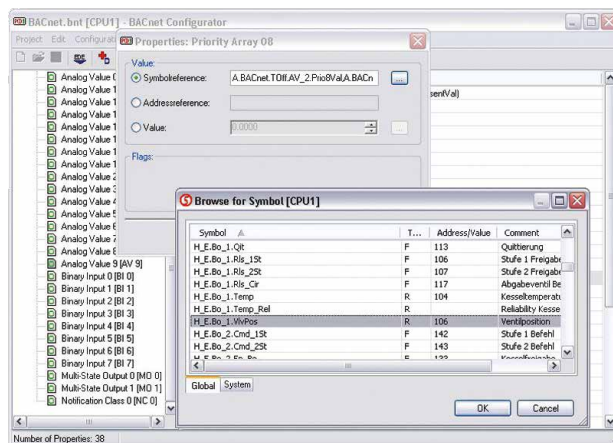

Automatic creation of BACnet® objects and PCD resources using FBoxes and templates.

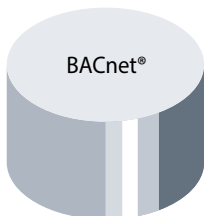

EDE file export for connecting the PCD to master SCADA systems.

EDE file import for the simple creation of BACnet® clients

Order details

Type	Description
PCD7.R562	BACnet® optional module for PCD1.M0, PCD1.M2, PCD2.M5, PCD3.M5 and PCD3.M6 for M1 or M2 slots incl. 128 MB for program backup and file system
PCD3.R562	BACnet® optional module for PCD3.M3, PCD3.M5 and PCD3.M6 for I/O slot 0...3 incl. 128 MB for program backup and file system



2.6.2 Modbus

Modbus

Modbus is a communication protocol based on a master/slave or client/server architecture. It is widespread and supported by many manufacturers and devices. In many cases, Modbus is therefore the common denominator for transferring data between different devices and systems.

Modbus with Saia PCD®

Modbus comes in three forms:

- ▶ **Modbus ASCII** data are transmitted in ASCII format via serial interfaces (RS-232, RS-485).
- ▶ **Modbus RTU** data are transmitted in binary format via serial interfaces (RS-232, RS-485).
- ▶ **Modbus TCP** data are transferred in TCP/IP or UDP/IP packets via Ethernet.

The Modbus protocol is supported in the Saia PCD COSinus operating system by all Saia PCD1.M0_, Saia PCD1.M2_, Saia PCD2.M5_ and Saia PCD3 controllers. Client and server functionalities are available for all types of protocol. Ethernet interfaces and serial interfaces (RS-232 and/or RS-485) are already included in the PCD controller basic devices. Additional plug-in interface modules can be used to operate up to 9 serial Modbus interfaces per PCD system.

Supported Modbus function codes

- 1 Read Coils
- 2 Read Discrete Inputs
- 3 Read Holding Registers
- 4 Read Input Registers
- 5 Write Single Coil
- 6 Write Multiple Coils
- 7 Write Single Holding Register
- 8 Write Multiple Holding Registers

Media Mapping: adjustable by the user
 Mapping Areas: max. 10 per UID
 Number of servers: max. 4 per PCD system
 Number of unit IDs: max. 10 per PCD system
 Number of channels: max. 10 per PCD system

Number of connections

Each Saia PCD system is able to establish up to a maximum of 26 connections. Of these, the Saia PCD controller is able to use a maximum of 10 for client connections. The remaining connections can be used as server connections to the same Saia PCD controller.

Application example

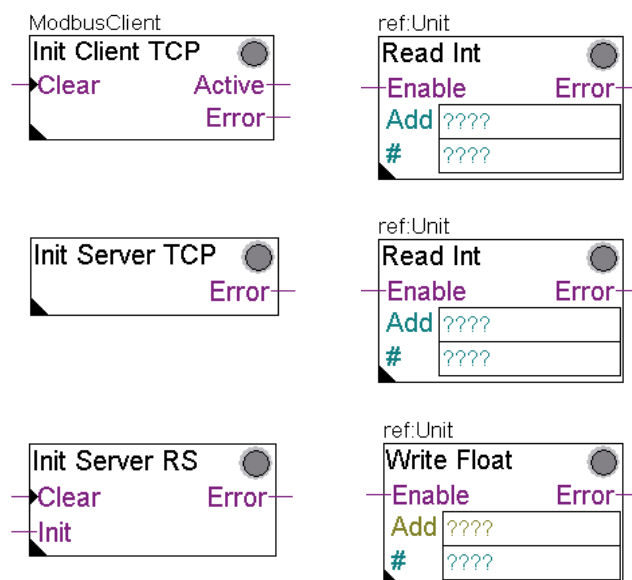
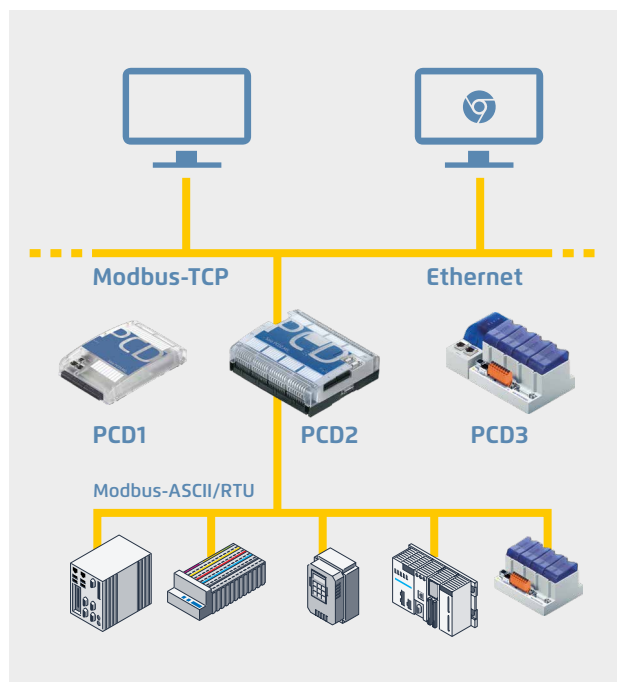

▲ Convenient Fulpa FBoxes or CSF commands are available for configuring and programming the exchange of data.

◀ With the integrated automation server, external systems can also be easily linked to master Web+IT automation environments via Modbus.

2.6.3 KNX

Communication drivers for electrical systems and room automation

Communication drivers

An efficient networking of building services requires multi-service functions and components for communicating with external devices. The KNX communication driver is a PG5 FUPLA library with comprehensive function modules (FBoxes) for sending and receiving almost all KNX data types (DPT). Depending on which interface is available for accessing the KNX network (RS-232 or Ethernet), the selected components can be linked to Saia PCD systems.

The direct connection via Ethernet makes access to KNX data even quicker and more powerful.

Features

- ▶ Use of drivers for all SBC automation stations
- ▶ Simple communication connection with FUPLA modules
- ▶ Comprehensive support of KNX Data Point Types (DPT)
- ▶ The drivers support the simple restructuring of existing systems with KNX BCU1 on the KNX BCU2 interface
- ▶ Standard UDP/IP port: #3671
- ▶ Communication drivers for:
 - ▶ Serial KNX BCU-1 interfaces via RS-232 (not recommended for new products)
 - ▶ Serial KNX BCU-2 interfaces via RS-232
 - ▶ KNXnet/IP (EIBnet/IP) communication

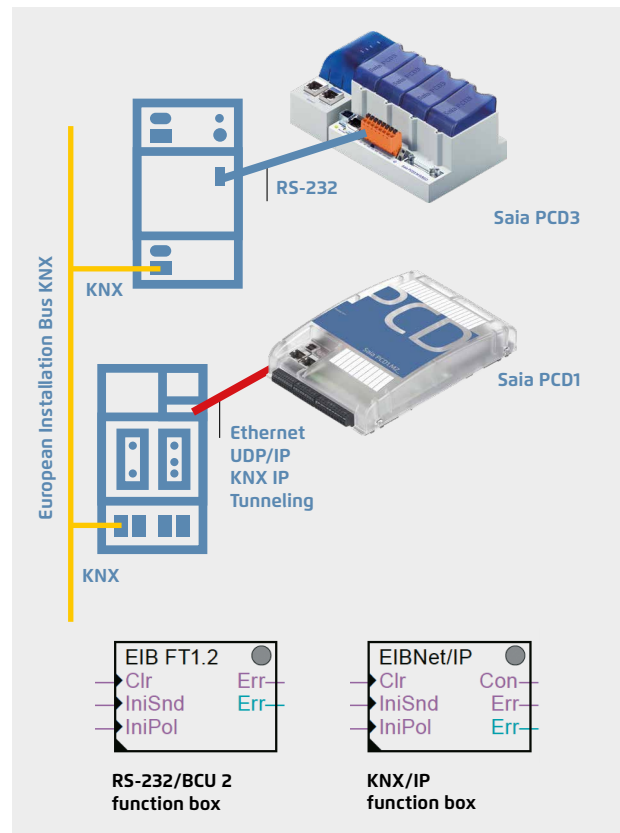

Order details

Type	Description
PG5 EIB	PG5 KNX/EIB (KNX standard) communication library for Saia PCD® controllers for serial and IP-based communication

Components of other providers

Weinzierl KNX IP Interface 730 (www.weinzierl.de)	KNXnet/IP Gateway
Weinzierl KNX IP Router 750 (www.weinzierl.de)	KNXnet/IP incl. router use
ABB IPS/S2.1 EIB/KNX IP Interface (www.abb.com)	KNXnet/IP Gateway
ABB IPR/S2.1 EIB/KNX IP Router (www.abb.com)	KNXnet/IP incl. router use
Weinzierl KNX BAOS 870 (www.weinzierl.de)	Serial (RS-232) KNX interface with BCU-2 protocol



Ethernet Gateways

When planning, it is important to bear in mind that some Ethernet gateways only support one communication channel. Every PCD or service tool, ETS for example, therefore requires its own interface to the KNX Bus.

Serial converter

However, it is inadvisable to connect using BCU-1 protocols. The BCU-1 protocol can cause telegrams to be lost between the gateway and the controller.

2.6.4 EnOcean

Communication driver for wireless sensors and actuators



EnOcean is the inventor and manufacturer of the patented basic “self-powered wireless sensor technology”. EnOcean was recognised as the first ISO/IEC wireless standard (ISO/IEC 14543-3-10) for optimised solutions with low energy consumption. The “EnOcean alliance” is a manufacturers’ interest group which, over time, has developed a wide range of self-powered components for building automation systems based on EnOcean technology, such as switches, sensors, actuators and gateways.

Communication drivers

The EnOcean components are connected to the Saia PCD controllers via external wireless gateways via serial RS-485 or IP interfaces. The FBox library provides communication modules for transmitting and receiving EnOcean telegrams. Generic FBoxes are available for standard EnOcean devices. Device-specific FBoxes are available for a selection of manufacturer-specific devices such as room control units (PEHA Sensortec, Thermokon, etc.). Universal communication FBoxes also offer the option of processing any EnOcean telegram in the PLC program.

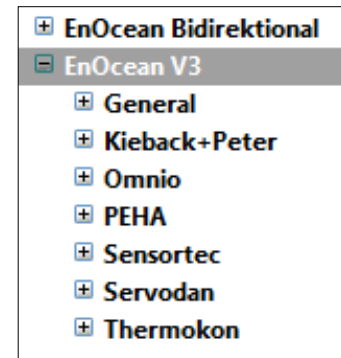

Connection diagram for the RS-485 wireless receiver

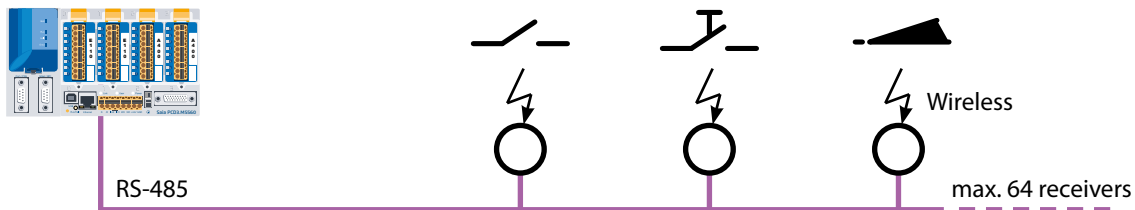

The number of transmitters per receiver is limited only by the distance and the reception quality.

Order details

Type	Description
PG5 – EnOcean V3	PG5 – EnOcean communication library for Saia PCD® controllers for serial (EVC mode) and IP-based communication.

Components from PEHA recommended (www.peha.de)

D450ANT	EnOcean wireless receiver with RS-485 interface (bidirectional), IP 20 casing with internal aerial
---------	--

Other EnOcean components such as switches, hotel card switches, window contacts, radiator actuators... are recommended by PEHA.

Components from Thermokon (www.thermokon.ch)

SRC65-RS-485E	EnOcean wireless receiver with RS-485 interface (unidirectional), IP65 casing with external antenna
STC65-RS-485E	EnOcean wireless receiver/transmitter with RS-485 interface (bidirectional), IP65 casing with external antenna

Sensortec components (www.sensortec.ch)

EOR700EVC	EnOcean wireless receiver with RS-485 interface (unidirectional), IP20 casing with internal antenna
EOR710EVC	EnOcean wireless receiver/transmitter with RS-485 interface (bidirectional), IP 20 casing with internal antenna



The number of required wireless gateways depends heavily on the structural conditions. Pillars and furniture can create “dead spots” and walls can dampen the wireless signal depending on their design. Additional information and a brief planning guide are contained in the EnOcean manual (see www.sbc-support.com) EnOcean V3 is the latest version. The FBox library "EnOcean bidirectional" is only to be used for existing projects.

2.6.5 M-Bus

field bus module for capturing consumption data



M-Bus master interface module

M-Bus (EN 1434-3) is an international standard for remote meter reading. The M-Bus connection is formed using the PCD2.F27x0 / PCD3.F27x communication modules in slots 0...1 on the PCD1.M2* and 0...3 on the PCD2.M5 and PCD3. This enables all volumes of water, heat or energy to be captured in an automation station. The measurement data is subsequently processed in an FBox library in the Saia PCD FUPLA.

The interface modules are fitted with a power supply and two separate M-Bus interfaces. Depending on the design, the integrated power supply is sufficient for up to 120 M-Bus standard slave modules whereby it can be distributed as required across the two ports.

The PCD2.F2710...F2720 and PCD3.F271...F272 master modules require the Engiby M-Bus library.

FBoxes for SBC energy meters with M-Bus are supported by the Engiby library.

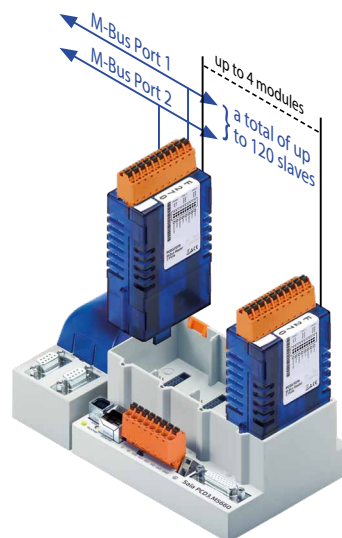

M-Bus via serial interface

In PCD controllers, M-Bus is connected with no slot for M-Bus master modules via an external signal converter. RS-232 or RS-485 interfaces are used depending on the converter.

Driver settings

The respective PCD communication interface is specified in the M-Bus driver FBox in the Engiby library.

Note the converter interface parameters such as baud rate, timeout, etc.

Secondary addressing

Secondary addressing is supported from Library Version 2.7.200 or higher for SBC energy meters and generic FBoxes. Primary addressing must be used for the product-specific FBoxes.

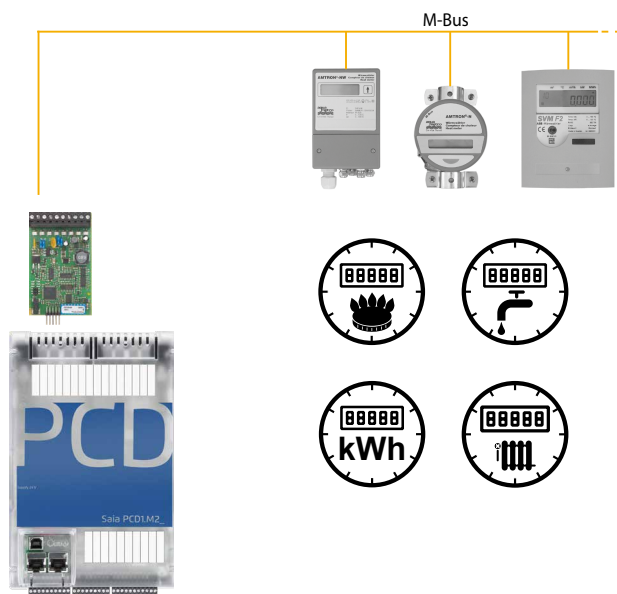

Application example: PCD1.M2120 with M-Bus activation.

* PCD1.M2110R1 slot 0 only

PCD1/PCD2 ordering information

Type	Description	Weight
PCD2.F2700	M-Bus master interface for up to 240 slaves	60 g
PCD2.F2710	M-Bus master interface for up to 20 slaves	60 g
PCD2.F2720	M-Bus master interface for up to 60 slaves	60 g



PCD2.F27x0

PCD3 ordering information

Type	Description	Weight
PCD3.F270	M-Bus master interface for up to 240 slaves	80 g
PCD3.F271	M-Bus master interface for up to 20 slaves	80 g
PCD3.F272	M-Bus master interface for up to 60 slaves	80 g



PCD3.F27x

Driver licence free

M-Bus Drivers

- M-BUS Master
- M-BUS Master Reset

Saia Energy Meters licence free

M-Bus Electricity Saia PCD

- Saia PCD ALE
- Saia PCD ALE/AWD Extended
- Saia PCD AWD

Engiby M-Bus Library, licence required

M-Bus Electricity

- M-Bus General
- M-Bus Heating
- M-Bus Water/Volume

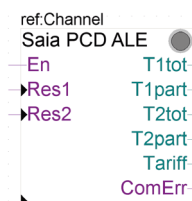

2.6.6 DALI

field bus module for lighting systems



DALI master interface module

DALI is a communication system for lighting control, standardised in accordance with IEC 62386-101/102. Installation is easy. The DALI Bus simply needs 2 unshielded wires which can be threaded through the same cable along with the power supply, generally 230 V.

The light parameters are standardised. All upstream devices therefore have the same parameters for dimming, grouping and scenes, irrespective of the type of lighting.

The DALI master module includes the Bus power supply for up to 64 DALI participants. The extensive PG5 FBox library has function modules for commissioning, operating and servicing with the PLC program. External software tools or other components are not required.

Smaller DALI controls can be implemented with the PCD1.F2611-C15 E-Line DALI module. Detailed information about this small controller can be found in the E-Line chapter.

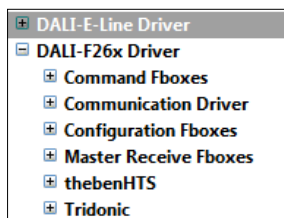
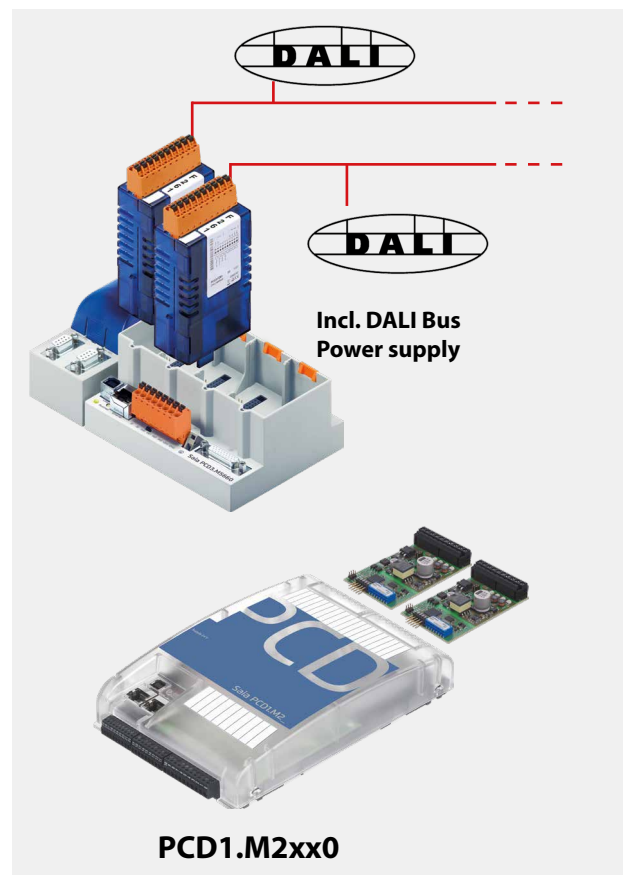

PG5 – DALI F26x FBox library



PCD3.F261



PCD2.F2610



PCD1.F2611-C15

Order details

Type	Description	Application note	Weight
PG5 – DALI F26x	PG5 – DALI communication library for connecting DALI lighting control systems	–	–
PCD3.F261	DALI master interface for up to 64 DALI participants incl. bus power supply (200 mA/12... 13.5 V)	PCD3.Mxxx0: I/O slot 0-3 PCD3.T666: I/O slot 0-3	80 g
PCD2.F2610	DALI master interface for up to 64 DALI participants incl. bus power supply (200 mA/12... 13.5 V)	PCD1.M2110R1: I/O slot 0 PCD1.M2xx0: I/O slot 0-1 PCD2.M4160: I/O slot 0-1 PCD2.M4560: I/O slot 0-3 PCD2.M5xx0: I/O slot 0-3	60 g
PCD1.F2611-C15	DALI master interface for up to 64 DALI participants incl. bus power supply (160 mA/13... 15.5 V)	–	130 g



Please observe the information for the PCD firmware version and the PG5 version on the support page.

DALI communication library

Commissioning and servicing made easy

When initialising, the "DALI F26x Driver" FBox is positioned once only when the program starts. The "Configuration Manager" FBox then parameterises all the DALI participants on the bus. The FBox also provides predefined symbols for further use, e.g. in S-Web. The parameters can also be used securely in the PCD file system. The "Backup to Flash" FBox stores all DALI parameters in parallel in two files. This guarantees the retention of data in PCD systems with no batteries, e.g. in the Smart RIO PCD3.T666, required.

When commissioning DALI systems, it is usual to install all DALI participants then issue the addresses and set the parameters via the DALI commissioning software. The "Random addressing" and "Exchange addresses" modules are in the Saia PG5® – DALI library.

Parameterisation takes place after the addressing process using the "Configuration manager" FBox. Group and scene parameters can alternatively be set using the "Edit Groups" and "Edit Scene Levels" FBoxes to provide a better overview.



Operation

The "Send Command Inputs", "Send Command Online", "Send Power Control" and "Send Scene" FBoxes are available for transmitting DALI commands. These FBoxes cover all standard DALI commands.

The receipt of master telegrams is also supported by the "Receive Commands" and "Receive Raw" FBoxes. "Receive Raw" is useful for receiving non-standard telegrams. The raw data can then be processed further in the application program.

The lamp status can be requested using the "Read Status" FBox. The "Query numeric" FBox provides the application program with access to a further 21 DALI standard data points such as the current light level.

The "Read Memory" FBox is used to read any data from a DALI device. It is therefore possible to request brightness and presence information from one sensor, which would not be accessible with the DALI standard methods.

DALI controller with PCD1.F2611-C15:

There are also different FBoxes within the "DALI E-Line Driver" rubric for commissioning and operation for this interface.

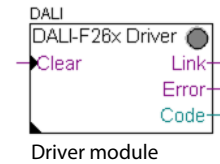

Driver module

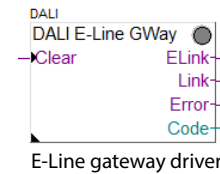

E-Line gateway driver

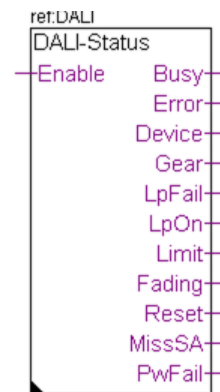

Status monitoring

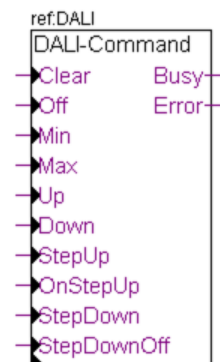

Lighting control on/off, dimmable

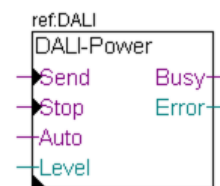

Direct lighting control

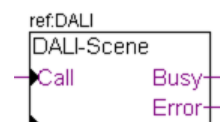

Scene controller



The current DALI standard does not guarantee a genuine multi-master function. Multi-master capable products such as those of Tridonic, Osram or Zumtobel are either based on the new draft DALI extension E DIN 62386-103 (2011-08) or accept the loss of telegrams in bus collisions. Permanent polling, e.g. of the status, should therefore be avoided in "multi-master" projects. The maximum number of DALI master devices can be restricted to 8 units, for example, depending on the product and hardware manufacturer.

2.6.7 MP Bus

field bus module for Belimo MP Bus devices



MP Bus master interface module

MP Bus is a Belimo communication system used to connect Belimo MP* field devices such as valve and shutter position drives or VAV controllers and room air sensors in building automation systems. Installation is easy. In addition to the 24 V AC/DC power supply, the MP Bus needs just one unshielded wire which can be run through the same cable.

Up to 8 drives can be attached to one communication channel. The total length of the mains cable depends on the diameter of the selected cable and the number and output of the connected drives**. A total length of approx. 100 m is usually reached. Since the length of the connection and the number of drives is limited, no other demands such as termination resistors or shielded cable are placed on the bus topology. In addition to the connected drives, sensors can be connected direct via a drive or MP Bus add-on modules. The extensive Saia PG5® FBox library has function modules for communicating with the PLC program. The drives are addressed using the communication driver FBox and can then exchange data with the application program via the respective FBoxes. The Belimo components are generally commissioned from the application program using the SBC FBoxes. Only a few components such as VAV controllers require additional Belimo parameterisation tools to adjust their operational parameters.

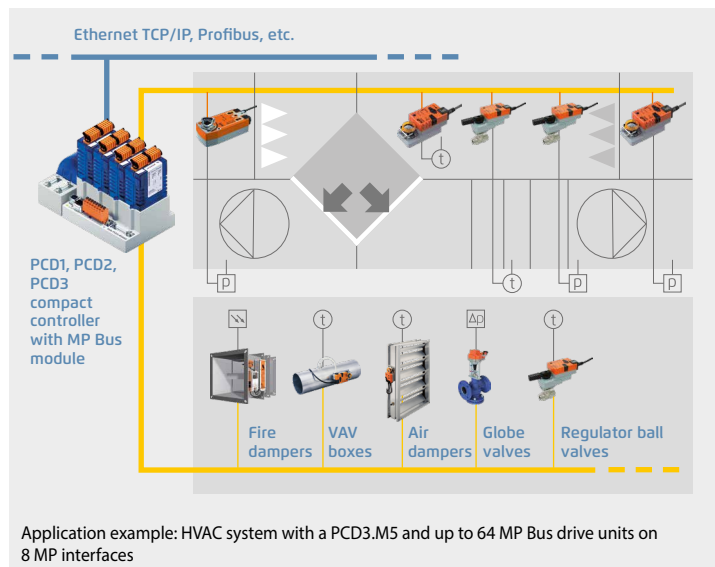

* MP is a Belimo designation. MP = multi-point

** For further information on the system layout, see the Belimo documentation, www.belimo.com

Overview

Automation station	Onboard; Slot A, A1 and A2				I/O slot #0...#3			
	MP Bus module	Total	Number of MP Bus		MP Bus module	Total	Number of MP Bus	
			Cables	Drives			Cables	Drives
PCD3.M3x60 / PCD3.M5x60 / PCD3.M6x60	-	-	-	-	PCD3.F21x, PCD3.F221	4	-	-
					+ PCD7.F180S	+ 4	+ 32	
PCD2.M5540 / PCD2.M4560	PCD7.F180S	2	2	16	PCD2.F21x0, PCD2.F2210	4	-	-
					+ PCD7.F180S	+ 4	+ 32	
PCD1.M2x20 / PCD1.M2x60 / PCD1.M2220-C15 / PCD2.M4160	PCD7.F180S	1	1	8	PCD2.F21x0, PCD2.F2210	4	4	32
					+ PCD7.F180S*	+ 2	+ 16	
PCD1.M2110R1 - Room	PCD7.F180S	1	1	8	PCD2.F21x0, PCD2.F2210	2	-	-
					+ PCD7.F180S	+ 2	+ 16	
PCD1.M0160E0	PCD7.F180S	1	1	8	PCD2.F21x0, PCD2.F2210	2	2	16
					+ PCD7.F180S	+ 2	+ 16	
PCD1.M2110R1 - Room	PCD7.F180S	1	1	8	PCD2.F21x0, PCD2.F2210	1	-	-
					+ PCD7.F180S	+ 1	+ 8	
PCD1.M0160E0	PCD7.F180S	1	1	8	PCD2.F2810	1	1	8
					+ PCD7.F180S	+ 1	+ 8	
PCD1.M0160E0	PCD7.F180S	1	1	8	-	-	-	-

* With 4 PCD3.F281 only 2 additional PCD7.F180S can be used, because the load on +V would be too large

MP Bus | Function modules (FBox)

All Belimo MP drives can exchange data with the PCD application program via a suitable FBox from the MP Bus FBox library. The master communication FBox must be positioned once at the start of the application program. It controls the communication and fault recognition and creates ways of addressing the MP drives available for commissioning and service. Some MP drives also have an input for connecting sensors. R: Temperature sensor NI1000, PT1000..., U:voltage 0–32 V or 0–10 V and DI: Potential-free contact.

Type/performance categories	Sensors	MP Bus FBox
Communication drivers		MP Single
Ventilation applications Damper drives with no safety function: LM24A-MP (5 Nm), NM24A-MP (10 Nm), SM24A-MP (20 Nm), GM24A-MP (40 Nm) Damper drives with safety function: TF24-MFT (2 Nm), LF24-MFT2 (4 Nm), SF24A-MP (20 Nm) Linear damper drives: LH24A-MP100 / 200 / 300 (150 N), SH24A-MP100 / 200 / 300 (450 N) Damper drives rotary: LU24A-MP (3 Nm)	R, U, DI	MP Air
Safety applications Drives for fire dampers: BF24TL-T-ST (18 Nm), BFG24TL-T-ST (11 Nm) Gateway for conventional fire damper drives: BKN230-24-C-MP	Thermo- element	MP BS
Room and system applications VAV compact controller: LMV-D3-MP (5 Nm), NMV-D3-MP (10 Nm), SMV-D3-MP (20 Nm) VAV compact controller linear: LHV-D3-MP (150 N) VAV universal controller: VRP-M	R, U, DI	MP VAV... VRP-M
Water applications Lift drives with no emergency function: LV24A-MP-TPC (500 N), LVC24A-MP-TPC (500 N), NV24A-MP-TPC (1000 N), NVC24A-MP-TPC (1000 N), SV24A-MP-TPC (1500 N), SVC24A-MP-TPC (1500 N), EV24A-MP-TPC (2500 N) Lift drives with emergency function: NVK24A-MP-TPC (1000 N), NVKC24A-MP-TPC (1000 N), AVK24A-MP-TPC (2000 N), adjustable closing point, adjustable emergency setting	R, U, DI	MP Linear
Drives for control ball valve with no emergency function: LR24A-MP (5 Nm), NR24A-MP (10 Nm), SR24A-MP (20 Nm) Drives for control ball valve with emergency function: TRF24-MFT* (2 Nm), LRF24-MP (4 Nm), NRF24A-MP (10 Nm) Drives for butterfly valves with no emergency function: SR24A-MP-5 (20 Nm), GR24A-MP-5/-7 (40 Nm)	R, U, DI	MP Air
Drives for 6-way control ball valve: LR24A-MP (5 Nm), NR24A-MP (10 Nm)	R, U, DI	MP 6 Way
Electronic pressure-independent control ball valve (EPIV): P6...W...E-MP*, EP0..R+MP*	U, DI	MP EPIV...
Belimo EnergyValve: EV..R+BAC, P6..W..EV-BAC	U, DI	Energy Valve P6
Rotary actuator: CQ24A-MPL (MP-Bus light)	—	MP MPL
Room sensors Room combi-sensor, depending on design with temperature, CO₂, VOC and relative humidity: MS24A R... MPX	R, DL, U (0–10 V)	MP THC24 MP THCV
Generic data transfer For reading and transmitting data points not contained in the device-specific FBox. This FBox is used as a functional extension for MP Bus FBoxes and can only be used with a device FBox specific to that device or a generic device FBox.		MP Generic MP PEEK MP POKE
Third party devices FBoxes are available for the following third party MP Bus devices: PTH sensor from wmag AG, Switzerland, UST-3, UST-5 from wmag AG, Switzerland. Each MP Bus device can also be connected via generic devices and peek/poke FBoxes in PCD application programs.		MP PTH MP UST-3 MP Generic MP PEEK MP POKE

* only active sensors and switches can be connected

2.6.8 Other drivers

Communication drivers from www.engiby.ch

Field bus, standard/universal interfaces

Modbus	The Modbus protocols allows the exchange of data with a wide range of industrial devices and many supervisors. The Modbus 2 library supports the following Modbus protocols: <ul style="list-style-type: none"> • ASCII + RTU over serial lines RS-232, 422 and 485 • TCP + UDP over Ethernet
M-Bus	With the M-Bus FBox driver library, the Saia PCD® acts as Master and is able to read the values from the meters, using either a PCD2/3.F27x module, or a M-Bus level converter.
DLMS	M-Bus library extension for DLMS protocol.
MQTT	Lightweight, publish-subscribe network protocol that transports messages between two devices over TCP/IP.
NG-Alarm	Allows the sending of SMS over Internet (TCP/IP, HTTP port).
3964(R) / RK512	The 3964(R) Driver allows data exchange with Siemens systems. It will allow direct access to the Saia PCD® media.
S-Bus with NG-Configurator (TCP/IP)	S-Bus driver for multi-master applications, for efficient configuration in MS Excel tables.
S-Bus with NG-Configurator (serial)	S-Bus driver for quick response time with priority, for efficient configuration in MS Excel tables.
KNX with NG-Configurator	KNX Configurator library for definition of KNX data points.
IEC 60870-5-101	Power plant/energy management.
IEC 60870-5-103	Switching station controller.
IEC 60870-5-104	Power plant/energy management.
ESPA 4.4.4	Send and receive Messages, forward and route Messages via SMS, pager or TAP.
Text Output	Configuration tool for transmitting formatted texts event triggered via serial interfaces, TCP/IP or UDP/IP. Also supports SMS.
Text Parser	Configuration tool for reading and analyzing PCD text input.
SNMP Traps	Alarm messages (Trap) to network Management Systems (NMS), Syslog messages and device-list to PING.

Controller/energy

ExControl	Light and shade functions with remote access via RS-232 or Ethernet.
APC Data Guard	Carel controllers with APC Data Guard protocol.
TRSI	WITnet concept, remote control. The Saia PCD® acts as master of the communication and the program is realized with FBoxes for Fupla.
COMSAB / York	SABROE compressor control units: – PROSAB II, UNISAB S / R / RT / RTH, UNISAB II The Saia PCD® is Master and supports Read and Write access to all variables.
Johnson N2	The Johnson N2 Driver allows data exchange with Johnson controllers of the TC-9100 and DX-9100 families.
Luxmate	Communication with lightning control BMS ZUMTOBEL.

Alarm / messages / access

NG-Alarm	Allows the sending of SMS over Internet. (TCP/IP, HTTP port).
Commend	Interphone system.
Fidelio / FIAS	Hotel management system.
Cerberus	Siemens-Cerberus alarm systems.
Tyco MX	Tyco MX 1000 and 4000 fire alarm system.
Securiton / SecuriPro	Fire and intrusion Alarm systems.
TechTalk	Access control system.

Pumps/Clock/Others

Wilo / EMB	The Wilo Driver allows communication over serial RS-485 line with pumps from Wilo (Germany) and EMB (Switzerland). The driver is available in form of an FBox family for Fupla.
Grundfos	The Grundfos Driver for the GENibus protocol allows you to control Grundfos pumps over an RS-485 serial line.
ebmBUS	The ebmBUS Driver supports communication over serial RS-485 lines with ebm-Papst motors. The driver is available in form of an FBox family for Fupla.
Clock	Reception of time data for DCF77 and GPS.
Marksman	Road traffic counter.

Saia Burgess Controls communication drivers

P-Bus	Communication driver to Siemens P-Bus I/O level.
N2-Bus	Communication driver to JCI-N2 bus for connecting JCI master or slave systems.

For German-speaking customers: Communication drivers from Kindler Gebäudeautomation GmbH, www.kga.de

Danfoss KGA.Danfoss	FBox library for communicating with VLT 6000 / FC100 Danfoss® frequency inverters with the standard FC communication protocol.
------------------------	--

SBC S-Web technology

Automation systems with sophisticated SCADA functions “embedded” in every device.

- Alarming
- Trending
- Visualisation
- Standard web browser as service interface software



3.1 The aim of S-Web: To use what you know and what already exists

Page 218

No need to continue using proprietary SCADA/management PC software. Each interest group gets exactly what it needs and no extraneous elements will confuse the user. Current end devices and existing technology used on site will be sufficient.

3.2 The S-Web system architecture: SCADA in every automation device

219

The functional basic structure of a single automation device is used to illustrate how SBC S-Web systems are designed for machines, plants and distributed properties.

3.3 Real-life examples of SBC S-Web

221

Four projects illustrate how thousands of S-Web systems have been implemented in the field. They explain how the systems progress from design to implementation and operation.

3.4 Engineering Information

223

What should you bear in mind when implementing and integrating SBC S-Web systems?
How do they differ from conventional PC-based SCADA/HMI solutions?

3.5 Tender information – what changes with S-Web

227

The typical tender for automation/ICA systems still involves the current strict separation of control engineering and process control and management functions on separate levels. SBC S-Web combines different functions in a single device. This can also be seen in the tenders.

3.6 SBC S-Web system tools and products

231

What is available from SBC? How are system components of other manufacturers incorporated?
What software tools are available for creating projects?

3.7 Using Automation Server as a technical basis

235

Automation Server functions in every SBC device are the technical requirements for SBC S-Web systems. What sort of functions are they? What benefits do they provide?

3.1 The objective of S-Web

using the known and existing components. Use fewer unknown and complex elements.

As a company, we focus on being as lean as possible. The aim of being lean is to achieve ever more using less. That is only possible by exploiting what you already have. As little as possible should be added to this. SBC S-Web is dedicated to this principle.

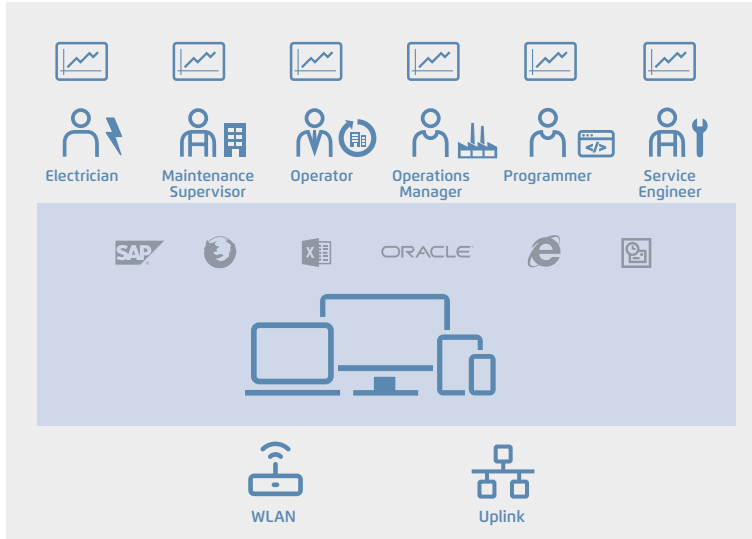

SBC S-Web optimises use of

- ▶ Existing software
- ▶ Existing human resources
- ▶ Existing infrastructure and end devices

SBC S-Web systems

- ▶ Make special SCADA software unnecessary
- ▶ Reduce the need for trained personnel in the operation
- ▶ Make an investment project simpler and more cost-effective

◀ It is worth exploiting what already exists on-site.



Software: Management functions can be performed using dedicated software. This has to be purchased, installed, configured, maintained and personnel must receive training. It can usually perform far more functions than it is actually used for, and is therefore complex. SBC S-Web makes this dedicated management/SCADA software unnecessary. It simply uses the software which is already available everywhere.



Human resources: Monitoring, control and management functions are possible for all interest groups/individuals. Users can optimise their area of responsibility in a way that is tailored to their requirements. No users have to be an automation specialist, no specific tools are required, and there is no waiting time to carry out analysis or improvements.



Infrastructure and end devices: SBC S-Web can be integrated simply and safely into existing LAN/WAN infrastructures. Practically all the existing end devices can be used. This increases acceptance and reduces costs. This is because each control unit has sophisticated SCADA functions via many globally recognised technical standards.

Using what already exists?

- ▶ Use as few new, unknown and complex elements as possible



In order to implement SCADA/management/operating functions using SBC S-Web, only technologies that are used and already exist have been implemented on site. They are globally recognised, non-proprietary Web+IT standards. The required functions can be flexibly adapted over the entire service life of a system and kept simple to master. This is possible because the basic characteristics of the classic PLC technology are also integrated into the S-Web systems. A unique combination!

3.2 S-Web system structure

SCADA function in every automation device

The conventional regulation/control unit of automation only regulates and controls. The third essential core component, the SCADA function, is outsourced and implemented "elsewhere". This was a practical solution 2008 ago, as memory and processor power were expensive and limited. Since then, costs have reduced in terms of both memory and performance. All the functions required for the automated system can now be implemented in one device as a single project.

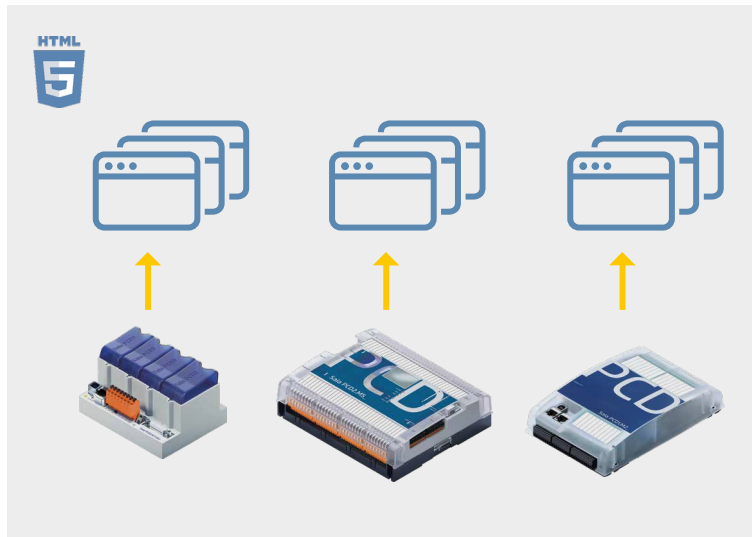

▲ **Functional structure of Saia PCD® control units:** The entire automation application is onboard. The combination of globally standardised, non-proprietary Web+IT functions known as Automation Servers form the interface to the environment. The fully programmable design and modular expansion of the controller ensure the "perfect fit" for current task formulation over a service life of 15-20 years with no need for new investment.

To the benefit of the users and operators of plants / properties

► Technological advancement creates massive structural changes in the automation pyramid

Previously only PCs had the necessary resources for management/control functions. The SCADA/management software was loaded onto them. The automation/field levels were closely linked using bus systems. This is now outdated.

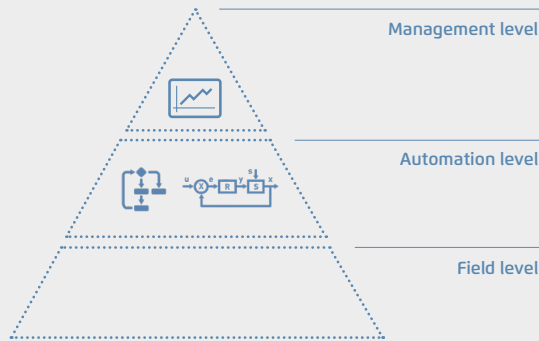

Today with SBC S-Web: Each unit has its own fully integrated automation function. Even simple field installations now have their own SCADA function which guarantees local optimisation and reliable operation. There are short paths and direct influence on processes. Control/management functions need not be laborious and expensive through the data transfer running through the automation level to the management level and back.

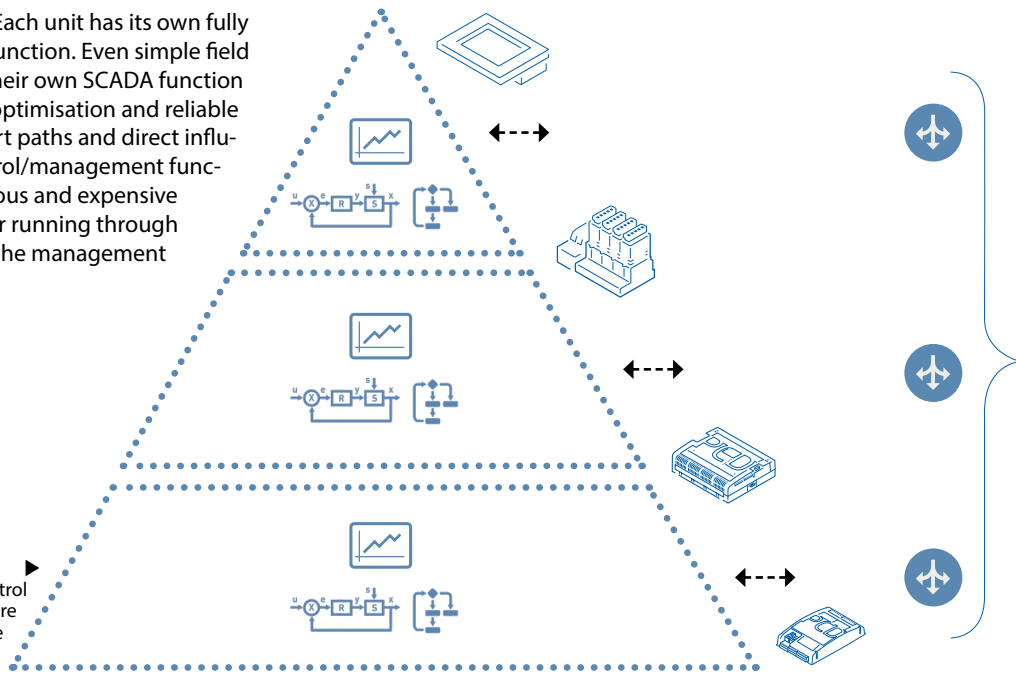

Saia PCD devices can be fully programmed and expanded with Saia PG5 across all levels and throughout the entire service life.

All automation functions (control and management functions) are integrated into every device

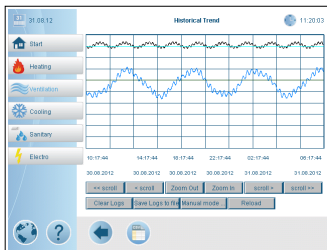

▲ SBC S-Web Trending

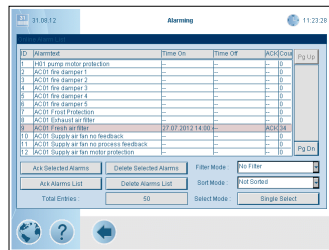

▲ SBC S-Web Alarming

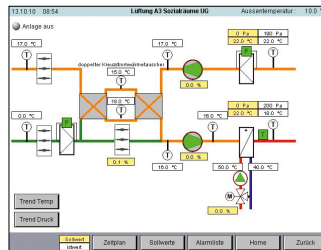

▲ SBC S-Web System Visualisation



▲ SBC S-Web Service Interface



BACnet has a comparable system model: BACnet is the only globally recognised and widely spread standard for building automation systems. It is based on exactly the same system model as Saia PCD units. However, SBC S-Web implements the management/control function in buildings with the combination of the known = PLC+Web+IT; without introducing another standard to the building.



3.3 Real-life examples of SBC S-Web

Marc Cain Building

Bodelhausen/Germany

POM-certified (peace of mind) HVAC system and room control technology for the head office of this international fashion company provides a better climate and low energy consumption.



The performance requirements for the automation of the building were set at a high level right from the beginning to achieve "peace of mind" certification from the German standards authority, TÜV. Using this approach, the design study integrated all the HVAC aspects of the building into a single, flexible control project. The thermal energy, for example, is produced by various sources and its distribution is controlled to minimise energy consumption. In a complex installation, this is only possible because the control system can seamlessly integrate all devices independent of their communication capabilities.

The Marc Cain system comprises 25 automation devices. 24 Saia PCD3.M5x40 cover the individual system components/sub-sections. One Saia PCD3.M5x60 forms a master control/management level for the entire property. Any browser device in the network (LAN/WAN) can now be used to access the local operator application of each individual system or even directly access the control/management application of the master Saia PCD3.M5x60. Complex system schematics naturally require adequate display sizes; a PDA/mobile phone is not large enough for this.

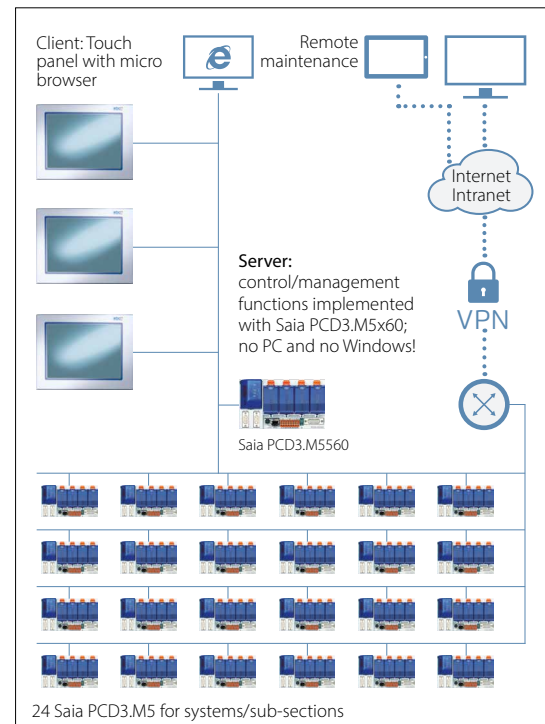

Lucerne Conference Centre Lucerne/Switzerland

The renovation and expansion of the Lucerne Conference Centre achieved the Minergie Standard and revitalised this important meeting place.



The 13,000 m² of the four halls of the Lucerne Conference Centre provide the most modern technological exhibition area, in order to be able to meet all usage requirements. The range of different events also require a flexible architecture for lighting, ventilation and air conditioning in order to comply with the energy efficiency requirements of "Minergie" certified conference centres. The extensive use of bus technology in the planned building services, such as DALI for the lighting and MP Bus for the HVAC, enables it to be integrated into the Saia PCD controller with little effort and operated using web technology. The very high level of flexibility of our programmable controllers and a design based on open-web technology, which made high levels of investment in expensive visualisation systems superfluous, were crucial to the award.

The Lucerne Conference Centre operating and monitoring concept is based entirely on SBC S-Web. It does not require a PC/Windows-based control or management system. Trend data are recorded directly in the automation device and visualised using the available web templates. The system comprises 2000 physical data points distributed among eight PCD3.M3330 automation devices. There are eight 10" micro browser devices installed per system component for operational purposes. There are three 15" web panels with the Windows CE operating system for providing a global overview.

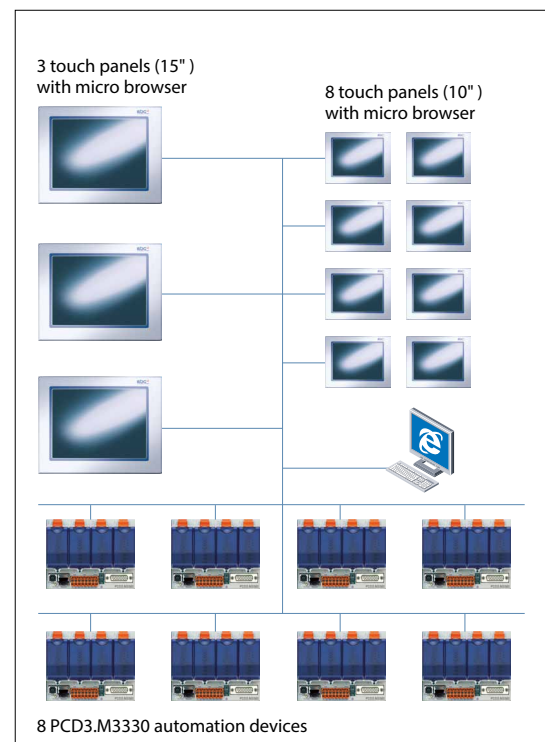

Academic Medical Centre Amsterdam/Netherlands

One of the top ten academic hospitals in the world relies on Saia PCD controllers for improved air-conditioning and reduced energy consumption

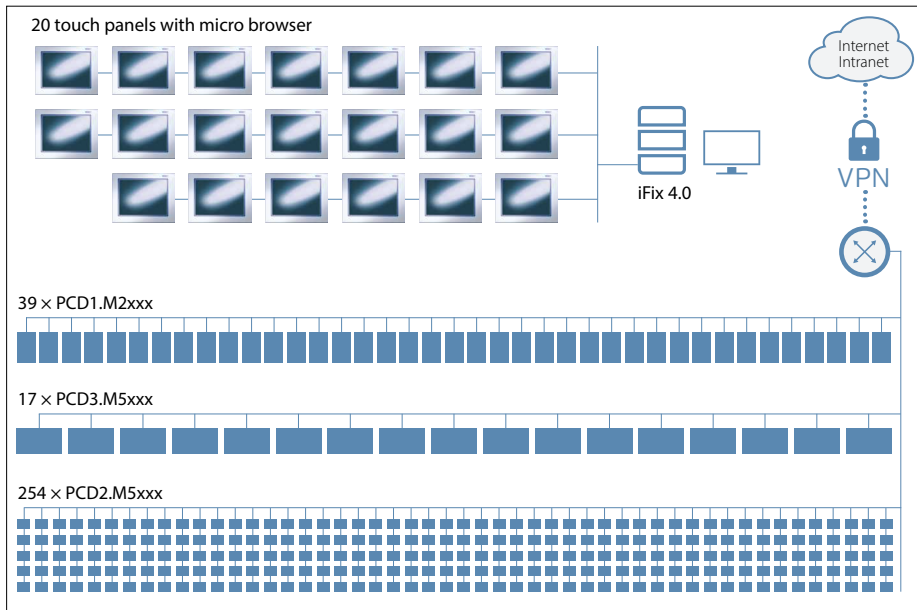

AMC wanted to refurbish and expand the control systems gradually over a period of several years without incurring costs and problems arising from potential changes in automation station generation. They started using Saia PCD controllers in their buildings, processes and utilities in 2000. More than 10 years later, the choice is still considered as the correct one. This is supported by the transparent integration of the newest Saia PCD generation, the general use of Ethernet, data capture on the Flash memory and the reliability of the installed base. The communication capabilities of Saia PCDs enable users to connect to all systems and make the life of the system integrator simpler.

The local conditions in the individual parts of the system and building were resolved in this application using S-Web. A total of 310 automation stations (Saia PCD) are integrated into the property automation system. The entire clinic is operated, controlled and managed as a functional unit. In hospitals, the high volume of visitors and the ventilation/cooling system are "mission critical". In this respect, it is therefore preferable to operate a central iFIX 4.0 PC/Windows-based control/management system parallel to SBC S-Web. In this instance, SBC S-Web cannot make the classic SCADA software totally superfluous.

European Research Centre CERN Geneva/Switzerland

The entire enormous CERN site consisting of 430 operational buildings relies entirely on SBC S-Web. The Web+IT standards mean it needs no dedicated central office or master control/management level.

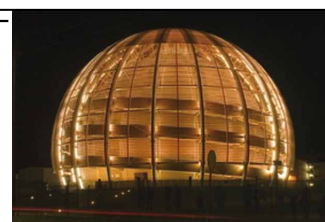

Around 10,000 people work in the 430 buildings at CERN. Each building is fully independent. SBC S-Web forms their control/management level. There is no need for dedicated SCADA software/PC hardware. The existing and already mastered CERN Web+IT technology is sufficient for integrating the consumption data across the site and for monitoring purposes. Operation of the building technology does not require the purchase of, installation of or training on, dedicated Windows software. Automation projects are awarded by CERN throughout Europe. Thanks to SBC S-Web, system integrators all over Europe are able to implement autonomous projects for CERN or improve existing systems. There is no need to involve or reintegrate a central BMS application.

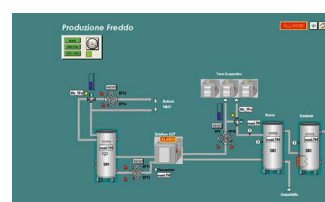

With S-Web, CERN benefits from a technology it invented itself in 1989.

Source: Wikipedia

3.4 Engineering information

Which resources does a Saia PCD® require for SBC S-Web?

The basic structure of an operational S-Web system

The basic structure is simple. Enter the device addresses in the client. The Automation Server of the Saia PCD devices provides the application/data of the Saia PCD. How large and comprehensive can this be in the various types of Saia PCD devices?

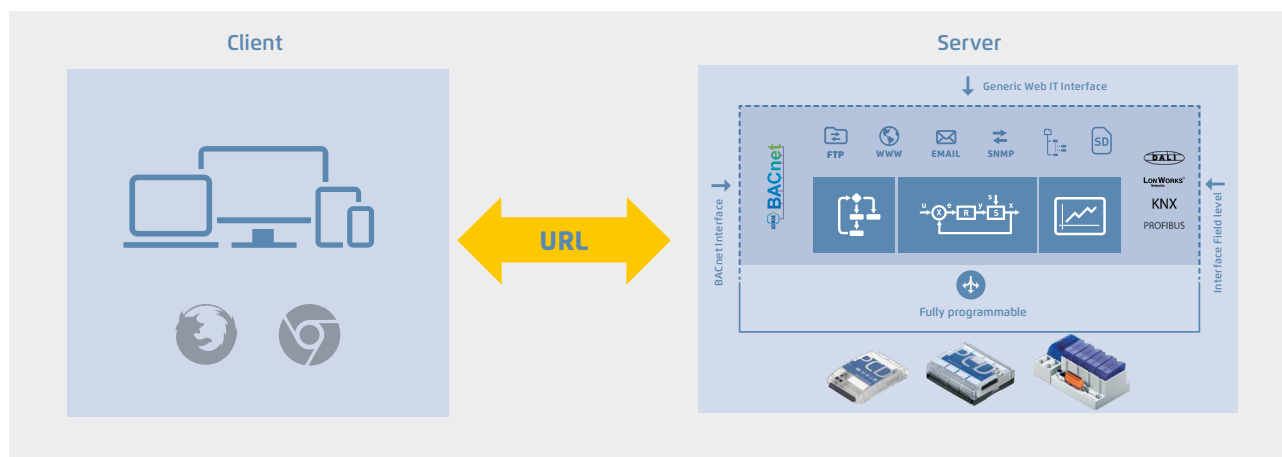

Browser device Which display size?
Which display resolution?
Which device type?

The browser device is usually determined by the mounting/installation location and the requirements in terms of display size and resolution.

Saia PCD controller application server How many data points?
How many trends?
How many images/elements?

The type of controller is determined by the number of required inputs/outputs, the range of functions and the memory requirements.

Basic orientation: Device selection

Every fully independent functional automation system can be illustrated as a hierarchy in the classic form of a pyramid. The differences between systems lie in the scope/power of the respective applications. In other words, the range of required functions and connected field levels.

Pyramids with 2-3 hierarchy levels can be created in the case of large, complex properties. The resources must be designed in accordance with the size of the pyramid and the position at which a Saia PCD automation device is used. The ability to move Saia PCD applications to all three basic platforms and the high modularity even in terms of expanding the memory capacity means that SBC S-Web systems can be continuously expanded even after commissioning. The following illustrates a good basic orientation to ensure the initial installation is compatible.

Basic applications

- ▶ Up to 50 I/Os
- ▶ Up to 20 trends
- ▶ Up to 100 alarms
- ▶ Up to 30 web pages

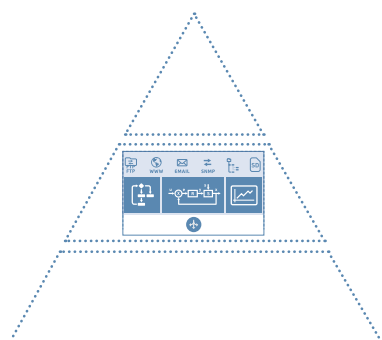

Saia PCD® controller	Max I/O	Program memory	Onboard flash memory	Additional memory	
PCD1.M2120	50	128 kByte	8 MB ¹⁾	1× PCD7.R562	1× 128 MByte
PCD1.M2160	50	1 MB	128 MB ²⁾	1× PCD7.R562	1× 128 MByte
PCD3.M3xxx	1023	512 kByte	---	4× PCD7.R-SDxxx ¹⁾	4× 1 GB

¹⁾ 900 files per memory module

²⁾ 2400 files per onboard memory



The Saia PCD controls and visualises a machine, a simple building with a ventilation system, a heating circuit or a complex room, etc.

Mid-level applications

- ▶ Up to 500 I/Os
- ▶ Up to 60 trends
- ▶ Up to 1000 alarms
- ▶ Up to 100 web pages

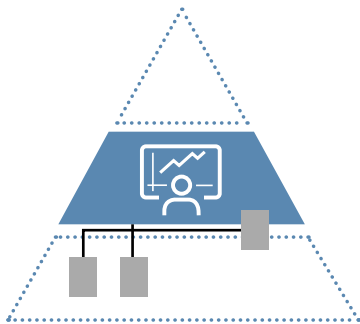

Saia PCD® controller	Max I/O	Program memory	Onboard flash memory	Additional memory	
PCD3.M5xxx	1023	1 MB	---	2× PCD7.R562 ¹⁾ 4× PCD7.R-SDxxx ¹⁾	2× 128 MB 4× 1 GB
PCD2.M5xxx	1023	1 MB	---	2× PCD7.R562 ¹⁾ 4× PCD7.R-SDxxx ¹⁾	2× 128 MB 4× 1 GB

¹⁾ 900 files per memory module



◀ Die Saia PCD controls several system components and includes the SCADA/ visualisation functions of the entire system/all parts of the building

Top-level applications

- ▶ Up to 2500 I/O (entire system)
- ▶ Up to 120 trends
- ▶ Up to 2000 alarms
- ▶ Up to 300 web pages

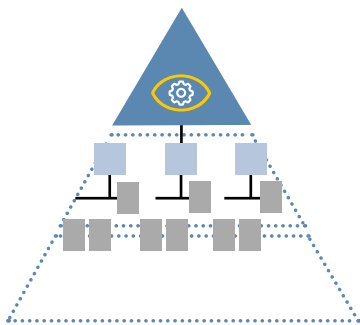

Saia PCD® controller	Max I/O	Program memory	Onboard flash memory	Additional memory	
PCD3.Mxx60	1023	2 MB	128 MB ²⁾	2× PCD7.R562 ¹⁾ 4× PCD7.R-SDxxx ¹⁾	2× 128 MB 4× 1 GB
PCD7.D4xxxT5F	---	1 MB	128 MB ²⁾	---	---

¹⁾ 900 files per memory module

²⁾ 2400 files per onboard memory



Client and server in one device: The Saia PCD7.D4xxxT5F micro browser panels are simultaneously server and client. The demanding control function can be implemented using the Saia PG5® software tool.

◀ The Saia PCD contains the master control and management functions for many distributed systems or large integrated buildings.

Dimensioning the data storage for S-Web applications

The dimensioning of the data storage must take into consideration the size of the web project and the historical data (trend data) that needs to be stored. The following reference values can be used as a guideline to provide a rough estimate.

Memory requirement for S-Web pages:

The calculation of the memory requirements for web pages is based on the number of web pages, number of GIF graphics used and the IMaster Java applets. The following reference values can be used as a guideline to provide a rough estimate.

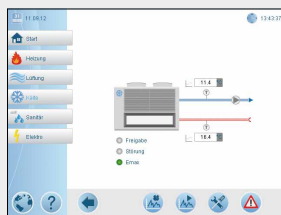

S-Web page approx. 10 kByte/page

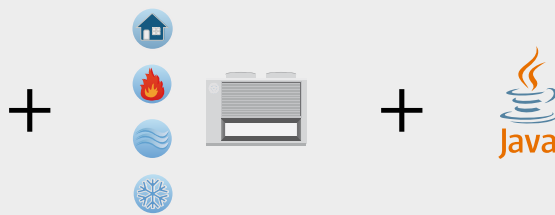

GIF graphics 1...10 kByte

Java Applet approx. 350 kByte

= Memory requirement for web projects

A project with 30 HMI pages will therefore need approx. the following memory requirement:
 (30 × 10 kByte) + (100 × 5 KByte GIF graphics) + 350 kByte = **memory requirement for web project approx. 1150 kByte**

Memory requirement for trend data

Recorded using CSV files in flash file system

The trend data are saved in groups of max. 10 data points per Saia PG5® Fupla FBox and CSV file.

Header.ref.MemoryM1

HDLLog File 3.0

- En Busy
- Val0 WrOK
- Val1 Error
- Val2 Buffer
- Val3 DelRdy
- Val4 IdxStat
- Val5
- Val6
- Val7
- Val8
- Val9
- Store
- WrFile
- DelFile
- Dir

▲ Saia PG5® Fupla FBox records and saves up to 10 data points

➤

	A	B	C	D	E	F	G
1	(s)	Date	Time	Sinuskurve	Sinuskurve1	Cosinuskurve	Cosinuskurve1 Tr
2	1229955202	22.12.2008	14:13:22.438	0	0.99	9.9	9999
3	1229955212	22.12.2008	14:13:32.001	0.019	19.86	9.9	9600
4	1229955222	22.12.2008	14:13:42.000	0.038	38.94	9.2	9210
5	1229955232	22.12.2008	14:13:52.001	0.056	58.46	8.2	8253
6	1229955242	22.12.2008	14:14:02.000	0.071	71.73	6.9	6987
7	1229955252	22.12.2008	14:14:12.002	0.084	84.14	5.4	5403
8	1229955262	22.12.2008	14:14:22.001	0.093	93.2	3.6	3623
9	1229955272	22.12.2008	14:14:32.001	0.098	98.54	1.6	1699
10	1229955282	22.12.2008	14:14:42.000	0.099	99.95	-0.2	-291
11	1229955292	22.12.2008	14:14:52.000	0.097	97.38	-2.2	-2272
12	1229955302	22.12.2008	14:15:02.001	0.09	90.92	-4.1	-4161
13	1229955312	22.12.2008	14:15:12.001	0.08	80.84	-5.8	-5885
14	1229955322	22.12.2008	14:15:22.001	0.067	67.54	-7.3	-7373
15	1229955332	22.12.2008	14:15:32.000	0.051	51.55	-8.5	-8568

➤

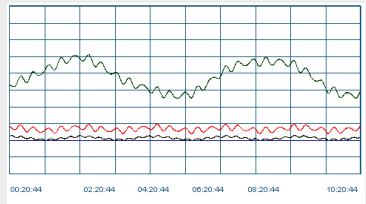

▲ Trend display in the web browser.
A max. of 10 trend curves can be displayed per window

In the following sample calculation, 20 data points are recorded for visualisation in trend curves. 10 data points should be recorded for the optimisation phase at intervals of 1 minute and a further 10 data points should be recorded for long-term monitoring at intervals of 15 minutes.

The memory requirement for 10 data points at 1 minute intervals in one day:

$60 \text{ (mins)} \times 24 \text{ (hours)} \times [30 \text{ Byte (timestamp)} + 10 \text{ (data points)} \times 10 \text{ Byte}] = \mathbf{187.2 \text{ kByte per day}}$

With this quantity of data it is worth creating a new file every day.

The data should be stored in the controller for a month.

This produces a memory requirement of approx. $30 \times 187.2 \text{ kByte} = \mathbf{5.616 \text{ MB per month divided among 30 files.}}$

The memory requirement for 10 data points at 15 minute intervals in one day:

$4 \text{ (15 min.)} \times 24 \text{ (hours)} \times [30 \text{ Byte (timestamp)} + 10 \text{ (data points)} \times 10 \text{ Byte}] = \mathbf{12.48 \text{ kByte per day}}$

With this quantity of data, a new file can be created each week $\rightarrow 7 \times 12.48 = \mathbf{87.36 \text{ kByte per week}}$

The data should be stored in the PCD for a year.

This produces a memory requirement of approx. $52 \text{ (weeks)} \times 87.36 \text{ kByte} = \mathbf{4.53 \text{ MB per year divided among 52 files.}}$

What type of memory modules should be used?

Web pages and log data can be stored in the onboard flash memory and/or the plug-in flash cards.

The web projects and basic data logging with small quantities of data can be stored on the onboard flash memory (depending on the type of CPU) or the plug-in **PCD7.R562** flash memory module. Unlike the onboard memory, flash cards can be exchanged and replaced with new cards. It is therefore easy to archive data or transfer it from one controller to another.

Only the **PCD7.R-SDxxxx** SD flash card module should be used for intensive data logging.

Important information for using the flash memory module

A max. 900 files are supported in a memory module.

S-Web uses up to 70% of the nominal physical memory.

The size of a single file should not exceed 1 MB.

This guarantees that all the files can be sent via the Saia PCD as email attachments.

The calculation examples are reference values without BACnet or Lon communication.

Onboard memory for **6 years** of data monitoring



A Saia PCD3.Mxx60 CPU can record 10 data points for up to 6 years for long-term monitoring in the 128 MB onboard flash memory. The programmable PCD7.D4xxxT5F micro-browser panel and the PCD1.M2160 both also have a large onboard flash memory and are ideal for monitoring tasks. The plug-in PCD7.R-SDxxxx SD flash card with a memory capacity of up to 1 GB lasts even longer and can store data for decades in a Saia PCD controller.



PCD7.R-SDxxxx



PCD7.R562

Internet access without public IP addresses and reducing the load times

The S-Web concept with the SBC Web Connect software (part of Saia PG5® Controls Suite) enables access to all web servers, even with no public IP addresses. This is achieved by installing the SBC Web Connect software on a local frontend PC. In this case, the frontend PC simply requires a registered IP address. This provides all browser PCs (without additional software) on the Intranet and Internet access to the web servers in all PCD devices, and the gateway function also enables this over several network levels. This makes the SBC Web Connect software fully transparent for the user. The connection is established in the browser as usual by entering the URL (e.g. www.frontend.com/PCD-controller/web-page.html). Large files such as images or summary pages can also be stored on the frontend PC to unburden the memory in the PCD controller and to optimise download times. If required, OPC servers or a SCADA system can also be operated on the frontend PC in addition to the web application.

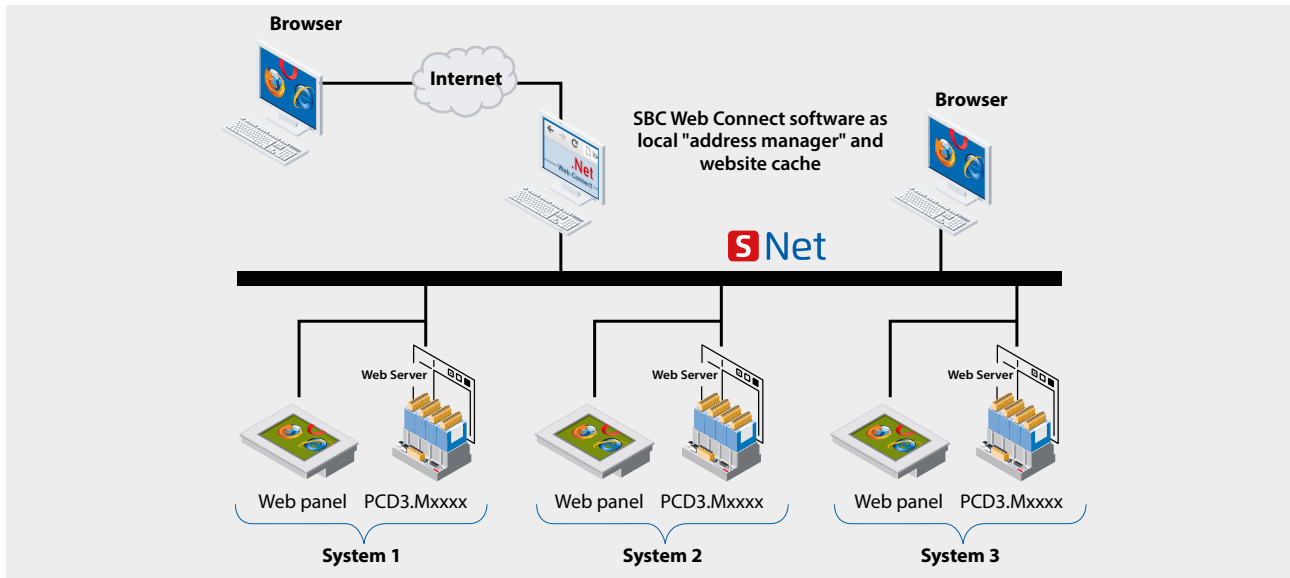

▲ SBC Web Connect can also be used to access the PCD Web Server in the local network even without public IP addresses. The user interface is always the same whether it is operated locally or remotely.

Local or "remote" operation

The same user interface with the same current data from the remote PCD Web Servers is available anytime, everywhere. The remote operation of the data and functions considerably reduces the cost of developing the application, administration and support.

The S-Web operation and monitoring interface is partially independent of the ICA application

The Saia PG5® Web Editor and the Saia PG5® are two independent, autonomous applications. However, the Saia PG5® Web Editor 8 can access the Saia PG5® defined symbols/names direct in the background. Symbols/names that are only used locally can also be defined in the Web Editor application.

The ICA application created in the Saia PG5® does not have to be modified or recreated if the visualisation application is modified. The Web Editor automatically links the defined symbols to the physical addresses used on the automation device.

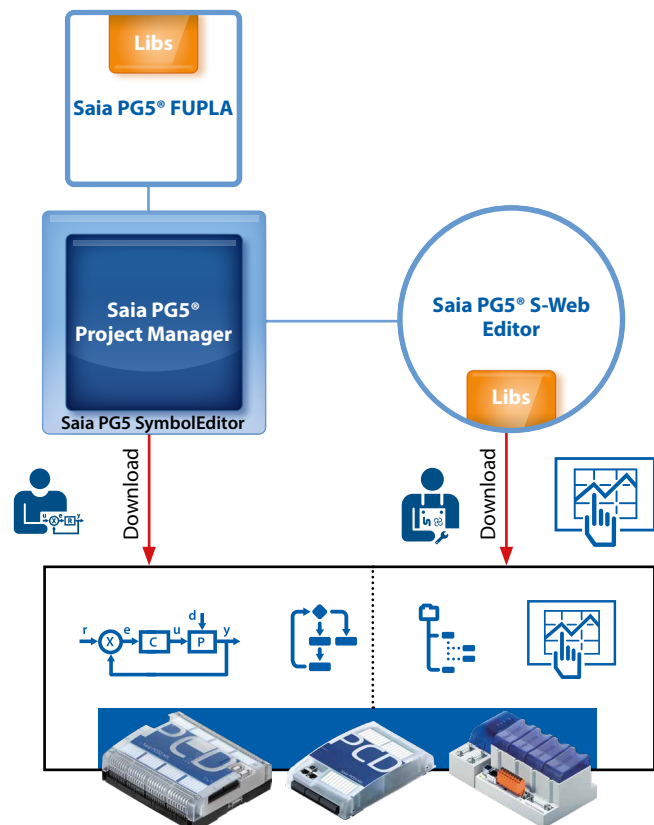

▲ ICA and Web HMI applications can be loaded independent of one another in the PCD controller



If the ICA application is modified so that the physical addresses change (which is the case if Clean All Files is activated, for example), the web application does not have to be adjusted. However, a download is required to link the new symbolic addresses.

3.5 Tender information

What changes with S-Web?

The on-site technology is mainly determined by the planning and tender specification processes. In single incremental developments, it is enough to continue maintaining existing planning and design specification standards. However, if the technological development results in large structural changes, the planning process also requires significant changes that can then affect the resulting tender specification. This chapter is a guide for planners who want to further develop their tender specification standard in this sense.

Technical basis of the "old" automation pyramid

- ▶ Replacement of the analogue control technology
- ▶ Master ↔ Slave
- ▶ MHz/MB PC technology
- ▶ Proprietary/closed technology

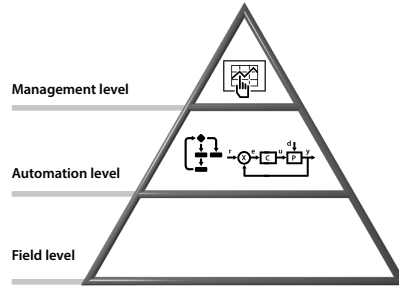

Functional structure of "old" automation pyramids

Core functions of the automation are distributed to various levels and different devices → Proprietary bus diversity, gateways and expensive integration.
 "Total integration" is propagated as an "emergency" solution by large manufacturers.



Technical basis of "lean" automation pyramids:

- ▶ Replacement of dedicated control/management PCs
- ▶ Client ↔ Server/local remote
- ▶ GHz/GByte technology in automation device
- ▶ Web + IT technology/open to all

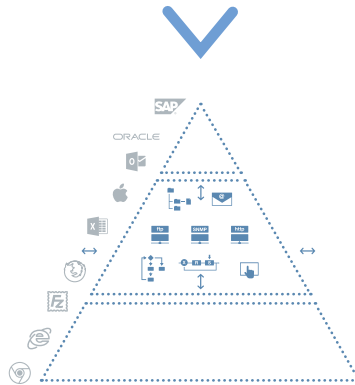

Total integrated system pyramid

Everything from a single source.
 Single operator. Opposite of lean.



Functional structure of "lean" automation pyramids

All core functions of the automation together in one unit is possible.
 Interaction of all devices via Web+IT standards.
 Integration from field to control level provided via LAN/WAN.

SBC S-Web is an innovative system comprising a combination of technical innovations and non-proprietary, globally recognised technologies. It has therefore been steadily developing for more than 10 years. SBC S-Web is causing a paradigm change in automation technology in terms of operation, monitoring and management. It makes the boundaries of the classic automation pyramids transparent and integrated, both internally and externally.

Structure of lean automation systems

All the measuring, regulating and control devices of this structure have the same functional structure and capabilities = SPS + Web + IT
 Each automation device can be included in the client and server relationship with any other automation device and other web/IT technology in the property.

This makes it possible to maximise use, reduce operational expenses and create a highly flexible service life. But how does this impact on tender specifications?

- ▶ Lean automation system: all core functions of the automation (PLC+Web+IT) integrated into that automation device enable the integration and interaction of all devices from the field level to the control level.

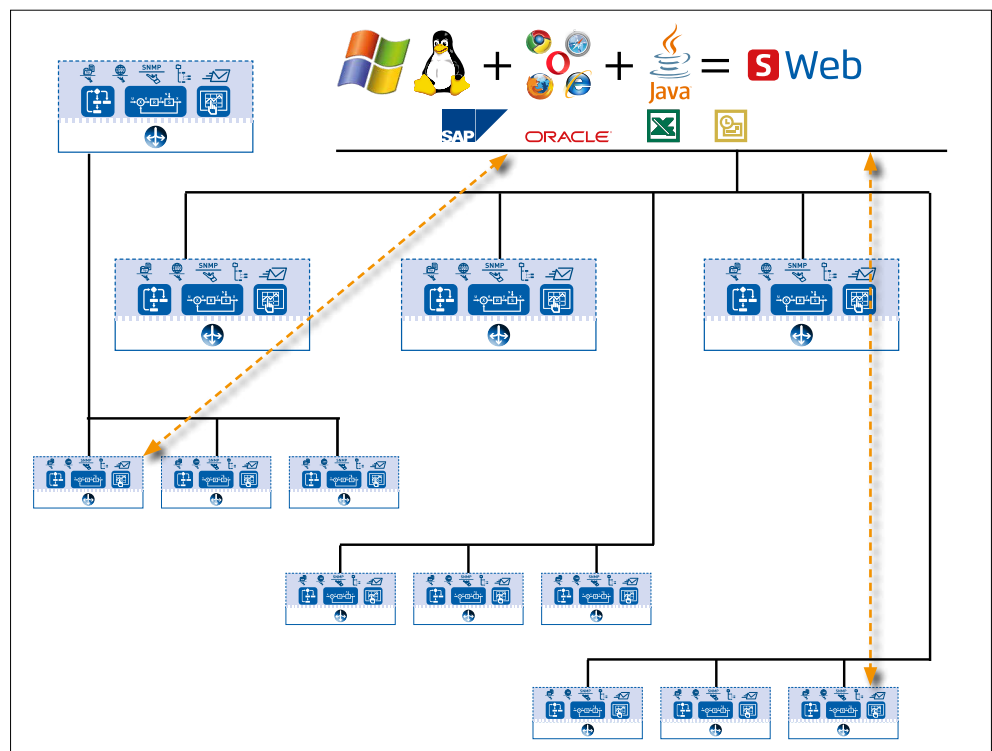

What changes for Lean Automation tender specifications with S-Web?

01.01 LOT: Ludwig-Erhard Street 22.....	17
01.01.01 Network and Building Management system.....	17
01.01.01.01 Network system.....	17
01.01.01.02 Server system.....	18
01.01.01.03 Building Management system	19
01.01.02 HVAC system automation.....	43
01.01.02.01 Hardware.....	43
01.01.02.02 Renovation work.....	48
01.01.02.03 Cables / Installation / Removal.....	48
01.01.02.04 Services.....	48
01.01.03 Room automation.....	50
01.01.03.01 Hardware.....	53

▲ Extract: Structure of a conventional tender specification

1. Should the PC be included in the automation pyramid?

Specifically designed control PC (Windows PC) and control/management software are no longer required for recording and for the regular operation of the ICA technology of a property/site. Each device and system already has its own integrated control/management function.

2. Local versus central – bottom-up versus top-down

In the individual systems, the control/management function is already designed as part of the “automation levels”. This is implemented in the form of SCADA web pages which are loaded via the automation device web servers and displayed in the browser. This allows the maintenance, optimisation and monitoring of a system and all connected devices/equipment. The historical operating data and alarms are stored locally in the automation devices. Analogy: As with SBC S-Web, with BACnet the “SCADA” function is integrated as an object in the BACnet automation device!

3. The end of extremes:

Text displays in the field - 21” system images in the control centre

A single text display on the system does not meet the operator’s needs. A large screen in the remote control centre is also of little help: its complexity is also slightly daunting for non-specialists. S-Web provides usable, practical system conditions “on site” and anywhere a network connection is available. Depending on the complexity of the application, a 5...10” touch panel with web browser is designed for the system control cabinet. A text display is not suitable for the web technology. The local browser panel works only as a client and loads its applications from the control devices (server) as required. Each browser device connected to the LAN/WLAN (PC/mobile device) also has access to the plant operating/monitoring.

15,00 pcs System services SDI V-GLT
Visualisation of the process data
with the following program points:

- full graphical, object oriented plant images (including scanned photos) with dynamic fade-in, change of color and animation
- resp. creation of html pages for web based visualisation
- Operation out of the plant image
- Graphical, user defined selection menus
- Installation and activation of the visualisation

▲ Example of a real design specification for lean automation: Each system already has a SCADA function embedded.

S-Web requires fewer fixed on-site panels compared to classic technology. This reduces costs and saves space.



OZ	Quantity	Unit	unit price EUR	total amount EUR
*** required position without total amount				
03.02.0020		oftware for operator device		
		as OZ (Pos.-Nb. 10))		
		however, as a cabinet operator panel without graphical images and without storing the data to the harddisk		

◀ This separate item is no longer required with SBC S-Web. Browser touch panels require no dedicated software.

4. Quo Vadis: PC-based control/management software?

With S-Web, the entire automated system/ICA operation of a property is ensured without PC/Windows applications. However, classic PC applications are still useful and necessary in many cases. The autonomy of the automation level enables these PC applications to be less closely coupled to the automation pyramid and therefore more “replaceable”. The use of S-Web reduces the service expense associated with integrating PC applications. It is only necessary to implement the truly over-arching, global process views. The system- and object-specific views are already implemented by S-Web and can be requested via a browser.



The PC application undertakes the useful task of automatically capturing the remotely distributed operating data/applications of a property. If the remote data files are not deleted, the backup has a heterogeneous data redundancy.

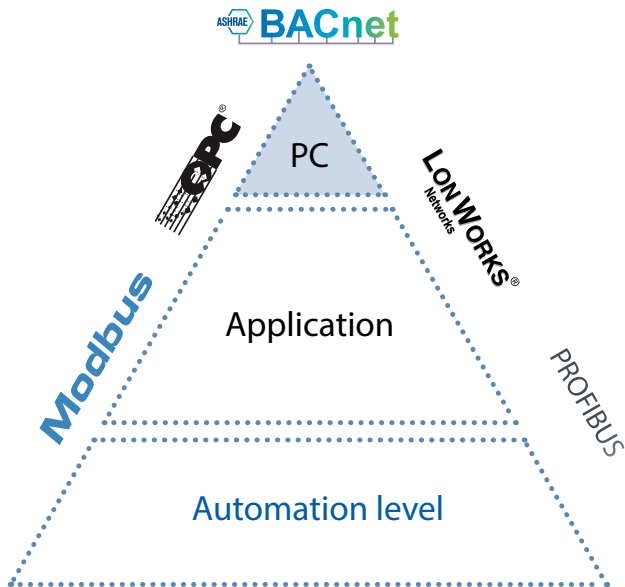

◀ Classic PC-based control and management systems can be easily combined with S-Web. Existing control/management/SCADA software can be used in parallel with S-Web by using tried-and-tested mechanisms (e.g. OPC, BACnet). SBC S-Web also allows access to data direct via the web server CGI calls; with no middleware such as OPC (for more information on this, see page 260 “Web server standard CGI interface”)

Saia PCD® Supervisor: The PC-based management/SCADA software with ideal fit for SBC S-Web.

The Saia Visi.Plus objects/templates are visually/graphically identical to those of SBC S-Web. This means it has the same look and feel both for Windows and browser applications. This makes the boundaries seamless. In practice, SBC S-Web and Saia PCD® Supervisor are often used in parallel. This is particularly the case when optimising the operation of many systems and large properties. Saia PCD® Supervisor can be used with no licence fees required for these tasks. (For more details please see Chapter B1.2 “Application software for Windows PCs”)

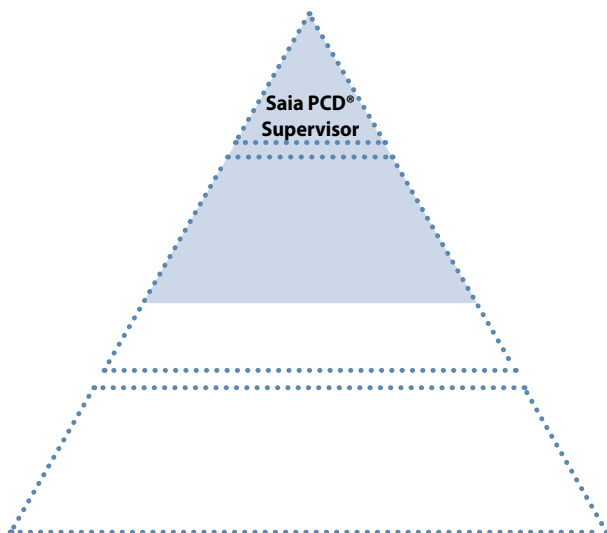

◀ Saia PCD® Supervisor: ideally integrated with Saia PCD and S-Web.

The results of classic tenders

This technology is installed in properties and then has to be maintained and expanded over the subsequent 15–20 year service life!

Superior standard systems and operating stations have access to the system data via special drivers and middleware.



Management/control system hardware PC

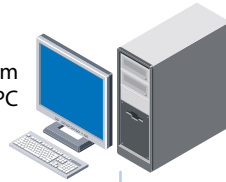

- Management/control system software
- Communication middleware e.g. OPC/BACnet stack etc.
- Windows version xxxx

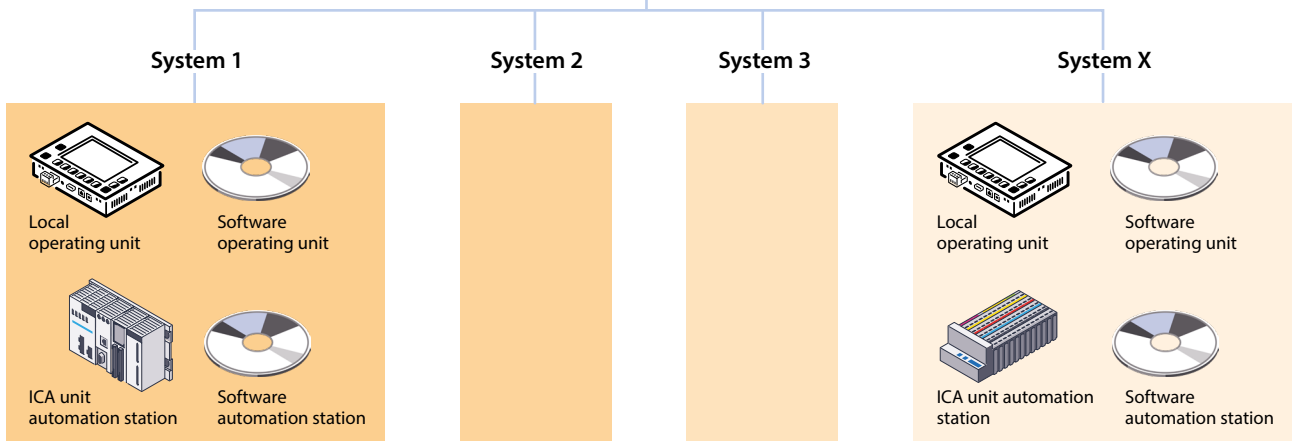

▲ Conventional structure with complex hierarchies → consuming installation, inflexible and expensive in maintenance and care.

The results of lean automation system design specifications with S-Web

The control/management function will be used where it is required. The automated system uses minimal additional software/hardware. Direct coupling of all devices via Web+IT standards – without middleware/special products.

Superior standard systems and operating stations have direct access to the system data anytime, anywhere.

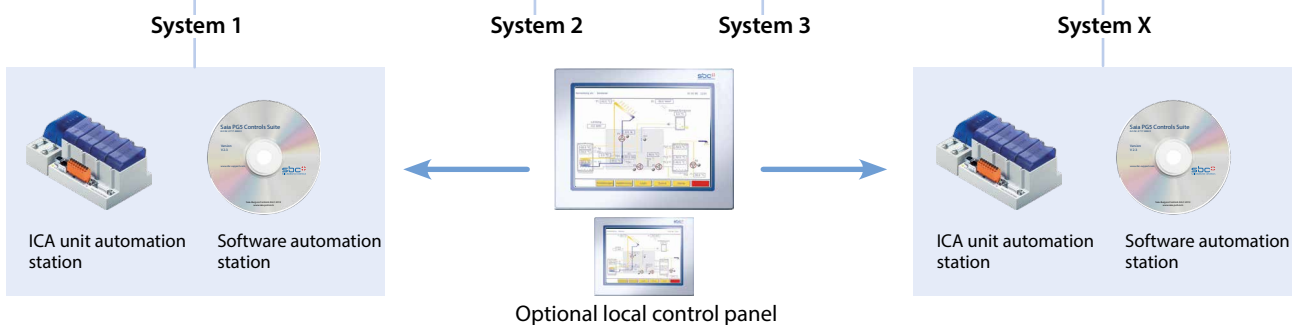
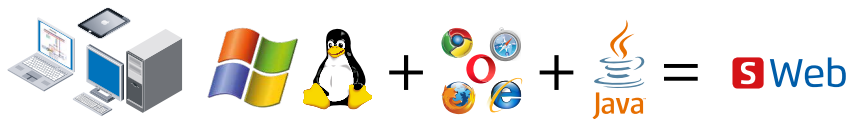

▲ Lean automation with slimline structures:

Web/IT interfaces and SCADA functions integrated into the ICA device → high degree of flexibility and easy to maintain and expand.

3.6 Products/tools

PC Software

Saia PG5® Web Editor
Efficient engineering of graphic interaction interfaces

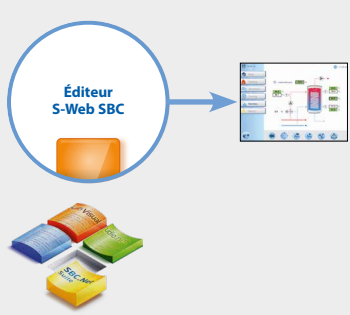

SBC.Net Gateway and proxy server functions

Detailed information in Chapter B1 Software

SBC Micro Browser
Dedicated web browser for automation with SBC S-Web. Integrated into Saia PCD Web Panel MB

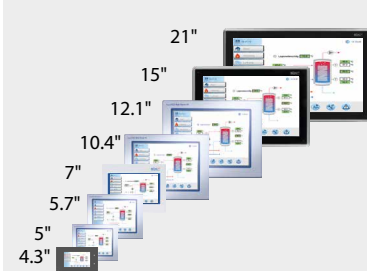
SBC micro browser apps for "third-party hardware"

- ▶ Apple App
- ▶ Android App

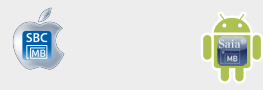

Detailed information in Chapter A2 Operation and monitoring

S-Web accessories

Memory for the automation station to store historical data. **Base module for the SD flash memory**



PCD3.R600

SD flash memory

- 512 MB PCD7.R-SD512
- 1024 MB PCD7.R-SD1024
- Memory module PCD7.R562

Detailed information in Chapter A1.1 Saia PCD System Description

SBC Software
1

Communication and Interaction
2

SBC S-Web technology
3

Room automation
4

Using a SBC S-Web system with devices belonging to the existing infrastructure

Each PC can be used to visualise the Saia PG5® Web HMI pages. The web HMI pages created using the Web Editor are interpreted by a Java applet in the browser on the PC.

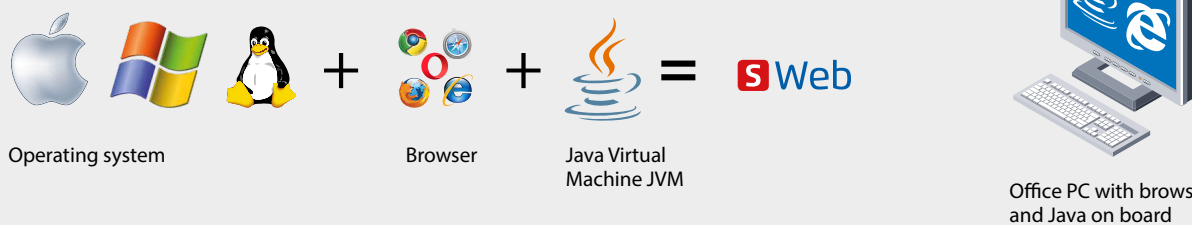

Operating system + Browser + Java Virtual Machine JVM = S-Web

Office PC with browser and Java on board

Any device made available by an operating system with the support of a browser and Java engine can be used with SBC S-Web.

S-Web pages and S-Web projects are created using Saia PG5® Web Editor

The Saia PG5® Web Editor is designed with simplicity and efficiency in mind. Suitable using web technology. The Web Editor also places no limitation on the number of pages and allows maximum freedom in terms of function and design. If that is what you want and need. A large standard library with graphic objects and templates is provided for normal users.

In Web Editor you are not bound to a fixed grid and are free to structure the design and structure of the web HMI pages. Visualisation elements can be arranged freely. System images can aid the user during operation. The entire application can be split into smaller sectional views across several pages.

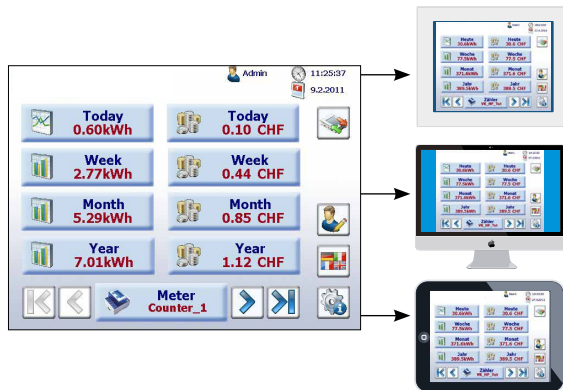

▲ Projects created using the Web Editor can be used across various devices.

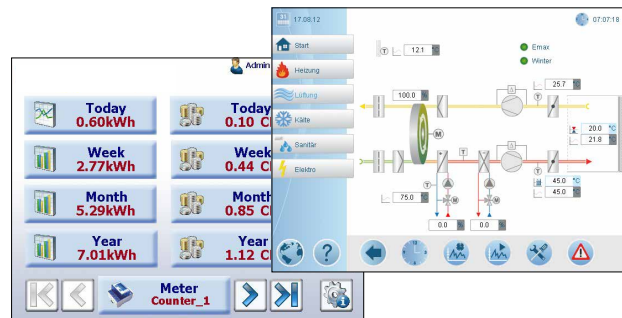

▲ No specifications for the placement of visible elements. Free graphic design possible.

Create once, use on many devices

An S-Web project which has been created using the Saia PG5® Web Editor can be used simultaneously by various browser devices.

The appearance of the page and the operating philosophy do not change.

The S-Web application is executed using a standard web browser and Java applet. With Saia PCD Web Panel the application runs in the SBC Micro Browser, which has been developed specifically for ICA technology/automation.

Implementing management and optimisation functions

The trending and alarming functions are stored as templates in the libraries of the Web Editor and can be used direct in this form.

Various templates are available for displaying trend curves. All the media in the automation device can be historically recorded and visualised in an online trend curve.

The alarming function records and stores alarms and events and visualises current and historical alarms with different template objects.

The templates consist of a collection of standard elements. They can be adjusted at any time as required to the application conditions using Saia PG5® Web Editor. They can also be used as a basis for creating your own collection of templates.

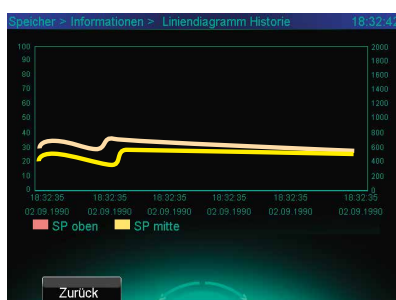

▲ Trending template adjusted to meet the specific needs of the customer

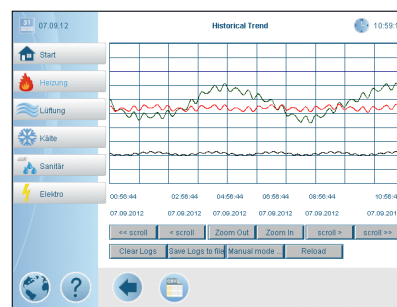

▲ Historical trending with the default template

ID	Alarmtext	Time On	Time Off	ACK/COLO	Pg Up/Pg Dn
1	H01 Pumpe Motorschutz	--	--	--	--
2	RLT01 BSK 1	--	--	--	--
3	RLT01 BSK 2	--	--	--	--
4	RLT01 BSK 3	--	--	--	--
5	RLT01 BSK 4	--	--	--	--
6	RLT01 BSK 5	--	--	--	--
7	RLT01 Frostgefahr	--	--	--	--
8	RLT01 Abzuehler	--	--	--	--
9	RLT01 Aussenluft	27.07.2012 14:00	--	ACK/COLO	--
10	RLT01 ZLV Rueckstaeg. fehit	--	--	--	--
11	RLT01 ZLV Aussenluftwaerme	--	--	--	--
12	RLT01 ZLV Motorschutz	--	--	--	--

▲ Alarming with the default template

Using Saia PCD® HVAC Lib and Saia PG5® DDC Suite templates

The Saia PCD HVAC and Saia PG5® DDC Suite library provide the user with a collection of pre-assembled function and system objects with graphic templates. They are designed for primary HVAC technologies and general building automation systems. The templates can be transferred unmodified and adjusted to the requirements of the application if necessary. A detailed description of the libraries can be found in Chapter B1 Software.

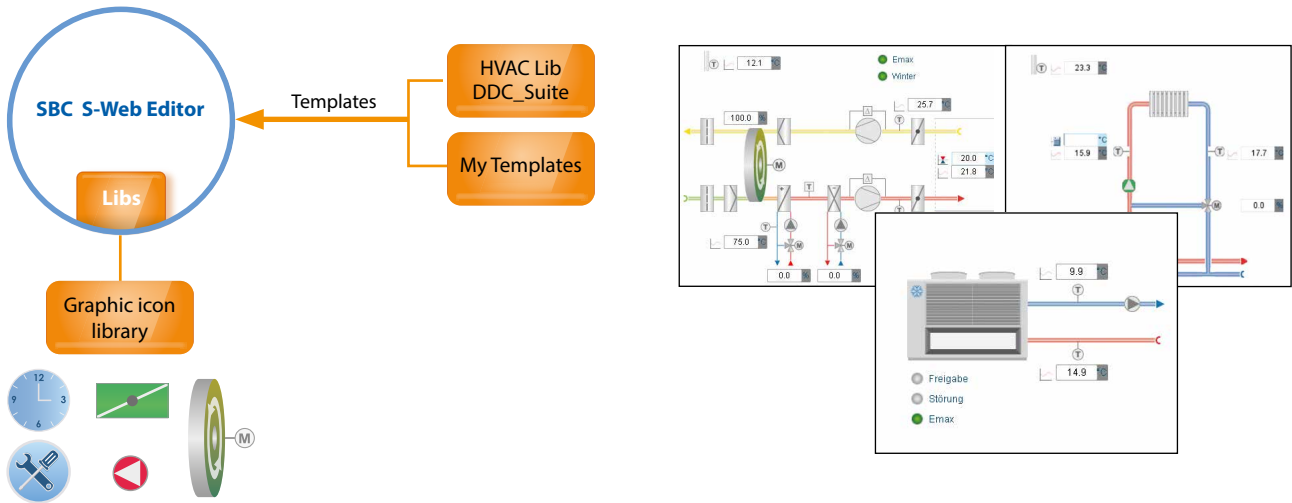

▲ The Web Editor provides the programmer with a comprehensive template and graphics library for efficient engineering. It is also possible to create your own templates.

Minimal time required to create a successful result

Saia PG5® Web Editor makes it possible to achieve a "basic fit" quickly and efficiently. This means that the basic necessary functions for acceptance are implemented.

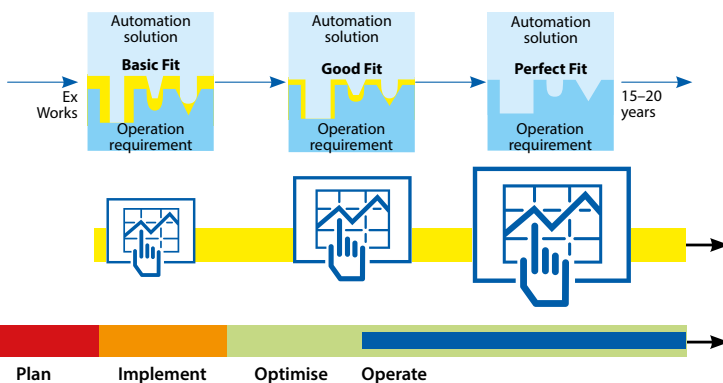

The SBC S-Web application can be adjusted at any time during the initial optimisation phase of the system, and subsequently during continuous operation to meet actual, individual requirements. The way to good fit and perfect is always open, nothing is installed and nothing is closed off.

▲ The maximum degree of engineering freedom is provided over the entire service life for optimisation and adjustment; for operators, installers and service providers.

Adjustment of S-Web projects after acceptance

The S-Web applications of a Saia PCD automation station can be adjusted and expanded independently of the local regulation/logic project. The core ICA functions are implemented using the Saia PG5 software tool and loaded into the Saia PCD. The Saia PG5® Web Editor can also be used to load new S-Web applications into the Saia PCD. It is also possible for several S-Web projects to work on the same automation device in parallel. This enables users to create sub-projects for specific user groups (e.g. for service or operators). It is therefore possible to influence the diversity of the browser devices being used.

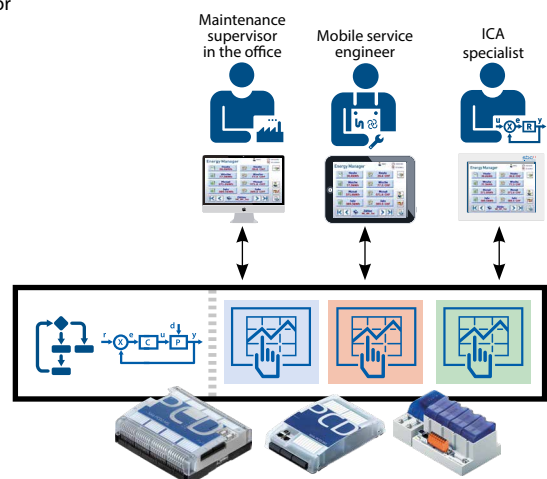

▲ Several HMI applications adjusted/optimised to the respective user groups are possible on one controller.

Standard PCD Web Server CGI interface

The COSinus integrated HTTP web server has a standardised Common Gateway Interface (CGI). The CGI interface supports the direct access (reading and writing) to all PCD media (register, flags, DB/texts, I/Os, etc.) as well as on the file system (up/download, delete, ...)

A client (browser, Java or MS.Net application) can then access the data on a PCD controller by entering the URL and corresponding CGI command direct (with no specific drivers required).

Java, .Net Application

```
static void getFileStream(string URI, string Folder, string Filename)
{
    // INIT WebClasses
    WebRequest MyWebRequest;
    WebResponse MyWebResponse;

    MyWebRequest = WebRequest.Create(URI);
    MyWebResponse = MyWebRequest.GetResponse();

    Stream stream = MyWebResponse.GetResponseStream();
    .
    .
}
```

URL command in web browser

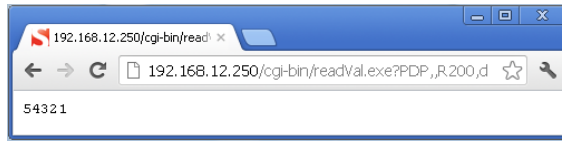

SBC Micro Browser



The Saia PCD Web Server processes requests/orders via the CGI interface and sends the client the relevant information.



Microsoft.Net or Java already have the categories "WebRequest" and "WebResponse" available for requests made to a web server.

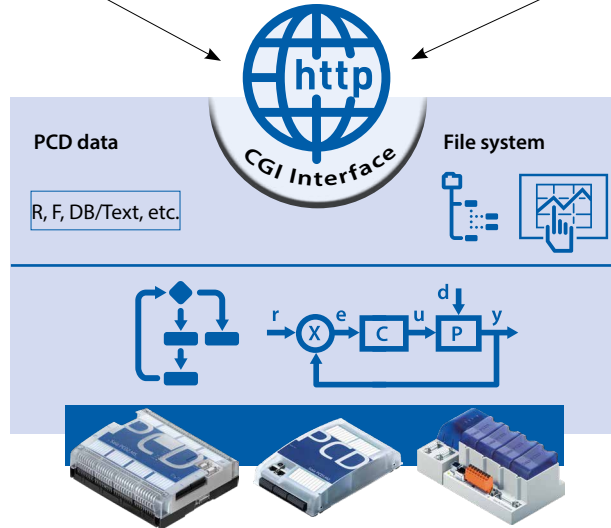

▲ The Saia PCD Web Server provides an open CGI interface in addition to the HTTP server.



SBC.Net Suite

The SBC.Net Suite includes components and class libraries for communicating via S-Bus (master and slave) or the CGI interface. It enables the basic integration of Saia PCD data in a Windows application without worrying about communication drivers (middleware) or CGI syntax. Further information is contained in Chapter B1 Software.

Accessing the Saia PCD® Web Server with MS Office applications

Microsoft Office products support the integration of external web sources. This makes it very easy to visualise the data of a Saia PCD controller in an MS Office application. The MS Office products can also access via the CGI interface of a Saia PCD Web Server to read or write data using the VBA programming language.

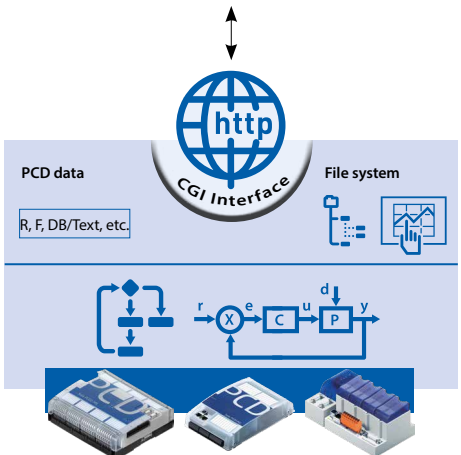
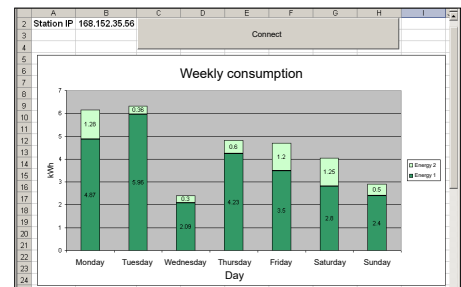

Saia PCD data can be linked to a cell using Microsoft Excel. The data in the linked Saia PCD will be permanently updated while the Excel application is running. All this with no specific driver software/ middleware required by other systems.

3.7 Using an Automation Server as a technical basis for S-Web

An Automation Server is part of the COSinus operating system and is therefore integrated into all Saia PCD controllers. It comprises common web/IT technologies and guarantees the exchange of data between the operator/user and automation without any proprietary hardware or software. Specifically adjusted automation functions and objects form the relevant counterpiece in the controller application. The IT/web functions are therefore seamlessly and optimally integrated into the automation device and can be used efficiently.

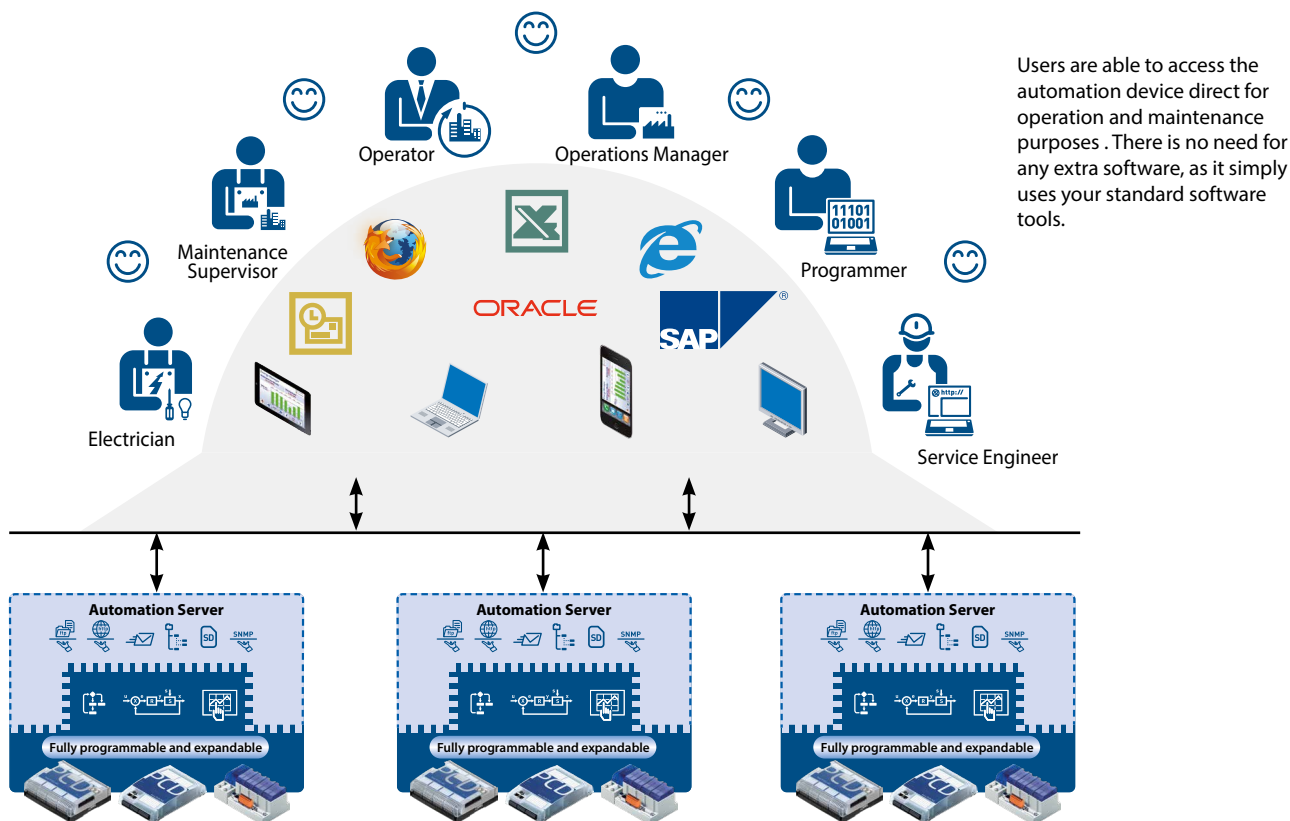

Ideally, every automation device will have an Automation Server: each device can be accessed equally, and complex communication hierarchies are unnecessary.

Automation Server components



Web Server

The system and process are visualised in the form of web pages and can be requested from the web server using browsers such as Internet Explorer, Firefox, etc.



FTP Server

Load files into or select files in the automation device over the network using a standard FTP client (e.g. Filezilla).



File system

Process data, records, etc. are stored in easy-to-access files. Standard formats make it easy to process them further, e.g. with Microsoft Excel



Email

Critical system statuses, alarms and log data can be sent by email.



Flash memory

Their large storage capacity means Saia PCD controllers do not rely on a master PC system, even over a long period. The data storage capacity of the Saia PCD controller can be expanded to up to 4 GB by installing a SD flash card.



SNMP agent

Messages and alarms are transmitted in accordance with IT standards. Access to automation data using the IT management system.

SNTP, DHCP, DNS, etc.

Other standard protocols for simple integration into existing IT infrastructures

B4 Room automation

Room automation is a crucial component for room comfort and also reduces operating costs to efficient levels. Energy efficiency therefore plays a vital role along with a comfortable interior temperature and the intuitive operation of the various room functions. This can be achieved by room automation from SBC.

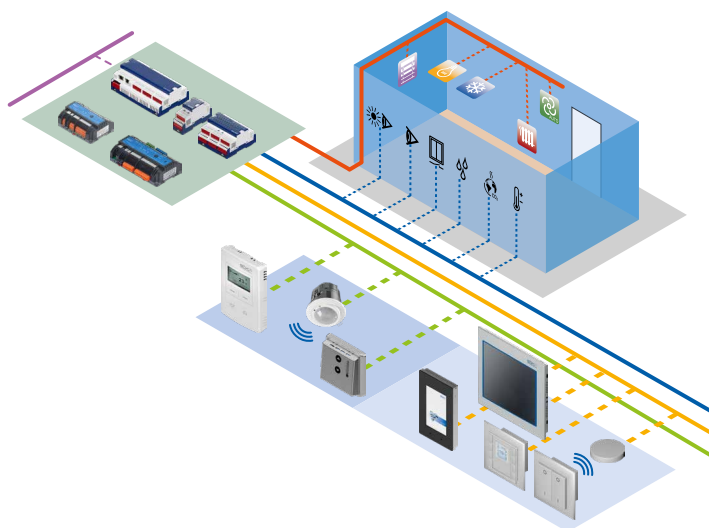

4.1 The objective of room automation

Page 238

The objective is to maintain a comfortable interior temperature for the user, which should be achieved by consuming a minimal amount of energy. The optimisation potential of occupancy and changes of use can therefore be exploited.



4.2 Room automation with SBC components

240

All the SBC components suitable for room automation will be displayed. They will be assigned to various segments and areas of use for a better overview.

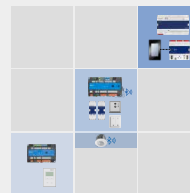

4.3 Examples of application

245

The various practical examples of application clearly demonstrate the versatility and efficiency of SBC room automation.



4.1 Objectives of room automation

Save building operating costs, lower CO₂ emissions and increase user comfort

The objective is to maintain a comfortable interior temperature for the user, which should be achieved by consuming a minimal amount of energy. The optimisation potential of occupancy and changes of use can therefore be exploited. Energy efficiency and conserving resources will become increasingly important in the future and play a decisive role in the implementation of projects. New standards, regulations and laws are constantly being introduced to increase awareness of this.

Objectives of room automation

- ▶ Ensure a reasonable level of comfort during occupancy
 - ▶ Cut the cost of energy required for operation
 - ▶ Protect the environment and conserve energy resources
- A crucial factor here is monitoring, and the user's ability to intervene.

Comfort with room automation

We spend most of our time in closed rooms. This is why the quality of the temperature and conditions in the room is vital for our health and wellbeing and, for functional buildings, the environment also influences productivity at work. In this case, the factors are influenced by various services. These are, for example, the HVAC services (pleasant room temperature and good air quality) and the electrical services (e.g. light for sufficient brightness or blinds to prevent glare, the effects of daylight and thermal radiation). An interdisciplinary cooperation of various services and plants is required to control these influencing factors. This can be achieved using cross-plant automation functions and the appropriate components.

Energy and room automation

The building sector accounts for 40% of overall energy consumption in the European Union (EU). Of this, 85% is for room heating and cooling and 15% for electrical energy (particularly lighting).

There is enormous potential for energy optimisation here.

Building automation plays a decisive role in this, along with thermal isolation and the use of energy-efficient devices. The complete networking of heating, cooling, ventilation, lighting, shade and additional systems make the building intelligent. This is the key to energy efficiency and optimises the operating costs of a building. The operating phase of a building is crucial, as 80% of the service life costs are accumulated in the operating phase. 50% of this figure is energy costs that could be reduced with intelligent building automation.

Operating costs per annum in % of the construction costs

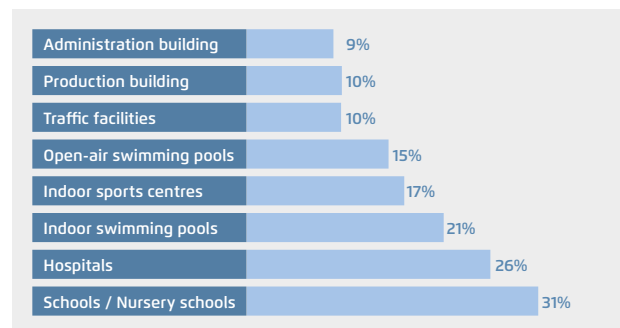

Source: Helbing Study

The existing potential is also demonstrated through a study by the University of Hannover for Applied Science and Art. In air-conditioning technology, energy savings of over 30% can be achieved and this figure rises to 60% for lighting. Further investigations and studies also demonstrate an immense potential for savings.

Standards and regulations

The challenges of changing energy policies and increasingly strict CO₂ constraints have resulted in new guidelines. One example is the EPBD, which stipulates the improvement of the overall energy efficiency of new buildings.

European Energy Performance of Buildings Directive – EPBD

The latest European Directives (2010/31/EU and 2012/27/EU) required Member States to introduce, implement and monitor the quality of building energy efficiency in various areas. The guidelines include a method of calculating overall energy efficiency. Calculation of the energy requirement with additional specifications for heating, ventilation, cooling and electrical energy.

Extract: Technical building systems, such as heating systems, warm water systems, air-conditioning and large ventilation systems, must meet the requirements for overall energy efficiency, regardless of whether they involve new systems or the replacement or modernisation of such systems.

Certain regulations and recommendations exist for room automation in various countries. A brief extract:

- DIN EN 15232 “Energy Performance of Buildings: Impact of Building Automation and Building Management”
- VDI 3813-1 “Fundamentals of Room Control”
- DIN V 18599 “Energy Efficiency of Buildings”
- EnEV Energy Saving Regulation

This topic is described in greater detail based on the following example.

EN 15232 "Energy Performance of Buildings – Impact of Building Automation and Building Management"

The EU Directive EPBD includes the standard EN15232, which contains the following:

- ▶ A structured list of the control, BA and TGM functions that influence the energy efficiency of buildings.
- ▶ A simplified method to obtain an initial assessment of the influence of these functions on the energy efficiency in typical buildings.

Energy efficiency classes of building automation

Class A: High-energy efficiency room automation and networked plants and services

Class B: Optimal solutions for each plant or service, partially networked

Class C: Standard room automation, reference document

Class D: No room automation, not energy efficient

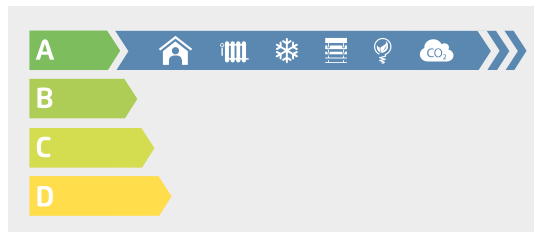

Room automation and its implementation is an important aspect of the assessment!

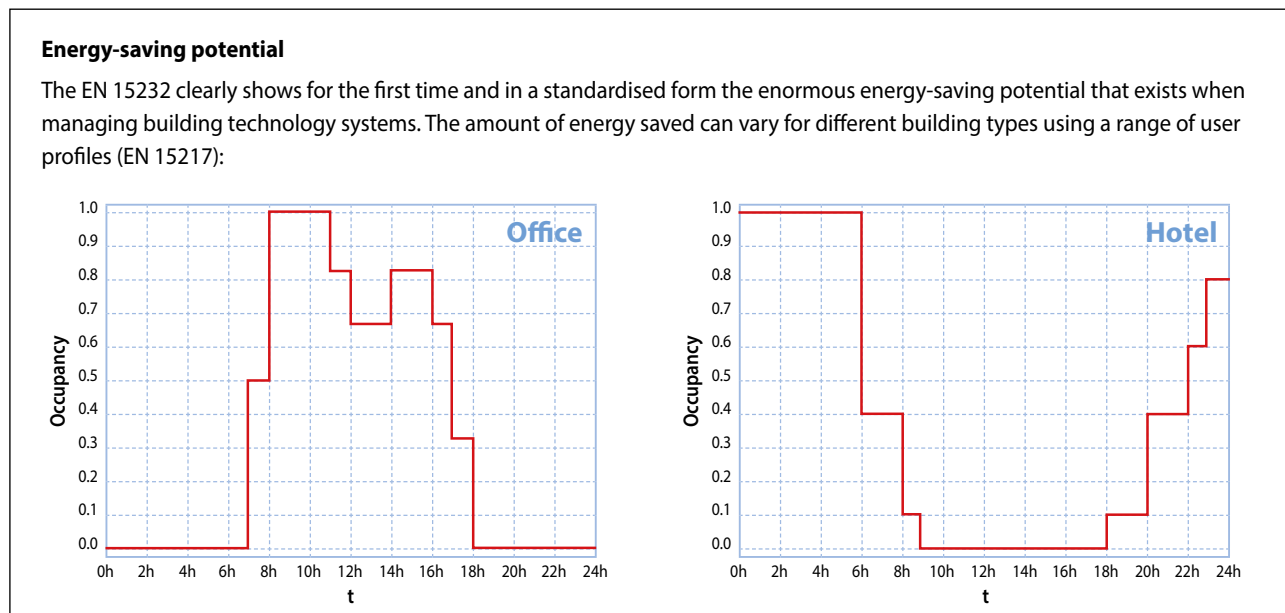

Examples of essential measures for the EN 15232 rating:

Class C:

- ▶ Central control of the room temperature
- ▶ Lighting with manual setting/dimming
- ▶ Simple sun-protection automation

Class A:

- ▶ Networked temperature control for individual rooms
- ▶ Light control in accordance with requirements
- ▶ Networking of blinds and light control with heating, ventilation and air-conditioning systems
- ▶ For VAV: Load-dependent control → via an air quality sensor in the room

Energy-saving potential

Savings with thermal energy (heating/cooling)

	Office building	School	Hotel
A	0.70	0.80	0.68
B	0.80	0.88	0.85
C	1	1	1
D	1.51	1.20	1.31

30% 20% 32%

Saving potential by retrofitting Class C in accordance with A

Energy-saving potential

Savings with electrical energy (lighting/sun protection)

	Office building	School	Hotel
A	0.87	0.86	0.90
B	0.93	0.93	0.95
C	1	1	1
D	1.10	1.07	1.07

21% 20% 16%

Saving potential by retrofitting Class D in accordance with A

4.2 Room automation with SBC components

SBC has various products available for room automation. Depending on the task, various components are used for this that were described in section A. The product groups will be briefly presented again below, and subsequently subdivided. The objective is to assess as quickly as possible when and where certain products can be used to meet the relevant requirements.

4.2.1 Product overview for room automation applications

The products in section A, which lists their technical specifications, will be split into controllers and control units for room automation, and will be described briefly.

Controllers:

- ▶ **PCD7.LRxx** BACnet-Room controllers configurable via Android-app
 - ▶ **PCD7.LRxx-P5** Room controllers freely programmable with PG5
 - ▶ **DALI64SYLKPSUx** DALI lighting system with BLE and Sylkbus interface
 - ▶ **PCD1 E-Line** freely programmable E-Line modules and E-Line RIOs for I/O extension
 - ▶ **PCD1.M2220-C15** PCD1 with Ethernet TCP/IP for room automation applications
 - ▶ **PCD controllers** all additional Saia PCD automation stations
-

Control units:

- ▶ **Sylk-Bus** Room control units with Sylk-Bus connection
 - ▶ **EnOcean** Wireless Room control units from PEHA (EnOcean)
 - ▶ **PCD7.D1000** Room control units with ModBus or S-Bus connection
 - ▶ **PCD7.D443** Room Panel
 - ▶ **PCD7.D4xx** Web Panel MB and pWeb Panel MB
-

Controllers



PCD7.LRxx – BACnet room controllers configurable via Android-app

The configurable BACnet room controllers of the PCD7.LRxx have integrated applications for standard fan coil, inlet air dampers with air quality control, radiator or chilled ceiling control and enable efficient and time-saving commissioning and testing of the connected actuators and sensors via an Android-App.

They have a SYLK bus interface for connecting digital room control units.



PCD7.LRxx-P5 – Room controllers freely programmable with PG5

The S-Bus/Modbus room controllers freely programmable with Saia PG5®, can be fully integrated into the Saia PG5® controls suite and are suitable for flexible and individual space solutions. Two interfaces that can be configured as S-Bus or Modbus enable the integration of digital room control units or expansion modules - this is how the room controller can be combined with existing SBC PCD1 E-Line modules.

This allows more complex applications and trades to create comprehensive HVAC, lighting and shading room control solutions which makes it ideal for the realization of energy-efficient and individual room automation. It also provides a good basis for achieving energy efficiency classes according to EN 15232: 2012.. In addition, it has a Sylk bus interface for connecting digital room control units.



DALI64SYLKPSUx - DALI64 lighting system configurable over Light touch app

DALI64 is a fully featured standalone DALI lighting control system embedded into a state of the art PIR sensor with an advanced lens design.

The DALI64 natively integrates over Sylk-bus with PCD7.LRxx-P5 freely programmable room controller and BMS to create integrated room control systems and enables with that smart integrated building solutions.

A simplified commissioning will be enabled with the intuitive Light Touch commissioning App.



PCD1 E-Line (PCD1.Xxxx-xxx)

The PCD1 PG5 freely programmable E-line modules and E-Line RIO which can be used for I/O expansion for HVAC, lighting or shading control.



PCD1.M2220-C15

The Saia PCD1.M2220-C15 has been specially designed for installation in electrical sub-distribution. It is a freely programmable room controller for sophisticated solutions with different communication options and acts as a master for the attached controllers and modules. It can take on more complex regulations as well as form the interface to the management level. The integrated Automation server and the Web + IT functions can be used directly to visualize the control via web panel or browser. With the support of numerous protocols such as BACnet, LON, Modbus, etc., the Saia PCD E-Line CPU is the ideal interface to other trades.



Saia PCD controllers

Saia PCD controllers have sufficient system resources to operate up to 13 communication interfaces in the same device. Even the most demanding tasks, such as simultaneous communication via BACnet® and Lon IP, can be managed reliably.

Any challenge can be met with a Saia PCD owing to its flexible operation and high level of reliability.

Control units



Sylk bus room control units

Room control units with polarity-independent 2-wire Sylk bus connection for power and data transmission. 8 different variants of integrated sensors for temperature, humidity and CO2 sensor and LCD display with function keys in maximum configuration can be used with the configurable room controllers PCD7.LRxx and with PG5 freely programmable room controllers PCD7.LRxx-xx.



Wireless room controllers from PEHA

Control units from the PEHA are an outstanding addition to the Saia PCD controllers. The room control units using EnOcean combined with the fully programmable PCD1 E-Line products or the PG5 programmable room controllers for example, are ideally suited for room automation applications. A wide range of control units is available which are easy to operate.



PCD7.D1000 ModBus / S-Bus room control units

Room control unit with Modbus/s-Bus connection via 2 RJ9 plugs for series connection of up to 6 devices. Can be used for room temperature detection and setpoint adjustment. PEHA Dialog Aluminum design with 7 LEDs for signaling the setpoint shift.



PCD7.D443WTxR Room Panels

The programmable panels have an attractive design. Independent room applications with the integrated logic controller enable the control of room functions without a head station. Delays through long communication channels associated with this are eliminated. The temperature of the room or zone can also be determined and transmitted to another controller. The graphics can be customised and therefore adjusted for any requirement.



PCD7.D4xx Web Panels MB and pWeb Panels MB

The Saia PCD7.D4xx Web Panel MB and pWeb Panel MB are equally suitable for room automation. This is particularly true when executing and displaying tasks of greater complexity. The use of the S-Web technology combined with the micro browser panel systems is a great advantage. The operation can be displayed transparently and clearly for every user. Each individual control side has a flexible design and can be created with Saia PG5 using the standard objects or existing function templates.

4.2.2 Segmentation of the room components



There are three main areas. The classification of the products is based on the following main points and features:

- ▶ **Application diversity and area of application**
Is only a single heating circuit controlled in one room, or should light or shading and additional tasks be performed and cross influences observed?
- ▶ **Configuration or programming**
Pure configuration or flexible programming throughout the entire service life?
- ▶ **Communication capability**
Must only S-Bus and also other communications protocols such as DALI, ModBus, EnOcean,... or web functionalities be supported.

SBC Software

1

Communication and Interaction

2

SBC S-Web technology

3

Room automation

4

Segment / Field 1

Configurable room controllers with BACnet interface are required to implement an HVAC standard applications. The standard main applications that can be implemented with these configurable SBC components are heating and/or cooling, fan coil or inlet air flap control with air quality control.

Segment / Field 2

Room controllers programmable with PG5 which can be fully integrated into the Saia PG5® Controls Suite are required to implement a flexible HVAC, light and/or shade application. Through the second RS-485 interface, it is possible to connect the E-Line RIO modules for I / O extension for HVAC, light or shading control or the E-Line Dali module for Dali interface light actuators or via the Sylkbus interface, it is possible to easily integrate the DALI64SYLKPSUx lighting control system. This provides a good basis for the creation of cross-functional room automation functions to achieve the highest energy efficiency classes according to DIN EN 15232 and thus avoiding high energy costs and at the same time great comfort for the end user to receive.

Segment / Field 3

The greatest communication diversity, Web+IT-functionalities and total flexibility are required for the programming. An example would be a Saia PCD1 with DALI interface, EnOcean connection, BACnet and web operation.

4.2.3 Examples of application for the individual segments

The example shows a room with 3 different applications.

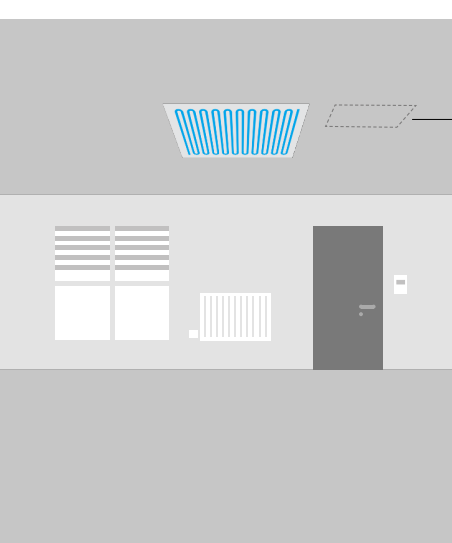

Segment/Field 1

Example of a simple HVAC application

- ▶ **Room controller PCD7.LRS4 + PCD7.LR-TR42:**
- ▶ **Heating:** Radiator with electrothermal valve drive
- ▶ **Cooling:** Cooling ceiling with constant valve drive (0...10 V)
- ▶ **Room temperature measurement:** NTC10K integrated in the controller
- ▶ **Local user prompting:** Directly on the controller via presence and setpoint offset setting
- ▶ **S-Bus connection to floor control for, among others:** control of operating mode changeover, setpoint specification and reading of actual values.



Segment/Field 2

Example of a cross-service/plant application with HVAC, light and shade

- ▶ **Room controller system:** PCD7.LRL4-P5 + DALI64SYLKPSUF + PCD7.LR-TR42-CO2
- ▶ **Heating 1st stage:** Floor heating with electrothermal valve drive
- ▶ **Heating 2nd stage:** FanCoil unit
- ▶ **Cooling:** FanCoil unit
- ▶ **Room temperature measurement:** NTC20K in PCD7.LR-TR42-CO2 control unit or external NTC sensor
- ▶ **Light and shade:** Control of 6 group and scenes of up to 32 DALI lamps and 1 blind
- ▶ **Local user prompting:** Sylk-Bus room control unit for setpoint offset setting and fan speed adjustment and DALI switches and Scen plates for activation of lights and switches for blinds
- ▶ **S-Bus connection to floor control for, among others,** control of operating mode changeover, setpoint specification, activation of lights and blinds, read back occupancy state, lamp running hours and failure states, and reading of controller actual values.

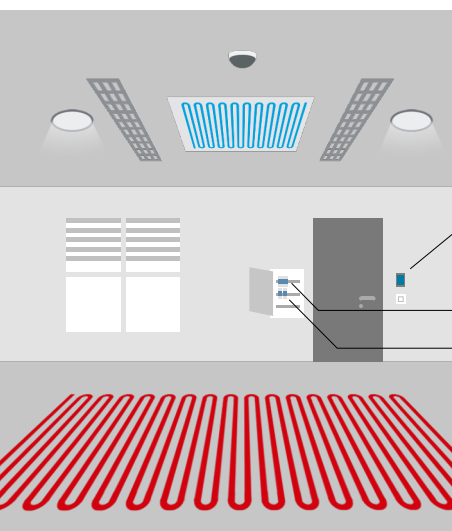

Segment/Field 3

Example of a flexible PLC-based room automation with Web&IT

- ▶ **Components:**
PCD7.D443WT5R + PCD1.F2611-C15 + PCD1.G1100-C15
- ▶ **Heating:** Floor heating with electrothermal valve drive and via fan coil system
- ▶ **Cooling:** Cooling ceiling and VAV system
- ▶ **Ventilation:** VAV system
- ▶ **Air quality control CO₂, VOC,** measurement via externally connected sensor
- ▶ **Light and shade** Activation of 1...10 V lamps, DALI lamps and blinds
- ▶ **Room temperature measurement:** via a room control unit
- ▶ **Local user prompting:**
Room control unit for setpoint offset setting, activation of lights and blinds
- ▶ **Web user prompting:** everything also can be controlled via web
- ▶ **Presence recognition and brightness measurement:**
via sensor for automatic control of light and shade
- ▶ **S-Bus or other protocol (for example BACnet):**
Connection to the floor distributor or direct to the GLT

4.3 Examples of application

In addition to the right selection of components, the architectural structure and the basic concept play a decisive role. There are many possibilities and approaches for implementing room automation. However, there is no “single” solution for all areas of application. Depending on the purpose, the choice of the best concept will vary. Some approaches and features:

Room automation from a central point

A sub-distribution per floor or section supplies several rooms. The control of lighting with DALI for several rooms would be a practical example of application. More cabling is involved with this variant. However, all components are located at a central point, which makes maintenance work more efficient.

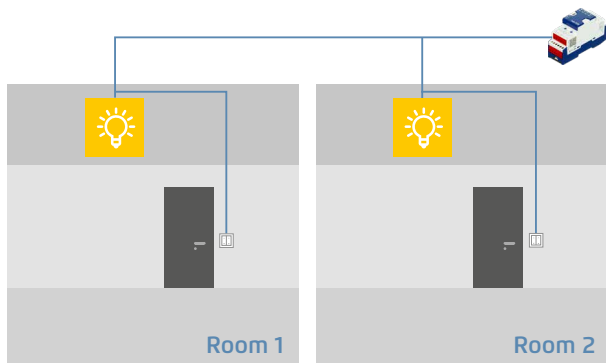

Room automation with distributed intelligence

Components are distributed throughout the floor or room. These are also installed where they are needed, i.e. the controller for fan coil control located near the fan coils. The cabling takes less time, the devices also function independently (= secure operation).

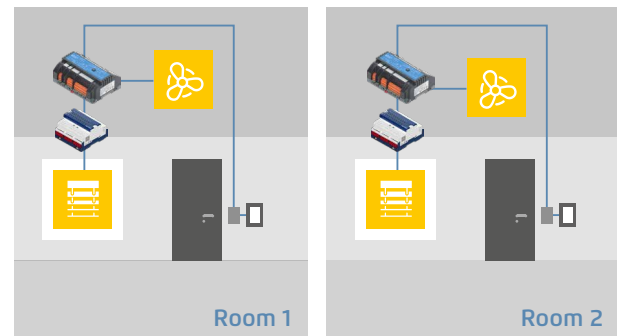

Room boxes

These are ideal if the rooms or their applications are largely identical and/or are numerous, i.e. in hotels and office rooms. The boxes are manufactured and tested prior to installation in accordance with the requirements. The commissioning can thereby be 100% planned and controlled based on the installation time. Only the mounting, connection (usually with finished cable), testing, etc. is carried out on site. ...

The simple and efficient maintenance and servicing of the system is also possible.

The plug-in system of box A ensures quick and seamless “plug & play” installation and replacement. Servicing is less time-consuming.

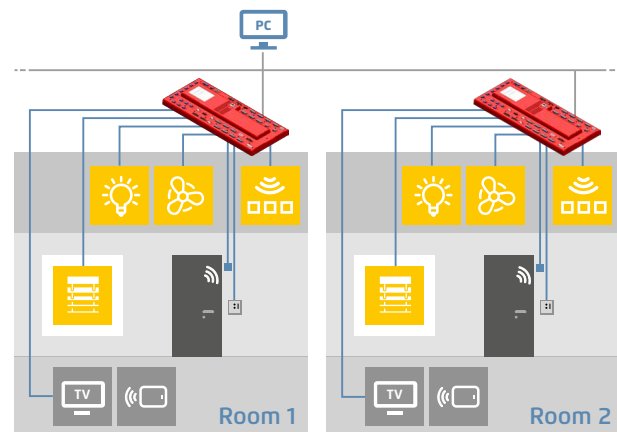

Example of a room box for hotel rooms:
Fully pre-assembled, easy commissioning and replaceable if defective.

Networked room automation

Full networking of all plants and services is increasingly required. One example of application is that the cooling requirement (HVAC service) in summer can be reduced with controlled blinds (electrical plant). All plants also only require a single control unit rather than several different devices. A web-based control concept can be created using Saia PCD including Web + IT functionalities. This can be used subsequently for commissioning, operation and service.

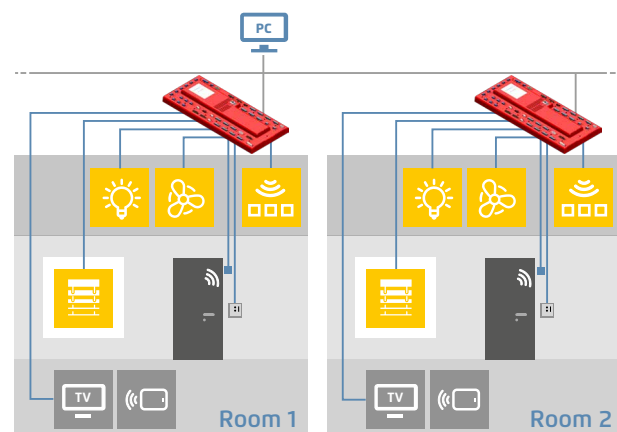

For example the operation of a conference room:
Each browser and every mobile device can now serve as a control station. Each room is thereby represented accurately and shows each user group only what it requires.



Annex

C1	Status: Product launch and availability	247
C2	Abbreviations	251
C3	Type Index	253

C1 Product information

Product status: Product launch and availability

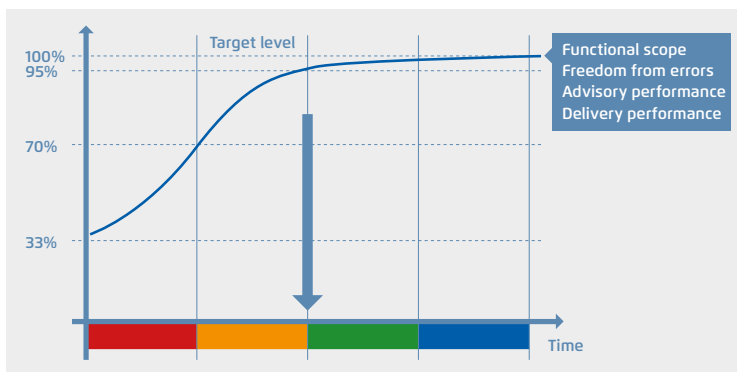

Natural learning curve when introducing products into manufacturing, logistics, support, documentation and function

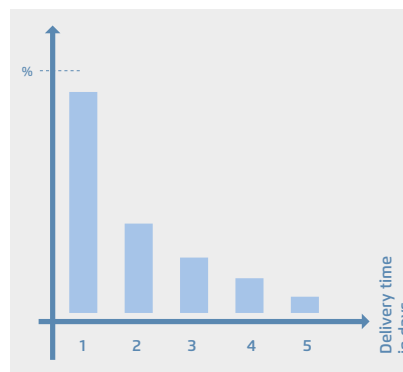

Target delivery performance
 – 80 % of deliveries in 2 working days
 – 95 % of deliveries in < 1 week
 – On-time delivery > 98.5 %

Release status of products

Product maturation is an evolutionary process and follows a maturation and learning curve. It starts with a product idea, which many people and divisions within the company then work on for a long time to reach all the new product’s various targets. These targets represent the function and design of the product. The manufacturer’s performance and quality standards must also be achieved.

At Saia Burgess Controls the product maturation process is represented with colour codes. These are described in the table below. These colour codes are used on a dedicated web-page: <http://sbc.do/We6uKnmS>. They document the actual status of all products currently in field trials or market launch. Please consult the web-page if you wish to use a product marked in this catalogue as „* Not released at time of printing“.

Meaning of product status colour codes

	Function/design	Logistics/availability	Support
Blue	Series production improvements have been incorporated. Final polish applied to design and function.	Product quantities have reached target volume and flow smoothly even when demand surges.	Training for product is standardized. Online support and FAQs established.
Green	Products are available in series production quality and may be used with no particular technical constraints or risks.	Unrestricted sale. Products from our own production are available ex stock. Shipping volume is on the rise.	All SBC sales and support organizations have the necessary product skills. Its use can be fully supported.
Orange	Products are available in series production quality. In the pilot phase, any deficits of function or design are found and corrected.	Products for ‘restricted’ sale. Delivery not yet ex stock. Quantity limited. Customers are informed about pilot status of product.	Product is known throughout organization. Support capability is still limited to a few individuals.
Red	Laboratory and functional models are available for laboratory and field trials. Not for sale. Not for use in customer production setting.	No product orders accepted. Scheduling in a new key project may well be possible. Inquire about delivery dates!	Developers and product managers advise on function and look after laboratory and field trials.

Switch from paper to QR-Codes

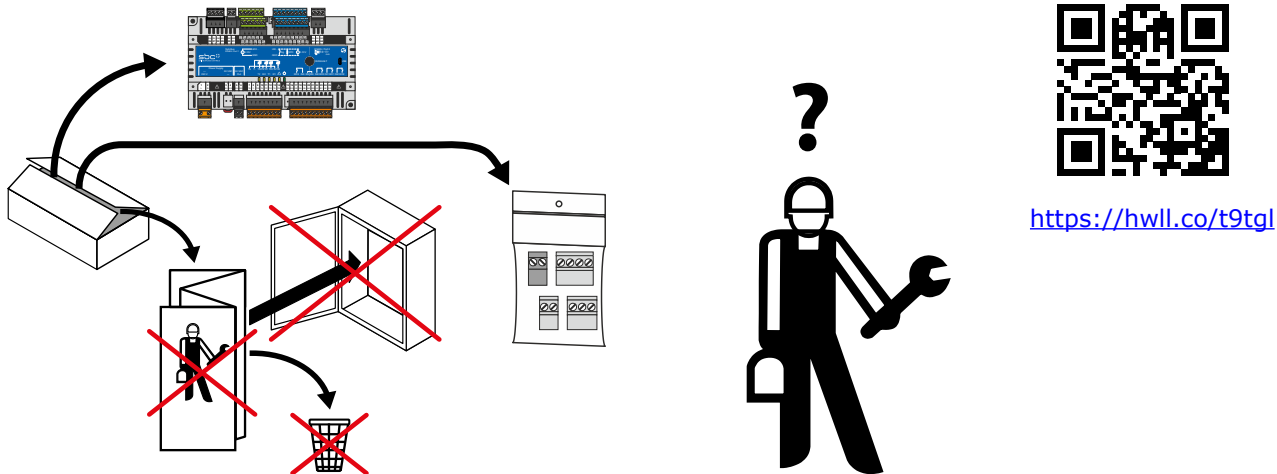

As we transition our business to become more eco-friendly, we continue to look for opportunities to reduce printed materials where possible.

One area that we have been looking at is the reduction in printed installation instructions, data sheets and manuals that are included with our products – many of which end up in waste never having been used, creating an unnecessary and significant impact on our environment.

We are informing you that we will no longer include printed installation instructions or data sheets with our manufactured products, instead replacing them with a QR code on both the product and outer box labels for easy lookup, should your installers need them. Going forward we will look to extend this to all other products we supply.

The use of QR codes is very simple – just align your phone camera with the QR code and a pop-up notification will provide a link to the product landing page, where you can select the language and the manual needed.

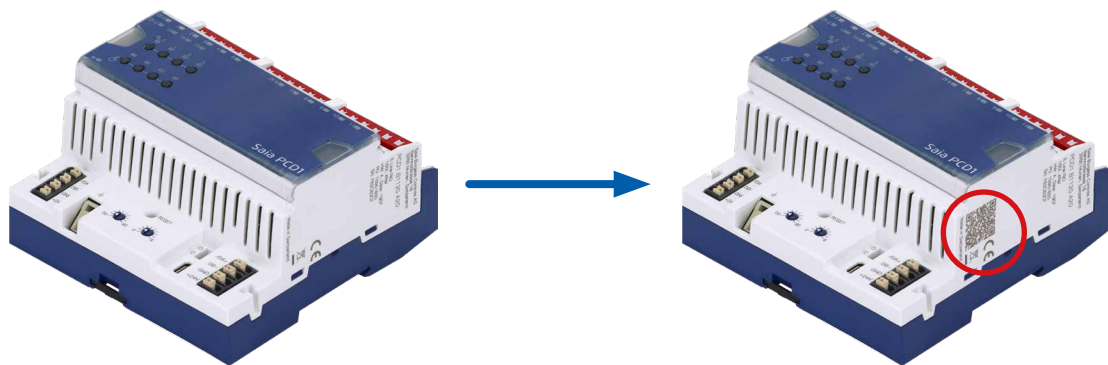

3D-data

Our targets:

- ▶ Supply 3D-data with the format STEP (.stp- or .step-files) and Autodesk Revit (.rfa-files)
- ▶ Other data formats are also provided if available
- ▶ The objects are neither suitable for the design nor for the production. They are only designed as placeholders for the planning of facilities and trades
- ▶ Accordingly, the objects are simplified, not complete and have only limited dimensional accuracy (height, width and depth).

STEP-files

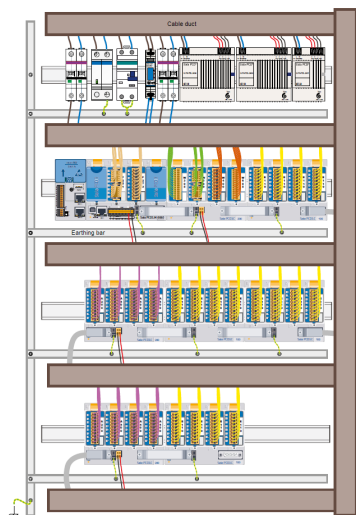

Files in STEP 3D model format are identified by the STEP extension. If you want to open a STEP file (STP), you can do so with a variety of programs. This format is a standard that allows three-dimensional graphics to be displayed in a variety of applications.

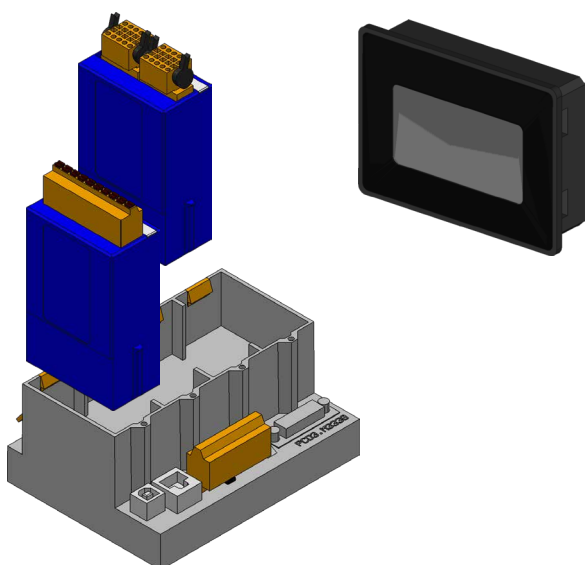

BIM-objects

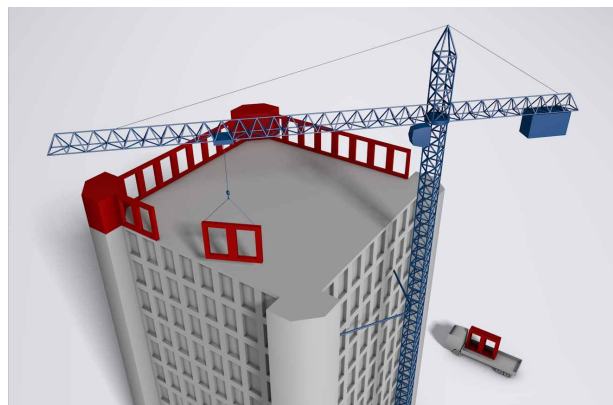

Building information modelling (BIM) is a process involving the generation and management of digital representations of physical and functional characteristics of the built environment. Building Information Modelling is used both in the building industry for construction planning and execution (architecture, engineering, building services) and in facility management.

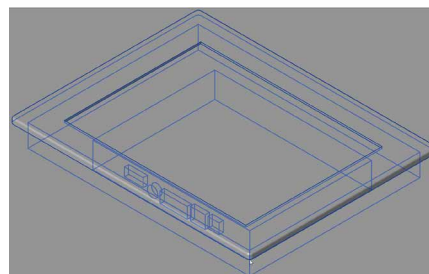

The files are provided free of charge and can be downloaded from our support web page using the following link:
<https://sbc-support.com/en/services/bim-building-information-model/>

Abbreviation	Written out / Explanation
3G	Third generation of mobile telecommunications technology
ADSL	Asymmetric digital subscriber line (ADSL)
ASCII	The American Standard Code for Information Interchange, is a 7 bit character-encoding scheme
CCFL	Cold cathode fluorescent lamp (CCFL) are used for backlighting of LCDs, for example computer monitors and television screens
CGI	Common Gateway Interface (CGI) is a standard method used to generate dynamic content on Web pages and Web applications
CO₂ / CO₂	Carbon dioxide (chemical formula CO ₂) is a naturally occurring chemical compound composed of 2 oxygen atoms each covalently double bonded to a single carbon atom.
COB	A Saia PCD program is a tree-like structure of organization blocks which contain the application's code. Each block provides a particular service: cyclical programming (COB), sequential programming (SB), sub-programs (PB), functions with parameters (FB), and exception routines (XOB)
CPU	A central processing unit (CPU) is the electronic circuitry within a computer that carries out the instructions of a computer program by performing the basic arithmetic
CSV	A comma-separated values (CSV) (also sometimes called character-separated values, because the separator character does not have to be a comma) file stores tabular data (numbers and text) in plain-text form
DHCP	The Dynamic Host Configuration Protocol (DHCP) is a standardized network protocol used on Internet Protocol (IP) networks for dynamically distributing network configuration parameters, such as IP addresses for interfaces and services
DIN	Deutsches Institut für Normung e.V. (DIN; in English, the German Institute for Standardization) is the German national organization for standardization and is the German ISO member body
DSL	Digital subscriber line (DSL; originally digital subscriber loop) is a family of technologies that provide internet access by transmitting digital data using a local telephone network which uses the public switched telephone network
DTMF	Dual-tone multi-frequency signaling (DTMF) is used for telecommunication signaling over analog telephone lines in the voice-frequency band between telephone handsets and other communications devices and the switching center
FB	A Saia PCD program is a tree-like structure of organization blocks which contain the application's code. Each block provides a particular service: cyclical programming (COB), sequential programming (SB), sub-programs (PB), functions with parameters (FB), and exception routines (XOB)
FBox	The graphical function boxes (FBoxes) have inputs and outputs, and can also have configurable properties using parameter windows which can also be modified online. Around 250 FBoxes are already provided in the basic PG5 package. The range of functions goes far beyond the normal binary and arithmetic functions.
EHA	Exhaust air
FTP	The File Transfer Protocol (FTP) is a standard network protocol used to transfer computer files from one host to another host over a TCP-based network, such as the Internet
FUPLA	FUPLA is SBC's own function block diagram editor
FW	Firmware
BA	Building Automation
BMS	Building management system
HVAC	HVAC (heating, ventilating, and air conditioning) is the technology of indoor and vehicular environmental comfort
HVACSE	Heating, ventilating, air conditioning, sanitary and electric
HMI	Human Machine Interface
HP	A horizontal pitch, short HP, is a unit of measurement to describe the width of assemblies. Electrical installation switchboards corresponds a HP to 17,5 mm according to DIN 43880
HTML	HTML or HyperText Markup Language is the standard markup language used to create Web pages
HTTP	The Hypertext Transfer Protocol (HTTP) is an application protocol for distributed, collaborative, hypermedia information systems
HW	Hardware
ICA technology	Instrumentation, Control and Automation technology
IL	Instruction List

Abbreviation Written out / Explanation

IR	Infrared
LD	Ladder diagram a method of drawing electrical logic schematics. A ladder diagram represents a program in ladder logic
MB	The Micro-Browser application allows the visualization and operation of web projects which have been created with Saia PG5® Web Editor
MID	Measurement Instrument Directive
MTBF	Mean time between failure
OEM	Original equipment manufacturer (OEM) is a term used when one company makes a part or subsystem that is used in another company's end product
OPC	OLE for Process Control (OPC), which stands for Object Linking and Embedding (OLE) for Process Control. The standard specifies the communication of real-time plant data between control devices from different manufacturers
PB	A Saia PCD program is a tree-like structure of organization blocks which contain the application's code. Each block provides a particular service: cyclical programming (COB), sequential programming (SB), sub-programs (PB), functions with parameters (FB), and exception routines (XOB)
PGU	ProGramming Unit This term designates the programming console, but also by extension the port where the console must be connected. The PGU designates also the protocol used by the programming console.
RC-bus	Internal data bus to connect digital room control devices or extension modules (Remote Control Bus)
RIO	Remote Inout/Output
RTU	Remote Terminal Unit or Remote Telemetry Unit, a microprocessor controlled electronic device
SCADA	Supervisory Control and Data Acquisition
S-IO	The S-IO protocol supports the operation of SBC remote I/O stations
SMTP	Simple Mail Transfer Protocol (SMTP) is an Internet standard for electronic mail (e-mail) transmission
SNMP	Simple Network Management Protocol (SNMP) is an „Internet-standard protocol for managing devices on IP networks“.
SNTP	Is known as the Simple Network Time Protocol (SNTP). It is used in some embedded devices and in applications where high accuracy timing is not required
PLC	A programmable logic controller, PLC or programmable controller is a digital computer used for automation of typically industrial electromechanical processes, such as control of machinery on factory assembly lines, amusement rides, or light fixtures
SRC	Single Room Controller
STN	A super-twisted nematic display (STN) is a type of monochrome passive-matrix liquid crystal display (LCD)
SUP	Supply air
SW	Software
TCP/IP	The Internet protocol suite is the computer networking model and set of communications protocols used on the Internet and similar computer networks. It is commonly known as TCP/IP, because its most important protocols, the Transmission Control Protocol (TCP) and the Internet Protocol (IP)
TFT	A thin-film-transistor liquid-crystal display (TFT LCD) is a variant of a liquid-crystal display (LCD) that uses thin-film transistor (TFT) technology to improve image qualities such as addressability and contrast
URL	A uniform resource locator (abbreviated URL; also known as a web address, particularly when used with HTTP) is a specific character string that constitutes a reference to a resource
VAV	Variable Air Volume (VAV) is a type of heating, ventilating, and/or air-conditioning (HVAC) system
VOC	Volatile Organic Compounds
VPN	A virtual private network (VPN) extends a private network across a public network, such as the Internet
WAN	A wide area network (WAN) is a network that covers a broad area (i.e., any telecommunications network that links across metropolitan, regional, national or international boundaries) using leased telecommunication lines
XOB	A Saia PCD program is a tree-like structure of organization blocks which contain the application's code. Each block provides a particular service: cyclical programming (COB), sequential programming (SB), sub-programs (PB), functions with parameters (FB), and exception routines (XOB)

Sources: our manuals and www.wikipedia.org

C3 Type Index

Article	Weight [g]	Catalogue page
32304321-003-S	40	82
32309178-001	24	95
32309178-002	36	95
410474200	1	127
410474850	4	127
410474930	10	33
410475150	8	33
410477190	187	57
431087230	98	32, 32
440548470	17	57
440549160	20	57
440549170	20	57
440549180	20	57
440549190	20	57, 63, 135
440549340	8	33
440549360	11	33
440549520	15	33
440549540	15	33
440549560	16	33
440549950	12	33
440549980	13	33
440550480	6	33, 57
440550540	9	57
440550870	8	63, 67, 135
440550880	9	71, 75, 151
440550890	10	71, 75, 151
450748170	3	33, 55, 57, 63, 67, 135
463948980	10	33, 47, 55, 57

Article	Weight [g]	Catalogue Page
AAE1D5F10KR3A00	128	126
ALD1B5FD00A3A00	80	120, 125
ALD1B5FS00A3A00	95	120, 123
ALD1D5F10KA3A00	87	120, 126
ALD1D5FD00A3A00	80	120, 125
ALD1D5FD00A3A44	80	125
ALD1D5FM00A3A00	96	120, 124
ALD1D5FS00A3A00	78	120, 123
ALE3B5F10KC3A00	213	120, 126
ALE3B5FD00C3A00	228	120, 125
ALE3B5FM00C3A00	188	120, 124
ALE3B5FS00C3A00	228	120, 123
ALE3D5F11KC3A00	217	120, 126
ALE3D5FD10C3A00	230	120, 125
ALE3D5FD10C3A44	230	125
ALE3D5FM10C3A00	224	120, 124
ALE3D5FS10C3A00	230	120, 123
AWD3B5W10MC3A00	217	120, 126
AWD3B5WS00C3A00	190	120, 123
AWD3D5W10MC3A00	216	120, 126
AWD3D5WD00C3A00	224	120, 125
AWD3D5WD00C3A44	224	125
AWD3D5WM00C3A00	221	120, 124
AWD3D5WS00C3A00	226	120, 123
BACA-A	120	109, 114, 116
IRM-RLC	62	105, 107, 114, 116
IRM-RSC	55	105, 107, 114, 116

Article	Weight [g]	Catalogue Page
PCD1.A1000-A20	210	82
PCD1.A2000-A20	270	82
PCD1.B1000-A20	385	82
PCD1.B1010-A20	385	82
PCD1.B1020-A20	353	82
PCD1.B1100-A20	360	82
PCD1.B1120-A20	330	82
PCD1.B5000-A20	220	82
PCD1.B5010-A20	220	82
PCD1.E1000-A10	180	82
PCD1.F2611-C15	129	69, 79, 179, 191, 224
PCD1.G1100-C15	140	69, 77, 179, 191, 224
PCD1.G2000-A20	210	80, 82
PCD1.G2100-A10	210	80, 82
PCD1.G2200-A20	220	80, 82
PCD1.G5000-A20	389	80, 82
PCD1.G5010-A20	362	80, 82
PCD1.G5020-A20	360	80, 82
PCD1.K0206-005	365	82
PCD1.K0206-025	365	82
PCD1.M0160E0	300	61, 65, 130, 132, 179, 190, 205, 206, 208, 214
PCD1.M2110R1	450	35, 36, 64, 135, 190, 212, 214
PCD1.M2120	400	35, 36, 60, 135, 190, 211, 212, 214, 223
PCD1.M2160	400	35, 36, 60, 112, 129, 135, 190, 212, 214, 223, 225
PCD1.M2220-C15	550	14, 73, 112, 135, 155, 190, 206, 214, 240, 241
PCD1.W5200-A20	220	80, 82
PCD1.W5300-C15	120	69, 78, 191
PCD2.A200	60	52
PCD2.A220	60	52
PCD2.A250	60	52
PCD2.A400	40	52
PCD2.A410	40	52

Article	Weight [g]	Catalogue Page
PCD2.A460	40	52
PCD2.A465	30	52
PCD2.B100	45	52
PCD2.B160	50	52
PCD2.C1000	500	47, 50, 52
PCD2.C2000	1040	47, 50, 52
PCD2.E110	35	52
PCD2.E111	35	52
PCD2.E160	40	52
PCD2.E161	40	652
PCD2.E165	40	52
PCD2.E166	40	52
PCD2.E610	40	52
PCD2.F2100	60	54, 62, 66, 74, 190, 214
PCD2.F2150	60	54, 62, 66, 67, 74, 111, 190, 191, 216
PCD2.F2210	60	54, 62, 66, 74, 190, 214
PCD2.F2610	40	54, 62, 64, 66, 74, 190, 212
PCD2.F2700	40	54, 62, 66, 74, 190, 211
PCD2.F2710	40	54, 62, 66, 74, 190, 211
PCD2.F2720	40	54, 62, 66, 74, 190, 211
PCD2.F2810	60	54, 62, 66, 74, 190, 211, 214
PCD2.G200	80	53
PCD2.H112	24	52
PCD2.H114	27	52
PCD2.K010	40	50, 57
PCD2.K106	100	50, 57
PCD2.K221	240	33, 57, 150
PCD2.K223	330	33, 57, 150
PCD2.K231	140	33, 57, 150
PCD2.K232	220	33, 57, 150
PCD2.K241	120	33, 57, 150
PCD2.K242	200	33, 57, 150

Article	Weight [g]	Catalogue Page
PCD2.K520	150	33, 57, 151
PCD2.K521	250	33, 57, 151
PCD2.K525	280	33, 57, 151
PCD2.K551	340	33, 57, 151
PCD2.K552	400	33, 57, 151
PCD2.M4160	890	36, 46, 52, 57, 73, 112, 155, 179, 190, 191, 205, 206, 212, 214
PCD2.M4560	920	36, 46, 52, 57, 73, 112, 155, 179, 190, 191, 205, 206, 212, 214
PCD2.M5540	1460	14, 15, 18, 35, 48, 52, 57, 74, 155, 179, 190, 191, 192, 197, 205, 206, 208, 211, 212, 214, 222, 224
PCD2.W200	35	53
PCD2.W210	35	53
PCD2.W220	40	53
PCD2.W300	40	53
PCD2.W310	40	53
PCD2.W315	45	53
PCD2.W340	40	53
PCD2.W350	40	53
PCD2.W360	40	53
PCD2.W380	40	53
PCD2.W400	40	53
PCD2.W410	45	53
PCD2.W525	50	53
PCD2.W600	40	53
PCD2.W605	45	53
PCD2.W610	45	53
PCD2.W615	45	53
PCD2.W745	40	53
PCD3.A200	100	26
PCD3.A210	120	26
PCD3.A220	100	26
PCD3.A251	120	26
PCD3.A300	100	26

Article	Weight [g]	Catalogue Page
PCD3.A400	100	26
PCD3.A410	100	26
PCD3.A460	80	26
PCD3.A465	80	26
PCD3.A810	100	26
PCD3.B100	100	26
PCD3.B160	100	26
PCD3.C100	420	21, 28, 34
PCD3.C110	260	21, 28, 34
PCD3.C200	440	21, 26, 27, 28, 34
PCD3.E009	40	33
PCD3.E110	80	26
PCD3.E111	80	26
PCD3.E160	80	26
PCD3.E161	80	26
PCD3.E165	80	26
PCD3.E166	80	26
PCD3.E610	80	26
PCD3.F110	100	23, 24, 29, 30, 36, 42, 44, 190
PCD3.F121	100	23, 24, 29, 30, 36, 42, 44, 190
PCD3.F150	100	23, 24, 29, 30, 36, 42, 44, 111, 190
PCD3.F180	100	23, 24, 29, 30, 36, 42, 44, 190
PCD3.F210	100	23, 24, 29, 30, 36, 42, 190
PCD3.F215	100	23, 24, 29, 30, 42, 190, 191, 206
PCD3.F221	100	23, 24, 29, 30, 42, 190
PCD3.F261	100	23, 24, 29, 30, 36, 42, 44, 190, 212
PCD3.F270	80	23, 24, 29, 30, 36, 42, 44, 190, 211
PCD3.F271	80	23, 24, 29, 30, 36, 42, 44, 190, 211
PCD3.F272	80	23, 24, 29, 30, 36, 42, 44, 190, 211
PCD3.F281	100	23, 24, 29, 30, 42, 190, 214
PCD3.H112	80	20, 26, 29, 36, 44
PCD3.H114	100	20, 26, 29, 36, 44

Article	Weight [g]	Catalogue Page
PCD3.K010	40	21, 28, 34
PCD3.K106	140	21, 28
PCD3.K116	180	21, 28
PCD3.M3160	640	14, 15, 18, 20, 24, 26, 27, 33, 35, 36, 74, 112, 129, 130, 155, 179, 190, 191, 205, 206, 207, 212, 223, 224, 225, 226
PCD3.M3360	640	14, 15, 18, 20, 24, 26, 27, 33, 35, 36, 74, 112, 129, 130, 155, 179, 190, 191, 205, 206, 207, 212, 223, 224, 225, 226
PCD3.M5360	800	14, 15, 18, 20, 22, 23, 26, 27, 33, 35, 36, 74, 112, 129, 130, 155, 179, 190, 191, 192, 197, 205, 206, 207, 212, 222, 224, 225, 226
PCD3.M5560	820	14, 15, 18, 20, 22, 23, 26, 27, 28, 33, 35, 36, 74, 112, 129, 130, 155, 179, 190, 191, 192, 197, 205, 206, 207, 212, 221, 222, 224, 225, 226
PCD3.M6860	820	14, 15, 20, 22, 23, 26, 27, 33, 35, 36, 74, 112, 129, 130, 155, 179, 190, 191, 201, 202, 205, 206, 207, 212, 224, 225, 226
PCD3.M6880	820	38, 39, 41, 42, 112, 179, 190, 191, 205, 206, 207, 212
PCD3.R010	60	33
PCD3.R562	80	31, 35, 111, 191, 206, 207
PCD3.R600	80	31, 35, 231
PCD3.S100	180	---
PCD3.T665	460	22, 34, 36, 48, 60, 158, 190, 200, 201
PCD3.T666	480	22, 34, 36, 48, 60, 158, 190, 200, 201, 212, 213
PCD3.T668	480	38, 39, 43, 190
PCD3.W200	100	27
PCD3.W210	80	27
PCD3.W220	80	27
PCD3.W300	100	27
PCD3.W305	100	27
PCD3.W310	80	27
PCD3.W315	100	27
PCD3.W325	100	27
PCD3.W340	80	27
PCD3.W350	80	27
PCD3.W360	80	27
PCD3.W380	80	27
PCD3.W400	80	27
PCD3.W410	100	27

Article	Weight [g]	Catalogue Page
PCD3.W525	100	27
PCD3.W600	80	27
PCD3.W605	80	27
PCD3.W610	100	27
PCD3.W615	100	27
PCD3.W625	100	27
PCD3.W745	100	27
PCD3.W800	80	27
PCD7.D410-IWS	850	94
PCD7.D410-OWS	1300	94
PCD7.D410VT5F	2000	36, 91, 190, 206
PCD7.D410VT5Z11	2000	95
PCD7.D410VTCF	2000	89
PCD7.D410VTCZ11	2000	95
PCD7.D412DT5F	2700	36, 91, 190, 206
PCD7.D412DT5Z11	2700	95
PCD7.D412DTPF	2700	89
PCD7.D412DTPZ11	2700	95
PCD7.D412-IWS	1200	94
PCD7.D412-OWS	1600	94
PCD7.D443WT5R	250	93, 240, 242, 244
PCD7.D443WT5RW	250	93, 240, 242
PCD7.D443WTPR	250	93, 240, 242
PCD7.D443WTPRW	250	93, 240, 242
PCD7.D450WTPF	475	89, 95
PCD7.D450WTPZ11	475	95
PCD7.D457-IWS2	1500	94
PCD7.D457-OWS	2420	95
PCD7.D457-OWS1	1500	95
PCD7.D457-OWS2	1500	94
PCD7.D470WTPF	750	89
PCD7.D470WTPZ11	750	95
PCD7.D543RF	400	99

Article	Weight [g]	Catalogue Page
PCD7.D570CF1	1500	99
PCD7.D570RF	875	99
PCD7.D510CF1	2500	100
PCD7.D515CF1	4100	100
PCD7.D521CF1	6100	100
PCD7.F110S	7	30, 46, 47, 48, 54, 55, 61, 62, 64, 65, 66, 74, 90, 91, 111, 135, 190
PCD7.F121S	7	30, 46, 47, 48, 54, 55, 61, 62, 64, 65, 66, 74, 90, 91, 135, 190
PCD7.F150S	7	30, 46, 47, 48, 54, 55, 61, 62, 64, 65, 66, 74, 90, 91, 135, 190
PCD7.F180S	7	30, 46, 47, 48, 54, 55, 61, 62, 64, 65, 66, 74, 90, 91, 135, 190, 214
PCD7.H104D	180	126, 136
PCD7.H104DZ44	180	126, 136
PCD7.H104SE	183	126, 128, 130, 136
PCD7.K840	60	145, 199
PCD7.L252	100	67, 149
PCD7.L290	25	149
PCD7.L291	25	149
PCD7.L452	250	149
PCD7.L490	20	149
PCD7.L-RoomUP	---	110, 111, 114
PCD7.LRL2	1005	109, 111, 114, 115, 240, 241, 242
PCD7.LRL2-P5	1055	105, 240, 241, 242
PCD7.LRL4-P5	1055	105, 106, 240, 241, 242
PCD7.LRL5-P5	645	105, 240, 241, 242, 244
PCD7.LRS4	930	109, 114, 115, 240, 241, 242, 244
PCD7.LRS4-P5	975	105, 106, 240, 241, 242
PCD7.LRS5	525	109, 114, 240, 241, 242
PCD7.LRS5-P5	565	105, 240, 241, 242
PCD7.LR-TR40	120	107, 116
PCD7.LR-TR40-CO2	145	107, 116
PCD7.LR-TR40-H	135	107, 116
PCD7.LR-TR40-H-CO2	155	107, 116
PCD7.LR-TR42	135	107, 116, 244

Article	Weight [g]	Catalogue Page
PCD7.LR-TR42-CO2	155	107, 116, 244
PCD7.LR-TR42-H	135	107, 116
PCD7.LR-TR42-H-CO2	155	107, 116
PCD7.R562	10	9, 16, 31, 35, 46, 55, 62, 66, 67, 74, 91, 111, 135, 191, 206, 207, 223, 224, 225, 231
PCD7.R610	9	9, 16, 31, 35, 46, 55, 62, 66, 74, 91, 133, 135, 231
PCD7.R-MSD1024	10	16, 31, 35, 55, 62, 66, 74, 91, 133, 135, 231
PCD7.R-SD1024	10	16, 31, 35, 223, 224, 225, 231
PCD7.R-SD512	10	16, 31, 35, 223, 224, 225, 231
PCD7.T161	80	108, 127, 147
PCD7.T162	80	108, 127, 147
PCD7.W600	10	61, 65, 135
PCD8.BACnet-Eye-1	---	186
PCD8.OPC-1	300	185
PCD8.OPC-3	300	185
PCD8.OPC-5	300	185
PCD8.PG5-CORE	300	171
PCD8.PG5-DEMO	400	171
PCD8.PG5-ENDUSER	400	171
PCD8.PG5-EXTENDED	400	171
PCD8.PG5-FBOXBLD	---	171
PCD8.PG5-HVAC	400	171
PCD8.PG5-UPGRADE	400	171
PCD8.PG5-UPGR-EXTD	400	171
PCD8.PG5-UPGR-HVAC	400	171
PCD8.SUP-500	---	181
PCD8.SUP-2500	---	181
PCD8.SUP-10000	---	181
PCD8.SUP-25000	---	181
PCD8.SUP-50000	---	181
PCD8.SUP-100000	---	181
PCD8.SUP-100EXT	---	181
PCD8.SUP-2500EXT	---	181
PCD8.SUP-5000EXT	---	181

Article	Weight [g]	Catalogue Page
PCD8.SUP-15000EXT	---	181
PCD8.SUP-50000EXT	---	181
PCD8.SUP-500OPEN	---	181
PCD8.SUP-2500OPEN	---	181
PCD8.SUP-5000OPEN	---	181
PCD8.SUP-5000OPEN	---	181
PCD8.SUP-25000OPEN	---	181
PCD8.SUP-50000OPEN	---	181
PCD8.SUP-MNT1	---	181
PCD8.SUP-MNT3	---	181
PCD8.SUP-MNT5	---	181
PCD8.SUP-1N-UP	---	181
PCD8.SUP-10N-UP	---	181
PCD8.SUP-DB-CSV	---	181
PCD8.SUP-DB-MYSQL	---	181
PCD8.SUP-DB-ORCL	---	181
PCD8.SUP-DB-SQL	---	181
PCD8.SUP-JSON	---	181
PCD8.SUP-FID	---	181
PCD8.SUP-MLS-16	---	181
PCD8.SUP-MLS-64	---	181
PCD8.SUP-MAXP-16	---	181
PCD8.SUP-MAXP-64	---	181
PCD8.SUP-MAXP-128	---	181
PCD8.SUP-AXIS-16	---	181
PCD8.SUP-AXIS-64	---	181
PCD8.SUP-EM25	---	181
PCD8.SUP-EM50EXT	---	181
PCD8.SUP-EM100EXT	---	181
PCD8.SUP-EM500EXT	---	181
PCD8.SUP-EM1KEXT	---	181
PCD8.SUP-NA-250	---	181
PCD8.SUP-NA-1000	---	181

Article	Weight [g]	Catalogue Page
PCD8.SUP-NA-10000	---	181
PCD8.SUP-LDAP	---	181
PCD8.SUP-ESIG-1000	---	181
PCD8.SUP-ESIG-UNL	---	181
PCD8.SUP-ESIG-UP1K	---	181
PCD8.SUP-CLO-500	---	181
PCD8.SUP-CLO-2500	---	181
PCD8.SUP-CLO-10000	---	181
PCD8.SUP-HTTP	---	181
PCD8.SUP-NAA-MON	---	181
PCD8.SUP-NAA-STK1	---	181
PCD8.SUP-NAA-STK5	---	181
PCD8.SUP-NAA-REN	---	181
PCD8.SUP-NAA-ENG	---	181
PMK-EEM400	---	127
Q.NET-5TX	230	35, 146
Q.NET-8TX	270	35, 146
Q.NET-CON	---	145, 199
Q.NET-EBW-E100	130	145, 199
Q.NET-EBW-H100	135	145, 199
Q.PS-AD1-2403	200	139
Q.PS-AD2-2402F	300	139
Q.PS-AD2-2405F	600	139
Q.PS-AD2-2410F	600	139
Q.PS-ADB-2405-1	700	139
Q.PS-PEL-2401	300	83, 142
Q.PS-PEL-2403	330	83, 142
T7460A1001	120	109, 114, 116
T7460B1009	140	109, 114, 116
T7460C1007	155	109, 114, 116
T7460D1005	155	109, 114, 116
T7460F1000	160	109, 114, 116

Notes



Imprint Publisher

Saia-Burgess Controls AG
Route Jo-Siffert 4 | 1762 Givisiez, Switzerland
T +41 26 580 30 00 | F +41 26 580 34 99
www.saia-pcd.com | info@saia-pcd.com

Subject to change without notice. The latest version is available at: www.sbc-support.com

Saia-Burgess Controls AG

Route Jo-Siffert 4
1762 Givisiez, Switzerland

T +41 26 580 30 00

F +41 26 580 34 99

www.saia-pcd.com
info@saia-pcd.com

26-215 ENG18d

system

Catalogue

2022 | 2023

SAIA

BORG

SAIA BURGESS CONTROLS