

# PCD7.D1000

## Wall Unit

Wall unit for room temperature measurement, set point offset control. The design is in line with the PEHA Dialog Aluminium wall switch portfolio.

The wall unit is connected to a Saia PCD® by a RJ9 cable including 24 VDC power supply and bus communication. It is controlled via the RS-485 serial communication protocol S-Bus. Data points can be read and written from the controller via S-Bus and Modbus Registers, a complete documentation is available from this data sheet.

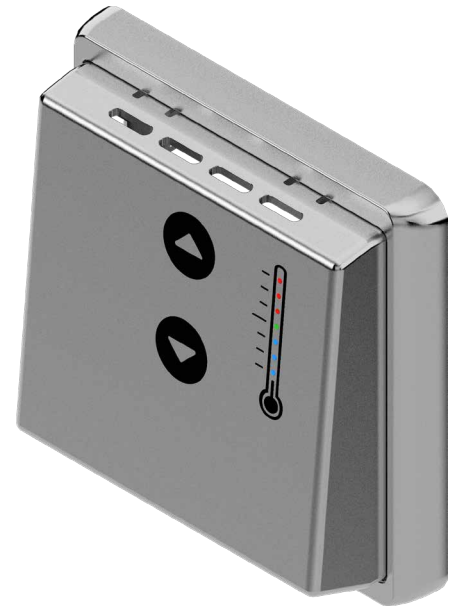

### Features

- Design according PEHA Dialog Aluminium
- Room temperature sensor 0...40°C
- Set point offset control  $\pm 3$  K in steps of 0.5 K
- 7 LED for signalization of set point offset
- 2 Pluggable RJ9 connectors for daisy chain up to 6 wall units
- S-Bus / Modbus protocol for data exchange with Saia PCD® Systems

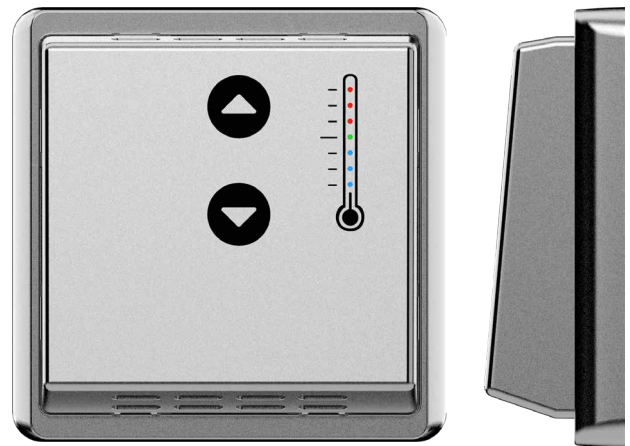

### General technical data

#### Power supply

Supply voltage	24 VDC, -15/+20%
Power consumption	120 mW

#### Interfaces

Communications interface	RS-485 Baud rate: 9,600, 19,200, 38,400, 57,600, 115,200 bps (Autobauding)
Address setup	By default address 1, service button for address setup in a range of 0 ... 98
Bus termination	Not included

#### General data

Ambient temperature	Operation: 0 ... +55°C Storage: -40 ... +70°C
Protection class	IP 30

### Mounting plate

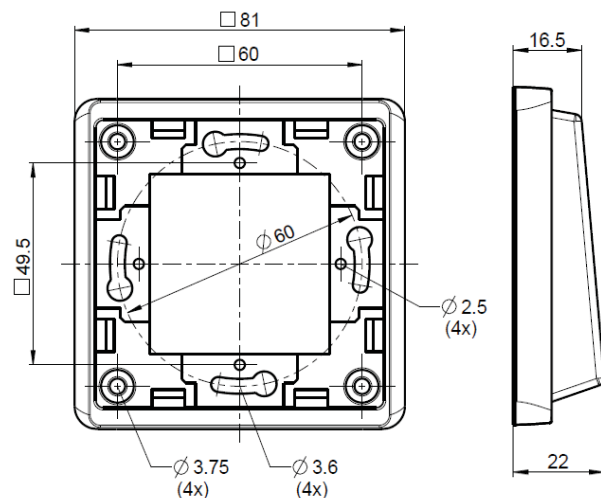

Screws shall be tighten in maximum with 0.6 Nm

The room panel is compatible with the PEHA Dialog design program. It is to be mounted with a dedicated single frame, included in the delivery package and can be combined with any electrical installation material from the same program. For more information about [Dialog](#) please check out the [PEHA homepage](#).

## Technical data

Room temperature sensor	0...40°C, resolution 0.1 K
Temperature offset	± 3 K in steps of 0.5 K
Buttons	Capacitive push buttons for temperature offset up and down
LEDs	3 red, 1 green, 3 blue

## Status LED

All LEDs off	No Power
At least one LED on	In operation
Green blink	Commissioning mode
3 red, green and 3 blue blinking	Booter mode, ready for firmware download
3 red, green and 3 blue blinking	Booter mode, device not operational, firmware error, firmware download required.

## Service button

Pushed at power up and released within max. 15 seconds: Module enters in Boot mode.

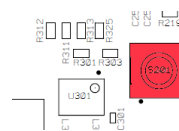

Pushed in operation at least 3 seconds and released: Commissioning mode

## Installation instructions

- For a safe use of the Wall Unit device:
  1. First, the device should be mounted on an inflexible and flat surface
  2. Second, once the frame is fixed to the wall, connect the RJ9 connector **without** the power on the PLC side. Then click the cover to its frame. This will insure a correct capacitive key detection level at power up
  3. As the capacitive keys are sensitive to their close environment, avoid any shock around the device under function

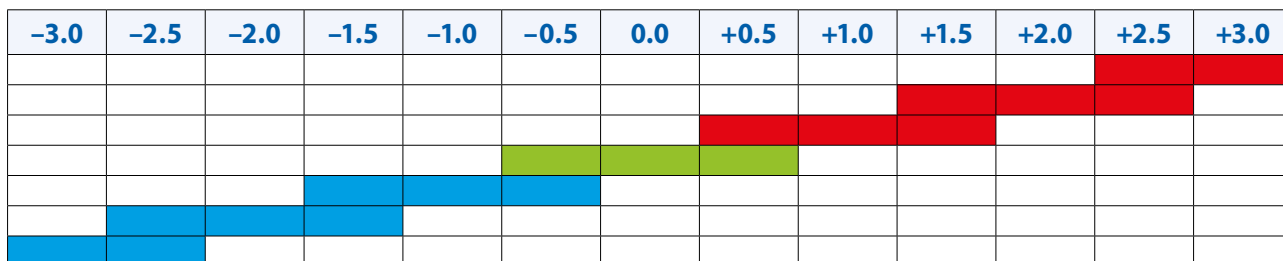

## Operation

The green LED signals the operation state. In normal operation at least one LED lights permanently. Actual values are provided by Registers to be polled by the communication master.

## Temperature measurement

The room temperature is detected in a range of 0...40°C and provided at a Register value with a resolution of a tenth of degree (23.5°C → 235 register value).

## Set point adjustment

The set point offset can be modified by 2 buttons up and down in six steps each. Three red LEDs signal a positive set point offset (0.5...3.0 K) and the three blue LEDs a negative offset (-0.5...-3.0 K). The offset is provided at a register value also with a resolution of 1/10. The set point offset value can also be remotely controlled over the communication protocol.

## LED brightness

The LED brightness can be controlled by register value as percentage in a range of 0 (total dark, off) up to full brightness (100.0%). The register value is given with a resolution of 1/10.

## Keys

"Do activate only one key at once"

## Connection diagram

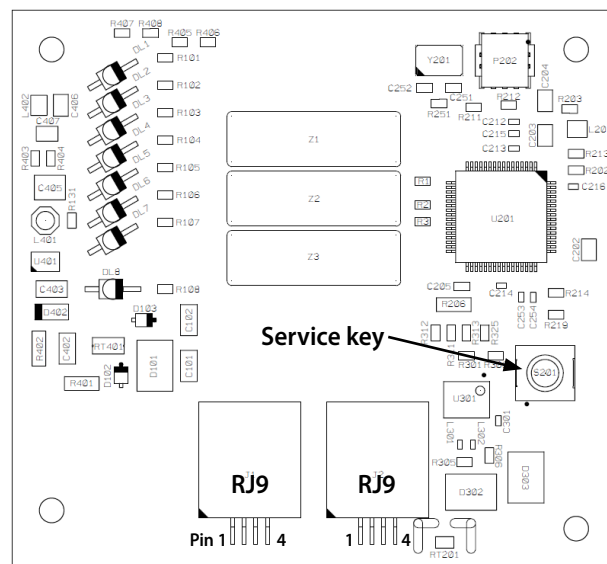

## RJ9 Connector

Pin 1	24 VDC	Pin 2	RS-485, /DA+
Pin 3	RS-485, DB	Pin 4	GND

## Connection information for use with PCD7.LRxx-P5 controllers

The PCD7.LRxx-P5 controller can provide the 24 VDC supply voltage for the PCD7.D1000 over the Sylkbus connector plug pin number 20 and 21:

- nr. 20 / WM1 → +24 VDC
- nr. 21 / WM2 → GND

## Commissioning

The room panel has by factory default a ready to use configuration and doesn't need any service procedure. The device address is set to 1 by production. After booting, the room unit detects the room temperature and sets the offset to 0.

For more than one room panel on the same serial line, it is required to set the device address. The address can be set remotely via S-Bus and Modbus communication in a range from 0 to 252. To enable the address setting mode, press the service key when the device is in operation at the back side for at least 3 seconds and release the button. The device enables a second address 253 for data communication for a timeout of 300 seconds. The timeout is refreshed with every valid data transfer via address 253. During this time the green LED is blinking (1s cycle 500 ms ON and 500 ms OFF). The address can be read and written from Register 100. The second address timeout can be read, set and reset (=0) from Register 101. When the address at Register 100 has changed it will be stored (none volatile) and activated immediately.

In case of any firmware errors, the device can be set in Boot mode. To enable the boot mode, unplug the module from power supply, press the service key and power on the device. The LEDs blink all together, release the button in maximum within 15 seconds. Otherwise the module starts in normal operation. The boot mode is active for 60 seconds to start a firmware download. Without any action, it quits after 60 seconds automatically and starts normal operation.

### S-Bus / Modbus configuration

The protocol can be set up in commissioning mode. As described above, push the service key for at least 3 seconds and release the button. The green LED is blinking (1 s cycle 500 ms ON and 500 ms OFF). Push the service key shortly 3 times within 2 seconds to enable the protocol set up mode. The LEDs at the front indicate the current protocol setting.

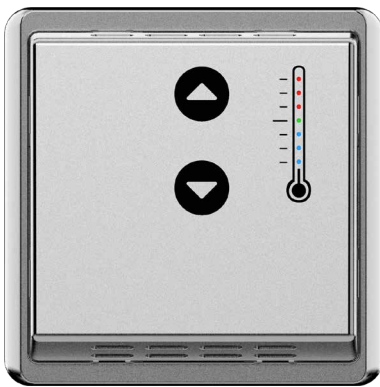

			Protocol Setting	Action
			S-Bus	Push the button "Up" for selecting the protocol
			Modbus 1 Stop-Bit	
			Modbus 2 Stop-Bit	
			Commissioning mode	
			Parity: None	Push the button "Down" to select the parity mode (only for Modbus)
			Parity: Even	
			Parity: Odd	

Without any action within 30 seconds, the protocol set up mode will be terminated automatically. Select the protocol by pressing the "Up" button. Parity can be adjusted for Modbus by pressing the "Down" button. To apply the setting press the service key again shortly. New settings are ignored when 30 seconds no further action was detected.

### S-Bus

SBus communication is based on Saia PCD® SBus Data Mode. The device address is by factory default adjusted to 1. The baud rate will be learned at start up from the network. By factory default it is set to 19200 Baud.

#### Factory default:

- ▶ Device address 1
- ▶ Baudrate 19200, auto baud detection
- ▶ Protocol S-Bus data mode
- ▶ Set point offset 0
- ▶ LED brightness 50%

The following table describes the media and parameter mapping to Registers for configuring.

#### Register Configuration

Parameter	Read/Write	Description
Register 0	R	Room temperature value 0 ... +40°C (register value 0 ... 400)
Register 1	R	Reserved
Register 2	R/W	Set point offset value ± 3K in steps of 0.5 K (register value -30 ... 0 ... +30)
Register 3	R/W	Reserved
Register 4	R/W	LED Brightness in a range of 0 ... 100% (register value 0 ... 1000)
Register 5	R	Temperature sensor value before load compensation 0 ... 40°C (register value 0 ... 400)
Register 100	R/W	Read and write S-Bus address for dynamic readdressing (0 ... 252)
Register 101	R/W	Secondary address (253) enable time out in seconds for commissioning, address set up
Register 102	R	Serial Number
Register 103	R	Firmware Version in Hex (BCD: 1.02.01 = 00010201 Hex)

## Modbus communication

Modbus communication can be set up in commissioning mode. Parity and number of Stop Bits can be chosen. The device address is by factory default adjusted to 1. The baud rate will be learned at start up from the network. By factory default it is set to 19200 Baud.

### Factory default:

- ▶ Device address 1
- ▶ Baudrate 19200, auto baud detection, data bit, no parity, 1 stop bit (8N1)
- ▶ Protocol S-Bus data mode, Modbus need to be set up in commissioning mode
- ▶ Set point offset 0
- ▶ LED brightness 50%



### Warning

Mounting the device under power or applying any kind of mechanical stress on the device or on the cable could result in a temporary key detection malfunction!

The following table describes the media and parameter mapping to Registers.

#### Register Configuration

Parameter	Read/Write	Description
Register 0	R	Room temperature value 0 ... +40°C (register value 0 ... 400)
Register 1	R	Reserved
Register 2	R/W	Set point offset value $\pm 3$ K in steps of 0.5 K (register value -30 ... 0 ... +30)
Register 3	R/W	Reserved
Register 4	R/W	LED Brightness in a range of 0 ... 100% (register value 0 ... 1000)
Register 5	R	Temperature sensor value before load compensation 0 ... 40°C (register value 0 ... 400)
Register 100	R/W	Read and write S-Bus address for dynamic readdressing (0 ... 252)
Register 101	R/W	Secondary address (253) enable time out in seconds for commissioning, address set up
Register 102-103	R	Serial Number (high-low word)
Register 104-105	R	Firmware Version in Hex (BCD: 1.02.01 = 00010201 Hex) (high-low word)

## Order details

Type	Short description	Description	Weight
PCD7.D1000	Wall Unit	Wall Unit for temperature measurement, set point offset control with serial S-Bus and Modbus communication interface.	68 g
<b>Accessories</b>			
PCD7.L670	Wall Unit Cable RJ9 / RJ9 10 m	Wall Unit cable with 2 RJ9 connector at the end, 10 m	100 g

The mentioned above products complies with the following request:

The following directives will be applicable:

- ROHS: Restriction of Hazardous Substances 2002/95/EC and 2011/65/EC with respect to allowed exemptions foreseen under "8b: Cadmium and its compounds in electrical contacts"
- WEEE: Waste Electrical and Electronic Equipment 2002/96/EC
- Low Voltage Electrical Equipment 2006/95/EC



### Saia-Burgess Controls AG

Bahnhofstrasse 18 | 3280 Murten, Switzerland  
 T +41 26 580 30 00 | F +41 26 580 34 99  
 www.saia-pcd.com

support@saia-pcd.com | www.sbc-support.com